

MMBT5401W

High Voltage Transistor

PNP Silicon

Features

- NSV Prefix for Automotive and Other Applications Requiring Unique Site and Control Change Requirements; AEC-Q101 Qualified and PPAP Capable
- These Devices are Pb-Free, Halogen Free/BFR Free and are RoHS Compliant

MAXIMUM RATINGS

Rating	Symbol	Value	Unit
Collector-Emitter Voltage	V_{CEO}	-150	Vdc
Collector-Base Voltage	V_{CBO}	-160	Vdc
Emitter-Base Voltage	V_{EBO}	-5.0	Vdc
Collector Current - Continuous	I_C	-500	mAdc

Stresses exceeding those listed in the Maximum Ratings table may damage the device. If any of these limits are exceeded, device functionality should not be assumed, damage may occur and reliability may be affected.

THERMAL CHARACTERISTICS

Characteristic	Symbol	Max	Unit
Total Device Dissipation FR-5 Board (Note 2) $T_A = 25^\circ\text{C}$ Derate Above 25°C	P_D	400	mW
		3.2	mW/ $^\circ\text{C}$
Thermal Resistance, Junction-to-Ambient	$R_{\theta JA}$	312	$^\circ\text{C}/\text{W}$
Junction and Storage Temperature	T_J, T_{stg}	-55 to +150	$^\circ\text{C}$

1. FR-5 @ 100 mm², 0.5 oz. copper traces, still air.
2. FR-5 = 1.0 × 0.75 × 0.062 in.



ON Semiconductor®

www.onsemi.com

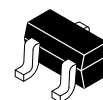
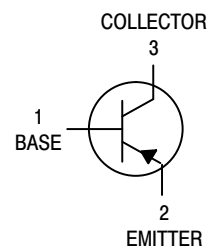

SC-70 (SOT-323)
CASE 419
STYLE 3

MARKING DIAGRAM

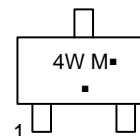

4W = Specific Device Code
M = Date Code*
▪ = Pb-Free Package

(Note: Microdot may be in either location)

*Date Code orientation and/or overbar may vary depending upon manufacturing location.

ORDERING INFORMATION

Device	Package	Shipping†
MMBT5401WT1G, NSVMMBT5401WT1G	SC-70 (Pb-Free)	3000 / Tape & Reel

†For information on tape and reel specifications, including part orientation and tape sizes, please refer to our Tape and Reel Packaging Specifications Brochure, BRD8011/D.

MMBT5401W

ELECTRICAL CHARACTERISTICS ($T_A = 25^\circ\text{C}$ unless otherwise noted)

Characteristic	Symbol	Min	Max	Unit
----------------	--------	-----	-----	------

OFF CHARACTERISTICS

Collector–Emitter Breakdown Voltage ($I_C = -1.0\text{ mA}$, $I_B = 0$)	$V_{(BR)CEO}$	-150	–	Vdc
Collector–Base Breakdown Voltage ($I_C = -100\text{ }\mu\text{A}$, $I_E = 0$)	$V_{(BR)CBO}$	-160	–	Vdc
Emitter–Base Breakdown Voltage ($I_E = -10\text{ }\mu\text{A}$, $I_C = 0$)	$V_{(BR)EBO}$	-5.0	–	Vdc
Collector–Base Cutoff Current ($V_{CB} = -120\text{ Vdc}$, $I_E = 0$) ($V_{CB} = -120\text{ Vdc}$, $I_E = 0$, $T_A = 100^\circ\text{C}$)	I_{CBO}	–	-50	nA μA

ON CHARACTERISTICS

DC Current Gain ($I_C = -1.0\text{ mA}$, $V_{CE} = -5.0\text{ Vdc}$) ($I_C = -10\text{ mA}$, $V_{CE} = -5.0\text{ Vdc}$) ($I_C = -50\text{ mA}$, $V_{CE} = -5.0\text{ Vdc}$)	h_{FE}	50 60 50	– 240 –	–
Collector–Emitter Saturation Voltage ($I_C = -10\text{ mA}$, $I_B = -1.0\text{ mA}$) ($I_C = -50\text{ mA}$, $I_B = -5.0\text{ mA}$)	$V_{CE(sat)}$	– –	-0.2 -0.5	Vdc
Base–Emitter Saturation Voltage ($I_C = -10\text{ mA}$, $I_B = -1.0\text{ mA}$) ($I_C = -50\text{ mA}$, $I_B = -5.0\text{ mA}$)	$V_{BE(sat)}$	– –	-1.0 -1.0	Vdc

SMALL–SIGNAL CHARACTERISTICS

Current–Gain — Bandwidth Product ($I_C = -10\text{ mA}$, $V_{CE} = -10\text{ Vdc}$, $f = 100\text{ MHz}$)	f_T	100	300	MHz
Output Capacitance ($V_{CB} = -10\text{ Vdc}$, $I_E = 0$, $f = 1.0\text{ MHz}$)	C_{obo}	–	6.0	pF
Small Signal Current Gain ($I_C = -1.0\text{ mA}$, $V_{CE} = -10\text{ Vdc}$, $f = 1.0\text{ kHz}$)	h_{fe}	40	200	–
Noise Figure ($I_C = -200\text{ }\mu\text{A}$, $V_{CE} = -5.0\text{ Vdc}$, $R_S = 10\text{ }\Omega$, $f = 1.0\text{ kHz}$)	NF	–	8.0	dB

Product parametric performance is indicated in the Electrical Characteristics for the listed test conditions, unless otherwise noted. Product performance may not be indicated by the Electrical Characteristics if operated under different conditions.

MMBT5401W

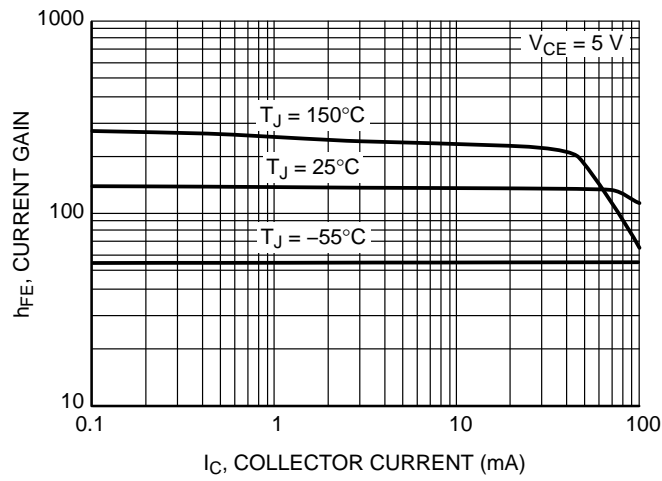

Figure 1. DC Current Gain

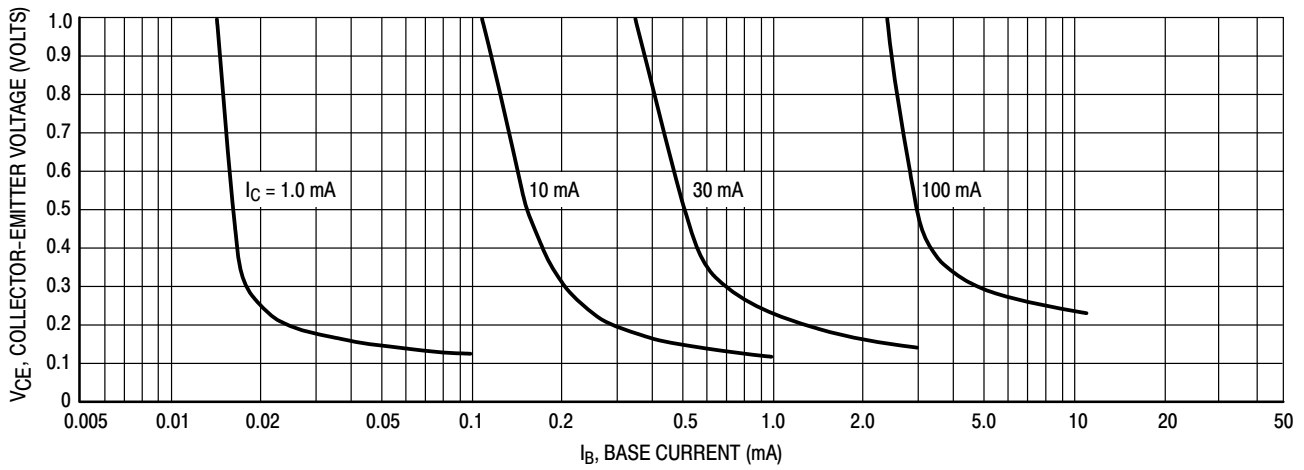

Figure 2. Collector Saturation Region

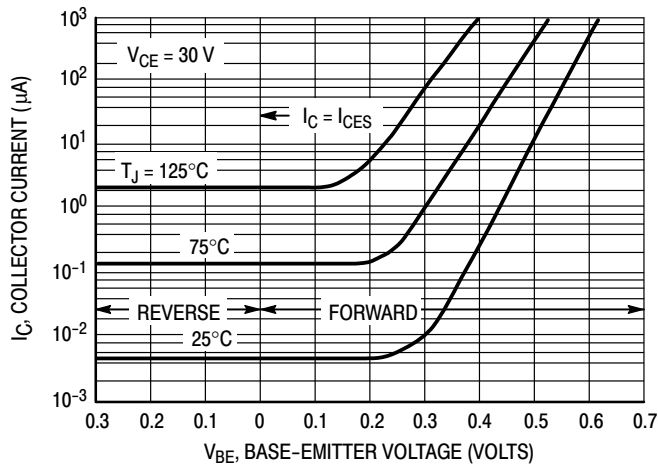

Figure 3. Collector Cut-Off Region

MMBT5401W

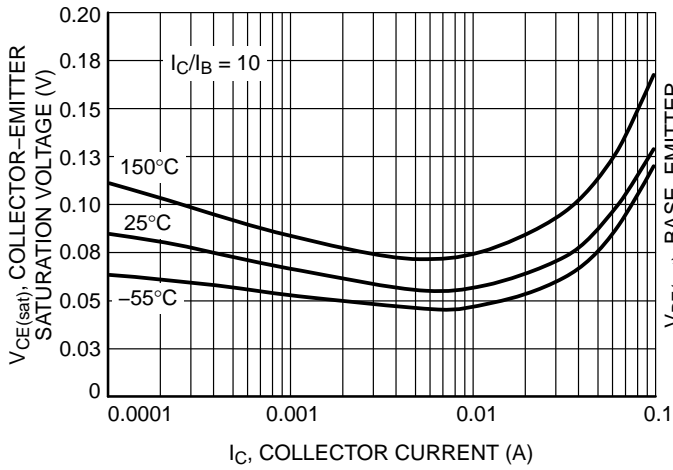

Figure 4. Collector-Emitter Saturation Voltage vs. Collector Current

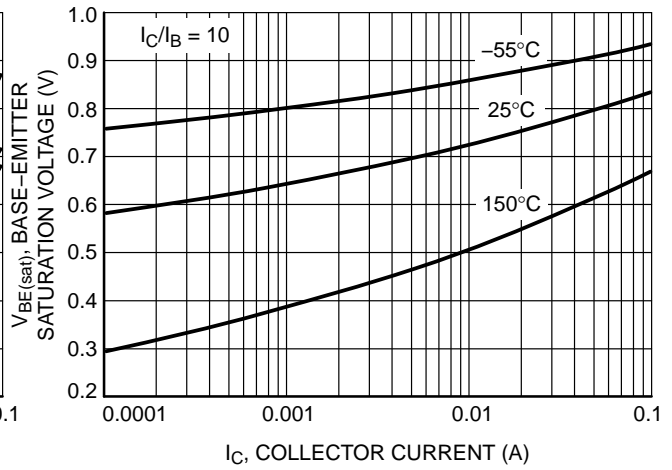

Figure 5. Base-Emitter Saturation Voltage vs. Collector Current

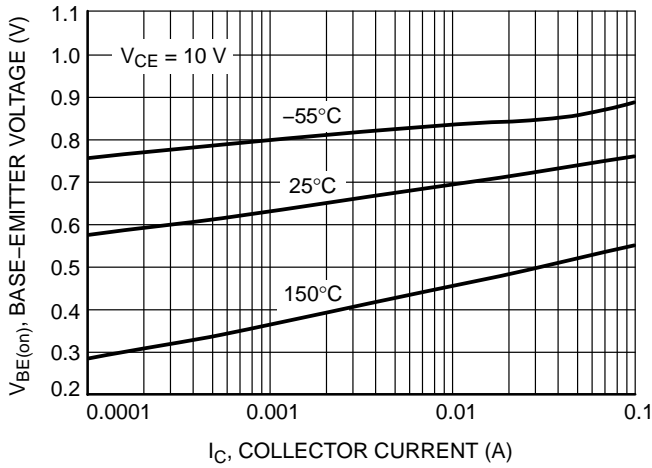

Figure 6. Base-Emitter Voltage vs. Collector Current

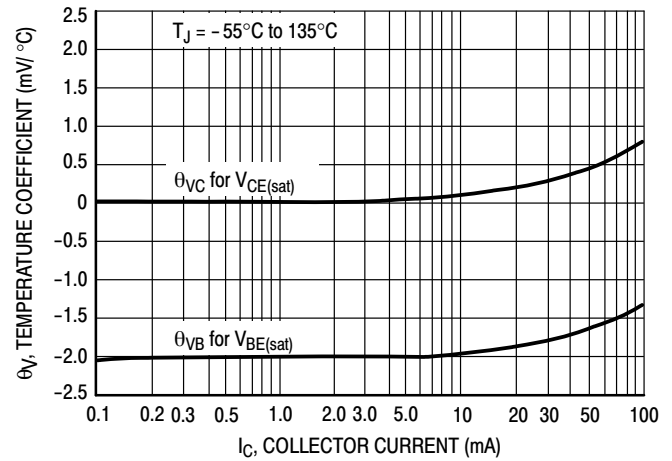
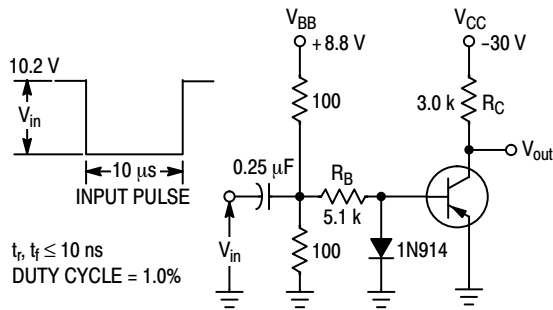

Figure 7. Temperature Coefficients



Values Shown are for I_C @ 10 mA

Figure 8. Switching Time Test Circuit

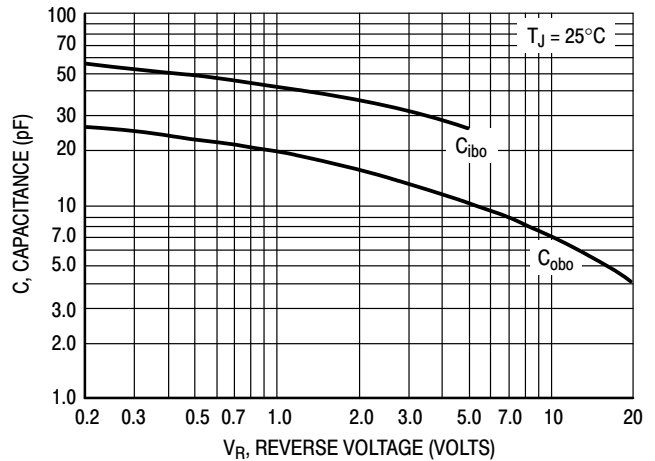

Figure 9. Capacitances

MMBT5401W

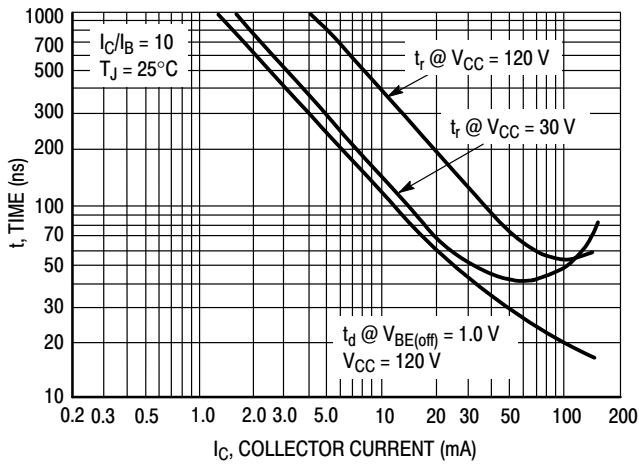

Figure 10. Turn-On Time

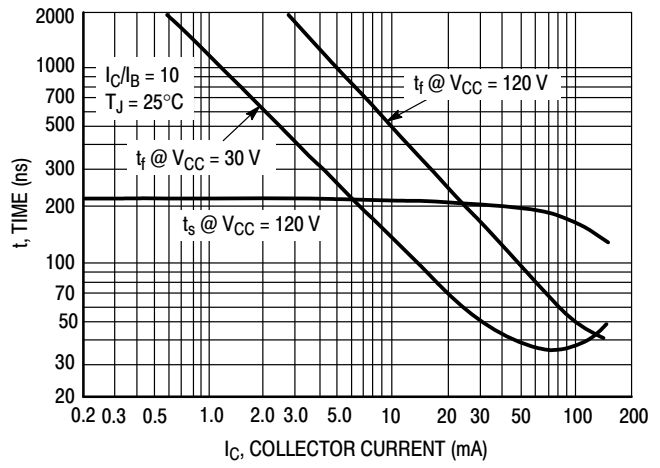

Figure 11. Turn-Off Time

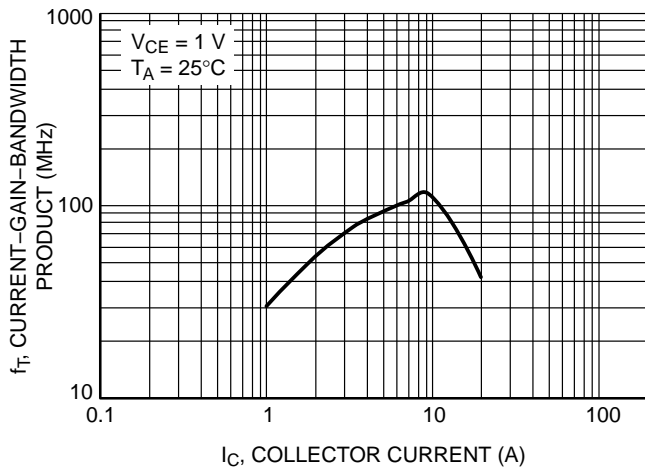

Figure 12. Current Gain Bandwidth Product

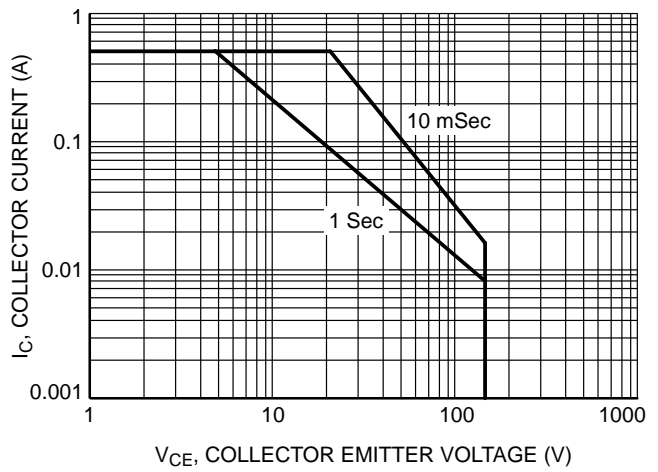

Figure 13. Safe Operating Area

MECHANICAL CASE OUTLINE PACKAGE DIMENSIONS



SCALE 4:1

SC-70 (SOT-323)
CASE 419
ISSUE P

DATE 07 OCT 2021

NOTES:

1. DIMENSIONING AND TOLERANCING PER ASME Y14.5M, 1982.
2. CONTROLLING DIMENSION: INCH

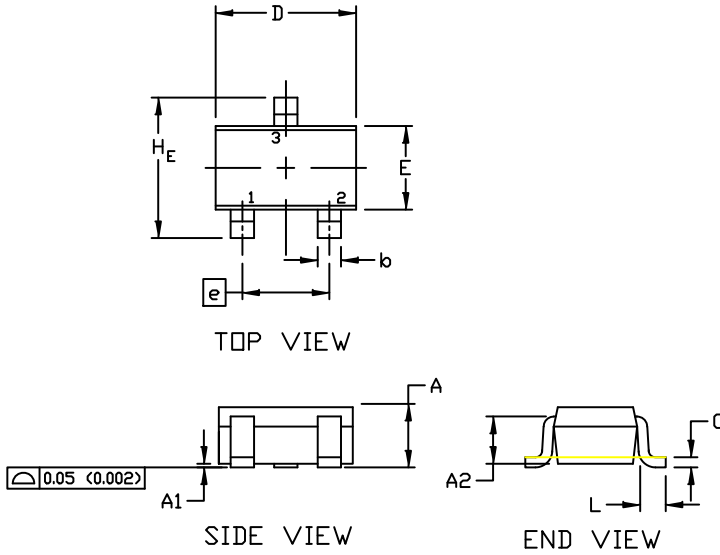

DIM	MILLIMETERS			INCHES		
	MIN.	NDM.	MAX.	MIN.	NDM.	MAX.
A	0.80	0.90	1.00	0.032	0.035	0.040
A1	0.00	0.05	0.10	0.000	0.002	0.004
A2	0.70 REF			0.028 BSC		
b	0.30	0.35	0.40	0.012	0.014	0.016
c	0.10	0.18	0.25	0.004	0.007	0.010
D	1.80	2.10	2.20	0.071	0.083	0.087
E	1.15	1.24	1.35	0.045	0.049	0.053
e	1.20	1.30	1.40	0.047	0.051	0.055
e1	0.65 BSC			0.026 BSC		
L	0.20	0.38	0.56	0.008	0.015	0.022
H _E	2.00	2.10	2.40	0.079	0.083	0.095

GENERIC MARKING DIAGRAM

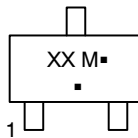

- XX = Specific Device Code
- M = Date Code
- = Pb-Free Package

*This information is generic. Please refer to device data sheet for actual part marking. Pb-Free indicator, "G" or microdot "■", may or may not be present. Some products may not follow the Generic Marking.

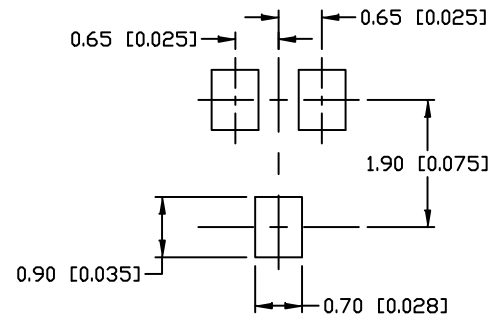

* For additional information on our Pb-Free strategy and soldering details, please download the DN Semiconductor Soldering and Mounting Techniques Reference Manual, SOLDERRM/D.

SOLDERING FOOTPRINT

- STYLE 1:
CANCELLED
- STYLE 2:
PIN 1. ANODE
2. N.C.
3. CATHODE
- STYLE 3:
PIN 1. BASE
2. EMITTER
3. COLLECTOR
- STYLE 4:
PIN 1. CATHODE
2. CATHODE
3. ANODE
- STYLE 5:
PIN 1. ANODE
2. ANODE
3. CATHODE
- STYLE 6:
PIN 1. EMITTER
2. BASE
3. COLLECTOR
- STYLE 7:
PIN 1. BASE
2. EMITTER
3. COLLECTOR
- STYLE 8:
PIN 1. GATE
2. SOURCE
3. DRAIN
- STYLE 9:
PIN 1. ANODE
2. CATHODE
3. CATHODE-ANODE
- STYLE 10:
PIN 1. CATHODE
2. ANODE
3. ANODE-CATHODE
- STYLE 11:
PIN 1. CATHODE
2. CATHODE
3. CATHODE

DOCUMENT NUMBER:	98ASB42819B	Electronic versions are uncontrolled except when accessed directly from the Document Repository. Printed versions are uncontrolled except when stamped "CONTROLLED COPY" in red.
DESCRIPTION:	SC-70 (SOT-323)	PAGE 1 OF 1

onsemi and ONSEMI are trademarks of Semiconductor Components Industries, LLC dba onsemi or its subsidiaries in the United States and/or other countries. onsemi reserves the right to make changes without further notice to any products herein. onsemi makes no warranty, representation or guarantee regarding the suitability of its products for any particular purpose, nor does onsemi assume any liability arising out of the application or use of any product or circuit, and specifically disclaims any and all liability, including without limitation special, consequential or incidental damages. onsemi does not convey any license under its patent rights nor the rights of others.

onsemi, **Onsemi**, and other names, marks, and brands are registered and/or common law trademarks of Semiconductor Components Industries, LLC dba "**onsemi**" or its affiliates and/or subsidiaries in the United States and/or other countries. **onsemi** owns the rights to a number of patents, trademarks, copyrights, trade secrets, and other intellectual property. A listing of **onsemi**'s product/patent coverage may be accessed at www.onsemi.com/site/pdf/Patent-Marking.pdf. **onsemi** reserves the right to make changes at any time to any products or information herein, without notice. The information herein is provided "as-is" and **onsemi** makes no warranty, representation or guarantee regarding the accuracy of the information, product features, availability, functionality, or suitability of its products for any particular purpose, nor does **onsemi** assume any liability arising out of the application or use of any product or circuit, and specifically disclaims any and all liability, including without limitation special, consequential or incidental damages. Buyer is responsible for its products and applications using **onsemi** products, including compliance with all laws, regulations and safety requirements or standards, regardless of any support or applications information provided by **onsemi**. "Typical" parameters which may be provided in **onsemi** data sheets and/or specifications can and do vary in different applications and actual performance may vary over time. All operating parameters, including "Typicals" must be validated for each customer application by customer's technical experts. **onsemi** does not convey any license under any of its intellectual property rights nor the rights of others. **onsemi** products are not designed, intended, or authorized for use as a critical component in life support systems or any FDA Class 3 medical devices or medical devices with a same or similar classification in a foreign jurisdiction or any devices intended for implantation in the human body. Should Buyer purchase or use **onsemi** products for any such unintended or unauthorized application, Buyer shall indemnify and hold **onsemi** and its officers, employees, subsidiaries, affiliates, and distributors harmless against all claims, costs, damages, and expenses, and reasonable attorney fees arising out of, directly or indirectly, any claim of personal injury or death associated with such unintended or unauthorized use, even if such claim alleges that **onsemi** was negligent regarding the design or manufacture of the part. **onsemi** is an Equal Opportunity/Affirmative Action Employer. This literature is subject to all applicable copyright laws and is not for resale in any manner.

PUBLICATION ORDERING INFORMATION

LITERATURE FULFILLMENT:

Email Requests to: orderlit@onsemi.com

onsemi Website: www.onsemi.com

TECHNICAL SUPPORT

North American Technical Support:

Voice Mail: 1 800-282-9855 Toll Free USA/Canada

Phone: 011 421 33 790 2910

Europe, Middle East and Africa Technical Support:

Phone: 00421 33 790 2910

For additional information, please contact your local Sales Representative