

N-Channel General-Purpose Amplifier

MMBFJ201, MMBFJ202

Description

This device is designed primarily for low level audio and general-purpose applications with high impedance signal sources. Sourced from process 52.

Applications

- These are Pb-Free Devices

ABSOLUTE MAXIMUM RATINGS ($T_A = 25^\circ\text{C}$ unless otherwise noted) (Note 1, 2)

Symbol	Parameter	Value	Unit
V_{DG}	Drain-Gate Voltage	40	V
V_{GS}	Gate-Source Voltage	-40	V
I_{GF}	Forward Gate Current	50	mA
T_J, T_{STG}	Operating and Storage Junction Temperature Range	-55 to 150	$^\circ\text{C}$

Stresses exceeding those listed in the Maximum Ratings table may damage the device. If any of these limits are exceeded, device functionality should not be assumed, damage may occur and reliability may be affected.

1. These ratings are based on a maximum junction temperature of 150°C .
2. These are steady-state limits. ON Semiconductor should be consulted on applications involving pulsed or low-duty-cycle operations.

THERMAL CHARACTERISTICS ($T_A = 25^\circ\text{C}$ unless otherwise noted) (Note 3)

Symbol	Parameter	Max	Unit
P_D	Total Device Dissipation	350	mW
	Derate Above 25°C	2.8	mW/ $^\circ\text{C}$
$R_{\theta JA}$	Thermal Resistance, Junction-to-Ambient	357	$^\circ\text{C}/\text{W}$

3. Device mounted on FR-4 PCB 36 mm x 18 mm x 1.5 mm; mounting pad for the collector lead minimum 6 cm².



ON Semiconductor®

www.onsemi.com

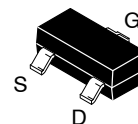

SOT-23 (TO-236)
CASE 318-08

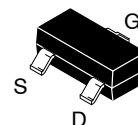

SOT-23
CASE 318BM

MARKING DIAGRAMS

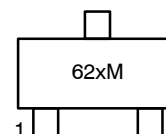

62x = Specific Device Code
x = P or Q
M = Date Code

ORDERING INFORMATION

See detailed ordering and shipping information on page 5 of this data sheet.

MMBFJ201, MMBFJ202

ELECTRICAL CHARACTERISTICS (T_A = 25°C unless otherwise noted)

Symbol	Parameter	Test Condition	Min	Max	Unit
--------	-----------	----------------	-----	-----	------

OFF CHARACTERISTICS

V _{(BR)GSS}	Gate-Source Breakdown Voltage	I _G = -1.0 μA, V _{DS} = 0	-40	-	V	
I _{GSS}	Gate Reverse Current	V _{GS} = -20 V, V _{DS} = 0	-	-100	pA	
V _{GS(off)}	Gate-Source Cut-Off Voltage	V _{DS} = 20 V, I _D = 10 nA	MMBFJ201	-0.3	-1.5	V
			MMBFJ202	-0.8	-4.0	

ON CHARACTERISTICS

I _{DSS}	Zero-Gate Voltage Drain Current (Note 4)	V _{DS} = 20 V, I _{GS} = 0	MMBFJ201	0.2	1.0	mA
			MMBFJ202	0.9	4.5	

SMALL SIGNAL CHARACTERISTICS

y _{FS}	Forward Transfer Admittance	V _{DS} = 20 V, f = 1.0 kHz	MMBFJ201	500		μmhos
			MMBFJ202	1000		

Product parametric performance is indicated in the Electrical Characteristics for the listed test conditions, unless otherwise noted. Product performance may not be indicated by the Electrical Characteristics if operated under different conditions.

4. Pulse test: pulse width ≤ 300 μs, duty cycle ≤ 2%.

MMBFJ201, MMBFJ202

TYPICAL PERFORMANCE CHARACTERISTICS

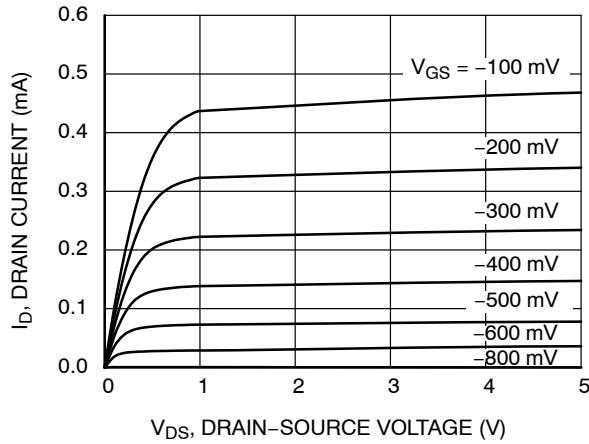

Figure 1. Common Drain-Source (MMBFJ201)

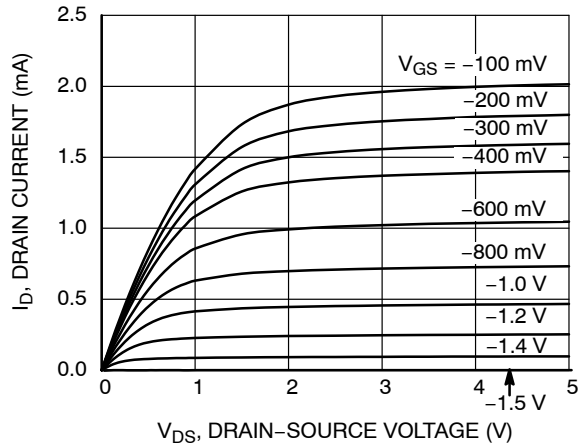

Figure 2. Common Drain-Source (MMBFJ202)

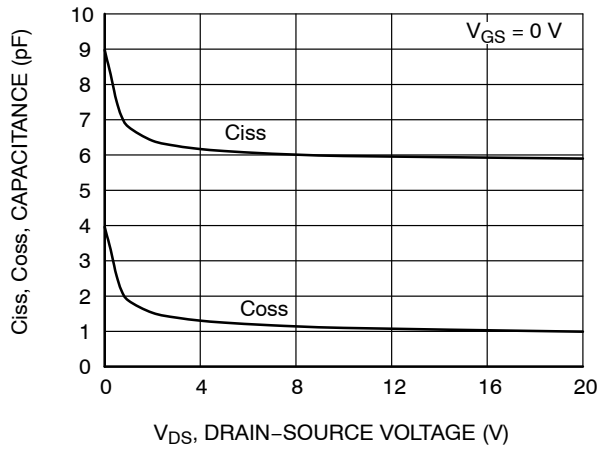

Figure 3. Capacitance vs. Voltage (MMBFJ201)

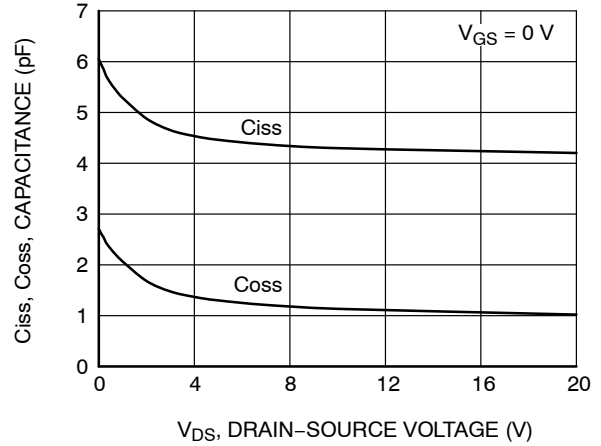

Figure 4. Capacitance vs. Voltage (MMBFJ202)

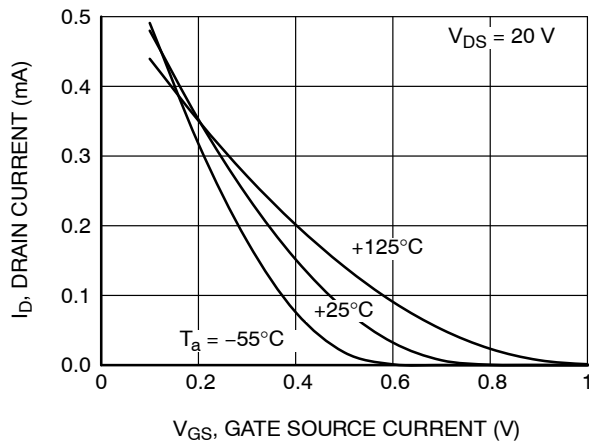

Figure 5. Transfer Characteristics (MMBFJ201)

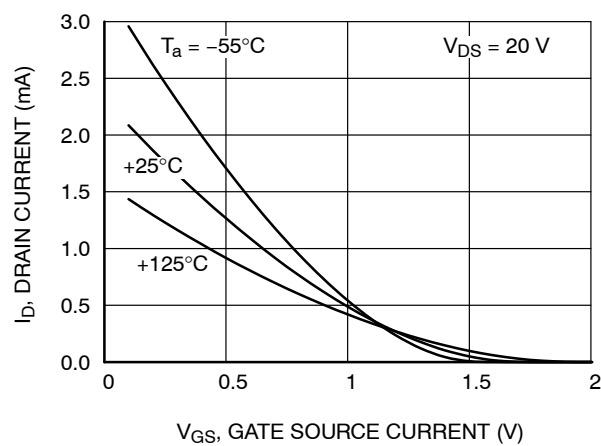

Figure 6. Transfer Characteristics (MMBFJ202)

MMBFJ201, MMBFJ202

TYPICAL PERFORMANCE CHARACTERISTICS (Continued)

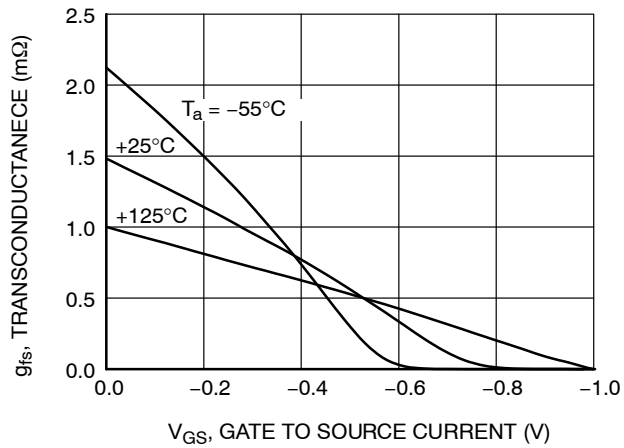

Figure 7. Transfer Characteristics (MMBFJ201)

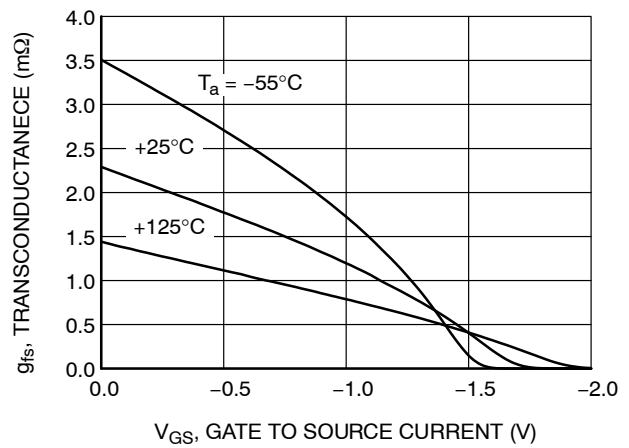

Figure 8. Transfer Characteristics (MMBFJ202)

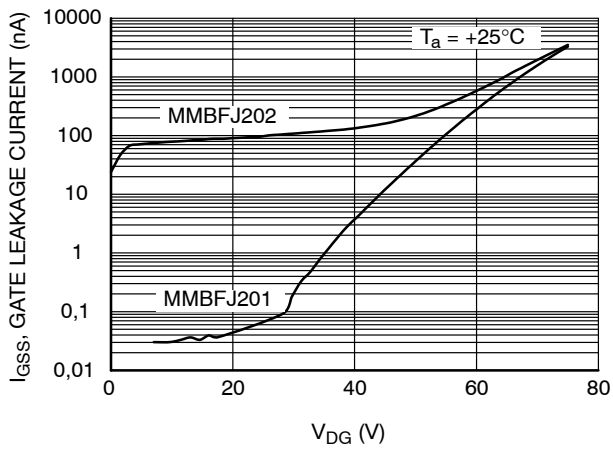

Figure 9. Leakage Current vs. Voltage

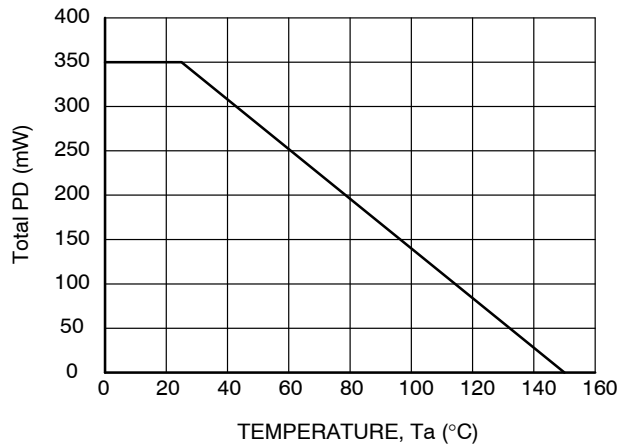

Figure 10. Total PD vs. Temperature

MMBFJ201, MMBFJ202

ORDERING INFORMATION

Part Number	Top Mark	Package	Shipping [†]
MMBFJ201	62P	SOT-23 (Pb-Free)	3000 / Tape & Reel
MMBFJ202	62Q	SOT-23 (TO-236) (Pb-Free)	3000 / Tape & Reel

[†]For information on tape and reel specifications, including part orientation and tape sizes, please refer to our Tape and Reel Packaging Specifications Brochure, BRD8011/D.

MECHANICAL CASE OUTLINE

PACKAGE DIMENSIONS

ON Semiconductor®



SOT-23 (TO-236) CASE 318-08 ISSUE AS

DATE 30 JAN 2018

SCALE 4:1



NOTES:

1. DIMENSIONING AND TOLERANCING PER ASME Y14.5M, 1994.
2. CONTROLLING DIMENSION: MILLIMETERS.
3. MAXIMUM LEAD THICKNESS INCLUDES LEAD FINISH. MINIMUM LEAD THICKNESS IS THE MINIMUM THICKNESS OF THE BASE MATERIAL.
4. DIMENSIONS D AND E DO NOT INCLUDE MOLD FLASH, PROTRUSIONS, OR GATE BURRS.

DIM	MILLIMETERS			INCHES		
	MIN	NOM	MAX	MIN	NOM	MAX
A	0.89	1.00	1.11	0.035	0.039	0.044
A1	0.01	0.06	0.10	0.000	0.002	0.004
b	0.37	0.44	0.50	0.015	0.017	0.020
c	0.08	0.14	0.20	0.003	0.006	0.008
D	2.80	2.90	3.04	0.110	0.114	0.120
E	1.20	1.30	1.40	0.047	0.051	0.055
e	1.78	1.90	2.04	0.070	0.075	0.080
L	0.30	0.43	0.55	0.012	0.017	0.022
L1	0.35	0.54	0.69	0.014	0.021	0.027
HE	2.10	2.40	2.64	0.083	0.094	0.104
T	0°	---	10°	0°	---	10°

RECOMMENDED SOLDERING FOOTPRINT



GENERIC MARKING DIAGRAM*



XXX = Specific Device Code
M = Date Code
▪ = Pb-Free Package

*This information is generic. Please refer to device data sheet for actual part marking. Pb-Free indicator, "G" or microdot "▪", may or may not be present.

STYLE 1 THRU 5:
CANCELLED

STYLE 6:
PIN 1. BASE
2. EMITTER
3. COLLECTOR

STYLE 7:
PIN 1. EMITTER
2. BASE
3. COLLECTOR

STYLE 8:
PIN 1. ANODE
2. NO CONNECTION
3. CATHODE

STYLE 9:
PIN 1. ANODE
2. ANODE
3. CATHODE

STYLE 10:
PIN 1. DRAIN
2. SOURCE
3. GATE

STYLE 11:
PIN 1. ANODE
2. CATHODE
3. CATHODE-ANODE

STYLE 12:
PIN 1. CATHODE
2. CATHODE
3. ANODE

STYLE 13:
PIN 1. SOURCE
2. DRAIN
3. GATE

STYLE 14:
PIN 1. CATHODE
2. GATE
3. ANODE

STYLE 15:
PIN 1. GATE
2. CATHODE
3. ANODE

STYLE 16:
PIN 1. ANODE
2. CATHODE
3. CATHODE

STYLE 17:
PIN 1. NO CONNECTION
2. ANODE
3. CATHODE

STYLE 18:
PIN 1. NO CONNECTION
2. CATHODE
3. ANODE

STYLE 19:
PIN 1. CATHODE
2. ANODE
3. CATHODE-ANODE

STYLE 20:
PIN 1. CATHODE
2. ANODE
3. GATE

STYLE 21:
PIN 1. GATE
2. SOURCE
3. DRAIN

STYLE 22:
PIN 1. RETURN
2. OUTPUT
3. INPUT

STYLE 23:
PIN 1. ANODE
2. ANODE
3. CATHODE

STYLE 24:
PIN 1. GATE
2. DRAIN
3. SOURCE

STYLE 25:
PIN 1. ANODE
2. CATHODE
3. GATE

STYLE 26:
PIN 1. CATHODE
2. ANODE
3. NO CONNECTION

STYLE 27:
PIN 1. CATHODE
2. CATHODE
3. CATHODE

STYLE 28:
PIN 1. ANODE
2. ANODE
3. ANODE

DOCUMENT NUMBER:	98ASB42226B	Electronic versions are uncontrolled except when accessed directly from the Document Repository. Printed versions are uncontrolled except when stamped "CONTROLLED COPY" in red.
DESCRIPTION:	SOT-23 (TO-236)	PAGE 1 OF 1

ON Semiconductor and ON are trademarks of Semiconductor Components Industries, LLC dba ON Semiconductor or its subsidiaries in the United States and/or other countries. ON Semiconductor reserves the right to make changes without further notice to any products herein. ON Semiconductor makes no warranty, representation or guarantee regarding the suitability of its products for any particular purpose, nor does ON Semiconductor assume any liability arising out of the application or use of any product or circuit, and specifically disclaims any and all liability, including without limitation special, consequential or incidental damages. ON Semiconductor does not convey any license under its patent rights nor the rights of others.

MECHANICAL CASE OUTLINE PACKAGE DIMENSIONS

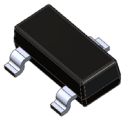

SOT-23
CASE 318BM
ISSUE A

DATE 01 SEP 2021

NOTES: UNLESS OTHERWISE SPECIFIED

- A) REFERENCE JEDEC REGISTRATION TO-236, VARIATION AB, ISSUE H.
- B) ALL DIMENSIONS ARE IN MILLIMETERS.
- C) DIMENSIONS ARE INCLUSIVE OF BURRS, MOLD FLASH AND TIE BAR EXTRUSIONS.
- D) DIMENSIONING AND TOLERANCING PER ASME Y14.5M - 2009.

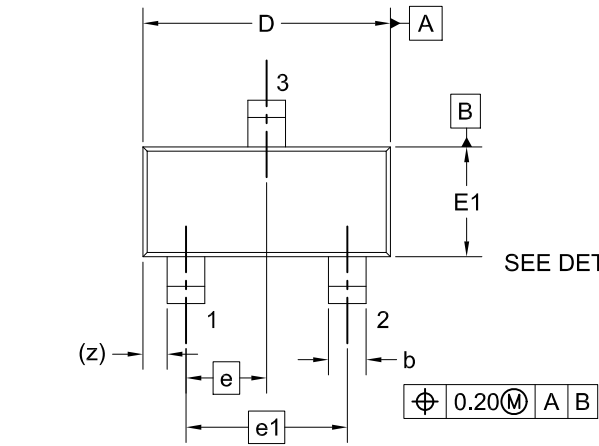

SEE DETAIL A

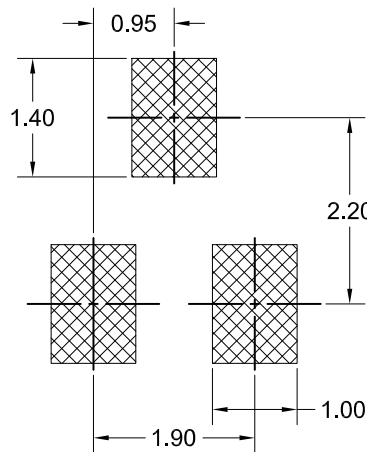
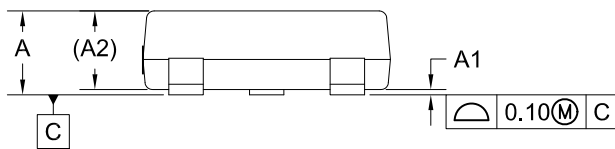
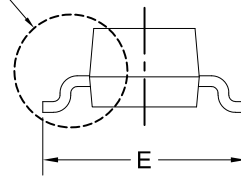

DIM	MILLIMETERS		
	MIN.	NOM.	MAX.
A	---	---	1.20
A1	0.00	0.05	0.10
A2	0.93 REF		
b	0.37	0.44	0.60
c	0.08	0.15	0.23
D	2.72	2.92	3.12
E	2.10	2.40	2.70
E1	1.15	1.30	1.50
e	0.95 BSC		
e1	1.90 BSC		
L	0.20	---	---
L1	0.55 REF		
z	0.29 REF		

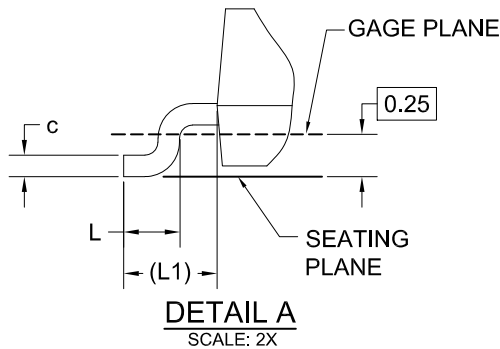

LAND PATTERN
RECOMMENDATION

*FOR ADDITIONAL INFORMATION ON OUR PB-FREE STRATEGY AND SOLDERING DETAILS, PLEASE DOWNLOAD THE ON SEMICONDUCTOR SOLDERING AND MOUNTING TECHNIQUES REFERENCE MANUAL, SOLDERRM/D.

GENERIC MARKING DIAGRAM*

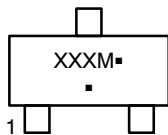

- XXX = Specific Device Code
- M = Date Code
- = Pb-Free Package

*This information is generic. Please refer to device data sheet for actual part marking. Pb-Free indicator, "G" or microdot "▪", may or may not be present. Some products may not follow the Generic Marking.

DOCUMENT NUMBER:	98AON13784G	Electronic versions are uncontrolled except when accessed directly from the Document Repository. Printed versions are uncontrolled except when stamped "CONTROLLED COPY" in red.
DESCRIPTION:	SOT-23	PAGE 1 OF 1

onsemi and ONSEMI are trademarks of Semiconductor Components Industries, LLC dba onsemi or its subsidiaries in the United States and/or other countries. onsemi reserves the right to make changes without further notice to any products herein. onsemi makes no warranty, representation or guarantee regarding the suitability of its products for any particular purpose, nor does onsemi assume any liability arising out of the application or use of any product or circuit, and specifically disclaims any and all liability, including without limitation special, consequential or incidental damages. onsemi does not convey any license under its patent rights nor the rights of others.

onsemi, **Onsemi**, and other names, marks, and brands are registered and/or common law trademarks of Semiconductor Components Industries, LLC dba "**onsemi**" or its affiliates and/or subsidiaries in the United States and/or other countries. **onsemi** owns the rights to a number of patents, trademarks, copyrights, trade secrets, and other intellectual property. A listing of **onsemi**'s product/patent coverage may be accessed at www.onsemi.com/site/pdf/Patent-Marking.pdf. **onsemi** reserves the right to make changes at any time to any products or information herein, without notice. The information herein is provided "as-is" and **onsemi** makes no warranty, representation or guarantee regarding the accuracy of the information, product features, availability, functionality, or suitability of its products for any particular purpose, nor does **onsemi** assume any liability arising out of the application or use of any product or circuit, and specifically disclaims any and all liability, including without limitation special, consequential or incidental damages. Buyer is responsible for its products and applications using **onsemi** products, including compliance with all laws, regulations and safety requirements or standards, regardless of any support or applications information provided by **onsemi**. "Typical" parameters which may be provided in **onsemi** data sheets and/or specifications can and do vary in different applications and actual performance may vary over time. All operating parameters, including "Typicals" must be validated for each customer application by customer's technical experts. **onsemi** does not convey any license under any of its intellectual property rights nor the rights of others. **onsemi** products are not designed, intended, or authorized for use as a critical component in life support systems or any FDA Class 3 medical devices or medical devices with a same or similar classification in a foreign jurisdiction or any devices intended for implantation in the human body. Should Buyer purchase or use **onsemi** products for any such unintended or unauthorized application, Buyer shall indemnify and hold **onsemi** and its officers, employees, subsidiaries, affiliates, and distributors harmless against all claims, costs, damages, and expenses, and reasonable attorney fees arising out of, directly or indirectly, any claim of personal injury or death associated with such unintended or unauthorized use, even if such claim alleges that **onsemi** was negligent regarding the design or manufacture of the part. **onsemi** is an Equal Opportunity/Affirmative Action Employer. This literature is subject to all applicable copyright laws and is not for resale in any manner.

PUBLICATION ORDERING INFORMATION

LITERATURE FULFILLMENT:

Email Requests to: orderlit@onsemi.com

onsemi Website: www.onsemi.com

TECHNICAL SUPPORT

North American Technical Support:

Voice Mail: 1 800-282-9855 Toll Free USA/Canada

Phone: 011 421 33 790 2910

Europe, Middle East and Africa Technical Support:

Phone: 00421 33 790 2910

For additional information, please contact your local Sales Representative