

MC74HC11A

Triple 3-Input AND Gate

High-Performance Silicon-Gate CMOS

The MC74HC11A is identical in pinout to the LS11. The device inputs are compatible with standard CMOS outputs; with pullup resistors, they are compatible with LSTTL outputs.

Features

- Output Drive Capability: 10 LSTTL Loads
- Outputs Directly Interface to CMOS, NMOS, and TTL
- Operating Voltage Range: 2 V to 6 V
- Low Input Current: 1 μ A
- High Noise Immunity Characteristic of CMOS Devices
- NLV Prefix for Automotive and Other Applications Requiring Unique Site and Control Change Requirements; AEC-Q100 Qualified and PPAP Capable
- These Devices are Pb-Free, Halogen Free and are RoHS Compliant

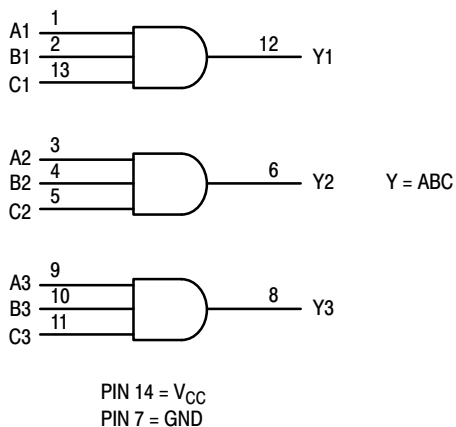

Figure 1. Logic Diagram



ON Semiconductor®

<http://onsemi.com>

MARKING DIAGRAMS

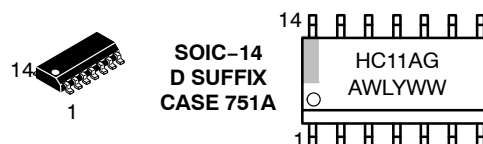

A = Assembly Location
WL, L = Wafer Lot
YY, Y = Year
WW, W = Work Week
G or ■ = Pb-Free Package

(Note: Microdot may be in either location)

PIN ASSIGNMENT

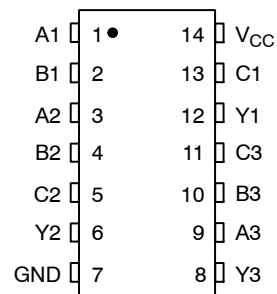

FUNCTION TABLE

| Inputs | | | Output |
|--------|---|---|--------|
| A | B | C | Y |
| L | X | X | L |
| X | L | X | L |
| X | X | L | L |
| H | H | H | H |

ORDERING INFORMATION

See detailed ordering and shipping information in the package dimensions section on page 4 of this data sheet.

MC74HC11A

MAXIMUM RATINGS*

| Symbol | Parameter | Value | Unit | |
|-----------|--|-------------------------------|--------------------|----|
| V_{CC} | DC Supply Voltage (Referenced to GND) | -0.5 to +7.0 | V | |
| V_{in} | DC Input Voltage (Referenced to GND) | -0.5 to $V_{CC} + 0.5$ | V | |
| V_{out} | DC Output Voltage (Referenced to GND) | -0.5 to $V_{CC} + 0.5$ | V | |
| I_{in} | DC Input Current, per Pin | ± 20 | mA | |
| I_{out} | DC Output Current, per Pin | ± 25 | mA | |
| I_{CC} | DC Supply Current, V_{CC} and GND Pins | ± 50 | mA | |
| P_D | Power Dissipation in Still Air | SOIC Package TSSOP Package | 500 450 | mW |
| T_{stg} | Storage Temperature | -65 to +150 | $^{\circ}\text{C}$ | |

Stresses exceeding Maximum Ratings may damage the device. Maximum Ratings are stress ratings only. Functional operation above the Recommended Operating Conditions is not implied. Extended exposure to stresses above the Recommended Operating Conditions may affect device reliability.

This device contains protection circuitry to guard against damage due to high static voltages or electric fields. However, precautions must be taken to avoid applications of any voltage higher than maximum rated voltages to this high-impedance circuit. For proper operation, V_{in} and V_{out} should be constrained to the range $\text{GND} \leq (V_{in} \text{ or } V_{out}) \leq V_{CC}$. Unused inputs must always be tied to an appropriate logic voltage level (e.g., either GND or V_{CC}). Unused outputs must be left open.

RECOMMENDED OPERATING CONDITIONS

| Symbol | Parameter | Min | Max | Unit | |
|-------------------|--|--|------------------|---------------------------|----|
| V_{CC} | DC Supply Voltage (Referenced to GND) | 2.0 | 6.0 | V | |
| V_{in}, V_{out} | DC Input Voltage, Output Voltage (Referenced to GND) | 0 | V_{CC} | V | |
| T_A | Operating Temperature, All Package Types | -55 | +125 | $^{\circ}\text{C}$ | |
| t_r, t_f | Input Rise and Fall Time (Figure 2) | $V_{CC} = 2.0 \text{ V}$ $V_{CC} = 3.0 \text{ V}$ $V_{CC} = 4.5 \text{ V}$ $V_{CC} = 6.0 \text{ V}$ | 0 0 0 0 | 1000 600 500 400 | ns |

MC74HC11A

DC ELECTRICAL CHARACTERISTICS (Voltages Referenced to GND)

| Symbol | Parameter | Test Conditions | V _{CC} V | Guaranteed Limit | | | Unit |
|-----------------|--|---|----------------------|------------------|--------|---------|------|
| | | | | - 55 to 25°C | ≤ 85°C | ≤ 125°C | |
| V _{IH} | Minimum High-Level Input Voltage | V _{out} = 0.1 V or V _{CC} - 0.1 V I _{out} ≤ 20 μA | 2.0 | 1.5 | 1.5 | 1.5 | V |
| | | | 3.0 | 2.1 | 2.1 | 2.1 | |
| | | | 4.5 | 3.15 | 3.15 | 3.15 | |
| | | | 6.0 | 4.2 | 4.2 | 4.2 | |
| V _{IL} | Maximum Low-Level Input Voltage | V _{out} = 0.1 V or V _{CC} - 0.1 V I _{out} ≤ 20 μA | 2.0 | 0.5 | 0.5 | 0.5 | V |
| | | | 3.0 | 0.9 | 0.9 | 0.9 | |
| | | | 4.5 | 1.35 | 1.35 | 1.35 | |
| | | | 6.0 | 1.8 | 1.8 | 1.8 | |
| V _{OH} | Minimum High-Level Output Voltage | V _{in} = V _{IH} or V _{IL} I _{out} ≤ 20 μA | 2.0 | 1.9 | 1.9 | 1.9 | V |
| | | | 4.5 | 4.4 | 4.4 | 4.4 | |
| | | | 6.0 | 5.9 | 5.9 | 5.9 | |
| | | V _{in} = V _{IH} or V _{IL} I _{out} ≤ 2.4 mA I _{out} ≤ 4.0 mA I _{out} ≤ 5.2 mA | 3.0 | 2.48 | 2.34 | 2.20 | |
| | | | 4.5 | 3.98 | 3.84 | 3.70 | |
| | | | 6.0 | 5.48 | 5.34 | 5.20 | |
| V _{OL} | Maximum Low-Level Output Voltage | V _{in} = V _{IH} I _{out} ≤ 20 μA | 2.0 | 0.1 | 0.1 | 0.1 | V |
| | | | 4.5 | 0.1 | 0.1 | 0.1 | |
| | | | 6.0 | 0.1 | 0.1 | 0.1 | |
| | | V _{in} = V _{IH} or V _{IL} I _{out} ≤ 2.4 mA I _{out} ≤ 4.0 mA I _{out} ≤ 5.2 mA | 3.0 | 0.26 | 0.33 | 0.40 | |
| | | | 4.5 | 0.26 | 0.33 | 0.40 | |
| | | | 6.0 | 0.26 | 0.33 | 0.40 | |
| I _{in} | Maximum Input Leakage Current | V _{in} = V _{CC} or GND | 6.0 | ± 0.1 | ± 1.0 | ± 1.0 | μA |
| I _{CC} | Maximum Quiescent Supply Current (per Package) | V _{in} = V _{CC} or GND I _{out} = 0 μA | 6.0 | 1 | 10 | 40 | μA |

AC ELECTRICAL CHARACTERISTICS (C_L = 50 pF, Input t_r = t_f = 6 ns)

| Symbol | Parameter | V _{CC} V | Guaranteed Limit | | | Unit |
|--|--|---|------------------|--------|---------|------|
| | | | - 55 to 25°C | ≤ 85°C | ≤ 125°C | |
| t _{PLH} , t _{PHL} | Maximum Propagation Delay, Input A, B, or C to Output Y (Figures 2 and 3) | 2.0 | 95 | 120 | 145 | ns |
| | | 3.0 | 45 | 60 | 75 | |
| | | 4.5 | 19 | 24 | 29 | |
| | | 6.0 | 16 | 20 | 25 | |
| t _{TLH} , t _{THL} | Maximum Output Transition Time, Any Output (Figures 2 and 3) | 2.0 | 75 | 95 | 110 | ns |
| | | 3.0 | 30 | 40 | 55 | |
| | | 4.5 | 15 | 19 | 22 | |
| | | 6.0 | 13 | 16 | 19 | |
| C _{in} | Maximum Input Capacitance | - | 10 | 10 | 10 | pF |
| C _{PD} | Power Dissipation Capacitance (Per Gate)* | Typical @ 25°C, V _{CC} = 5.0 V | | | pF | |
| | | 27 | | | | |

*Used to determine the no-load dynamic power consumption: P_D = C_{PD} V_{CC}2f + I_{CC} V_{CC}.

MC74HC11A

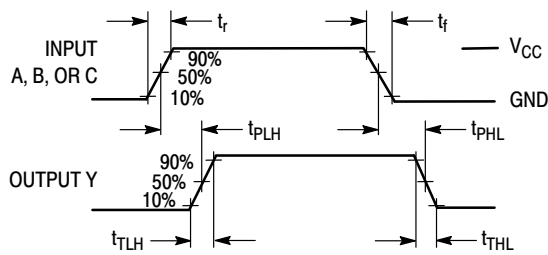

Figure 2. Switching Waveforms

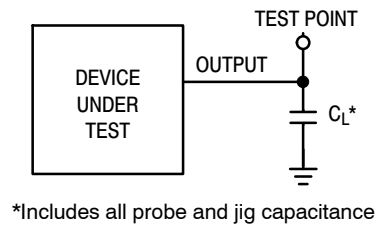

Figure 3. Test Circuit

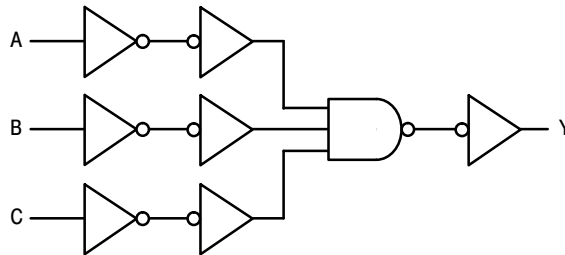

Figure 4. Expanded Logic Diagram (1/3 of the Device)

ORDERING INFORMATION

| Device | Package | Shipping† |
|-----------------|--------------------|--------------------|
| MC74HC11ADG | SOIC-14 (Pb-Free) | 55 Units / Rail |
| MC74HC11ADR2G | SOIC-14 (Pb-Free) | 2500 / Tape & Reel |
| MC74HC11ADTG | TSSOP-14 (Pb-Free) | 96 Units / Tube |
| MC74HC11ADTR2G | TSSOP-14 (Pb-Free) | 2500 / Tape & Reel |
| NLV74HC11ADR2G* | SOIC-14 (Pb-Free) | 2500 / Tape & Reel |

†For information on tape and reel specifications, including part orientation and tape sizes, please refer to our Tape and Reel Packaging Specifications Brochure, BRD8011/D.

*NLV Prefix for Automotive and Other Applications Requiring Unique Site and Control Change Requirements; AEC-Q100 Qualified and PPAP Capable

MECHANICAL CASE OUTLINE PACKAGE DIMENSIONS

ON Semiconductor®



SCALE 1:1

SOIC-14 NB
CASE 751A-03
ISSUE L

DATE 03 FEB 2016



- NOTES:
1. DIMENSIONING AND TOLERANCING PER ASME Y14.5M, 1994.
 2. CONTROLLING DIMENSION: MILLIMETERS.
 3. DIMENSION b DOES NOT INCLUDE DAMBAR PROTRUSION. ALLOWABLE PROTRUSION SHALL BE 0.13 TOTAL IN EXCESS OF AT MAXIMUM MATERIAL CONDITION.
 4. DIMENSIONS D AND E DO NOT INCLUDE MOLD PROTRUSIONS.
 5. MAXIMUM MOLD PROTRUSION 0.15 PER SIDE.

| DIM | MILLIMETERS | | INCHES | |
|-----|-------------|------|-----------|-------|
| | MIN | MAX | MIN | MAX |
| A | 1.35 | 1.75 | 0.054 | 0.068 |
| A1 | 0.10 | 0.25 | 0.004 | 0.010 |
| A3 | 0.19 | 0.25 | 0.008 | 0.010 |
| b | 0.35 | 0.49 | 0.014 | 0.019 |
| D | 8.55 | 8.75 | 0.337 | 0.344 |
| E | 3.80 | 4.00 | 0.150 | 0.157 |
| e | 1.27 BSC | | 0.050 BSC | |
| H | 5.80 | 6.20 | 0.228 | 0.244 |
| h | 0.25 | 0.50 | 0.010 | 0.019 |
| L | 0.40 | 1.25 | 0.016 | 0.049 |
| M | 0° | 7° | 0° | 7° |

SOLDERING FOOTPRINT*



DIMENSIONS: MILLIMETERS

*For additional information on our Pb-Free strategy and soldering details, please download the ON Semiconductor Soldering and Mounting Techniques Reference Manual, SOLDERRM/D.

GENERIC MARKING DIAGRAM*



- XXXXXX = Specific Device Code
- A = Assembly Location
- WL = Wafer Lot
- Y = Year
- WW = Work Week
- G = Pb-Free Package

*This information is generic. Please refer to device data sheet for actual part marking. Pb-Free indicator, "G" or microdot "▪", may or may not be present.

STYLES ON PAGE 2

| | | |
|------------------|-------------|--|
| DOCUMENT NUMBER: | 98ASB42565B | Electronic versions are uncontrolled except when accessed directly from the Document Repository. Printed versions are uncontrolled except when stamped "CONTROLLED COPY" in red. |
| DESCRIPTION: | SOIC-14 NB | PAGE 1 OF 2 |

ON Semiconductor and ON are trademarks of Semiconductor Components Industries, LLC dba ON Semiconductor or its subsidiaries in the United States and/or other countries. ON Semiconductor reserves the right to make changes without further notice to any products herein. ON Semiconductor makes no warranty, representation or guarantee regarding the suitability of its products for any particular purpose, nor does ON Semiconductor assume any liability arising out of the application or use of any product or circuit, and specifically disclaims any and all liability, including without limitation special, consequential or incidental damages. ON Semiconductor does not convey any license under its patent rights nor the rights of others.

SOIC-14
CASE 751A-03
ISSUE L

DATE 03 FEB 2016

STYLE 1:
 PIN 1. COMMON CATHODE
 2. ANODE/CATHODE
 3. ANODE/CATHODE
 4. NO CONNECTION
 5. ANODE/CATHODE
 6. NO CONNECTION
 7. ANODE/CATHODE
 8. ANODE/CATHODE
 9. ANODE/CATHODE
 10. NO CONNECTION
 11. ANODE/CATHODE
 12. ANODE/CATHODE
 13. NO CONNECTION
 14. COMMON ANODE

STYLE 2:
 CANCELLED

STYLE 3:
 PIN 1. NO CONNECTION
 2. ANODE
 3. ANODE
 4. NO CONNECTION
 5. ANODE
 6. NO CONNECTION
 7. ANODE
 8. ANODE
 9. ANODE
 10. NO CONNECTION
 11. ANODE
 12. ANODE
 13. NO CONNECTION
 14. COMMON CATHODE

STYLE 4:
 PIN 1. NO CONNECTION
 2. CATHODE
 3. CATHODE
 4. NO CONNECTION
 5. CATHODE
 6. NO CONNECTION
 7. CATHODE
 8. CATHODE
 9. CATHODE
 10. NO CONNECTION
 11. CATHODE
 12. CATHODE
 13. NO CONNECTION
 14. COMMON ANODE

STYLE 5:
 PIN 1. COMMON CATHODE
 2. ANODE/CATHODE
 3. ANODE/CATHODE
 4. ANODE/CATHODE
 5. ANODE/CATHODE
 6. NO CONNECTION
 7. COMMON ANODE
 8. COMMON CATHODE
 9. ANODE/CATHODE
 10. ANODE/CATHODE
 11. ANODE/CATHODE
 12. ANODE/CATHODE
 13. NO CONNECTION
 14. COMMON ANODE

STYLE 6:
 PIN 1. CATHODE
 2. CATHODE
 3. CATHODE
 4. CATHODE
 5. CATHODE
 6. CATHODE
 7. CATHODE
 8. ANODE
 9. ANODE
 10. ANODE
 11. ANODE
 12. ANODE
 13. ANODE
 14. ANODE

STYLE 7:
 PIN 1. ANODE/CATHODE
 2. COMMON ANODE
 3. COMMON CATHODE
 4. ANODE/CATHODE
 5. ANODE/CATHODE
 6. ANODE/CATHODE
 7. ANODE/CATHODE
 8. ANODE/CATHODE
 9. ANODE/CATHODE
 10. ANODE/CATHODE
 11. COMMON CATHODE
 12. COMMON ANODE
 13. ANODE/CATHODE
 14. ANODE/CATHODE

STYLE 8:
 PIN 1. COMMON CATHODE
 2. ANODE/CATHODE
 3. ANODE/CATHODE
 4. NO CONNECTION
 5. ANODE/CATHODE
 6. ANODE/CATHODE
 7. COMMON ANODE
 8. COMMON ANODE
 9. ANODE/CATHODE
 10. ANODE/CATHODE
 11. NO CONNECTION
 12. ANODE/CATHODE
 13. ANODE/CATHODE
 14. COMMON CATHODE

| | | |
|-------------------------|--------------------|---|
| DOCUMENT NUMBER: | 98ASB42565B | Electronic versions are uncontrolled except when accessed directly from the Document Repository. Printed versions are uncontrolled except when stamped "CONTROLLED COPY" in red. |
| DESCRIPTION: | SOIC-14 NB | PAGE 2 OF 2 |

ON Semiconductor and  are trademarks of Semiconductor Components Industries, LLC dba ON Semiconductor or its subsidiaries in the United States and/or other countries. ON Semiconductor reserves the right to make changes without further notice to any products herein. ON Semiconductor makes no warranty, representation or guarantee regarding the suitability of its products for any particular purpose, nor does ON Semiconductor assume any liability arising out of the application or use of any product or circuit, and specifically disclaims any and all liability, including without limitation special, consequential or incidental damages. ON Semiconductor does not convey any license under its patent rights nor the rights of others.

MECHANICAL CASE OUTLINE

PACKAGE DIMENSIONS

ON Semiconductor®



TSSOP-14 WB
CASE 948G
ISSUE C

DATE 17 FEB 2016

SCALE 2:1



NOTES:

- DIMENSIONING AND TOLERANCING PER ANSI Y14.5M, 1982.
- CONTROLLING DIMENSION: MILLIMETER.
- DIMENSION A DOES NOT INCLUDE MOLD FLASH, PROTRUSIONS OR GATE BURRS. MOLD FLASH OR GATE BURRS SHALL NOT EXCEED 0.15 (0.006) PER SIDE.
- DIMENSION B DOES NOT INCLUDE INTERLEAD FLASH OR PROTRUSION. INTERLEAD FLASH OR PROTRUSION SHALL NOT EXCEED 0.25 (0.010) PER SIDE.
- DIMENSION K DOES NOT INCLUDE DAMBAR PROTRUSION. ALLOWABLE DAMBAR PROTRUSION SHALL BE 0.08 (0.003) TOTAL IN EXCESS OF THE K DIMENSION AT MAXIMUM MATERIAL CONDITION.
- TERMINAL NUMBERS ARE SHOWN FOR REFERENCE ONLY.
- DIMENSION A AND B ARE TO BE DETERMINED AT DATUM PLANE -W-.

| DIM | MILLIMETERS | | INCHES | |
|-----|-------------|------|-----------|-------|
| | MIN | MAX | MIN | MAX |
| A | 4.90 | 5.10 | 0.193 | 0.200 |
| B | 4.30 | 4.50 | 0.169 | 0.177 |
| C | --- | 1.20 | --- | 0.047 |
| D | 0.05 | 0.15 | 0.002 | 0.006 |
| F | 0.50 | 0.75 | 0.020 | 0.030 |
| G | 0.65 BSC | | 0.026 BSC | |
| H | 0.50 | 0.60 | 0.020 | 0.024 |
| J | 0.09 | 0.20 | 0.004 | 0.008 |
| J1 | 0.09 | 0.16 | 0.004 | 0.006 |
| K | 0.19 | 0.30 | 0.007 | 0.012 |
| K1 | 0.19 | 0.25 | 0.007 | 0.010 |
| L | 6.40 BSC | | 0.252 BSC | |
| M | 0° | 8° | 0° | 8° |

GENERIC MARKING DIAGRAM*



- A = Assembly Location
- L = Wafer Lot
- Y = Year
- W = Work Week
- = Pb-Free Package

(Note: Microdot may be in either location)

*This information is generic. Please refer to device data sheet for actual part marking. Pb-Free indicator, "G" or microdot "▪", may or may not be present.

SOLDERING FOOTPRINT

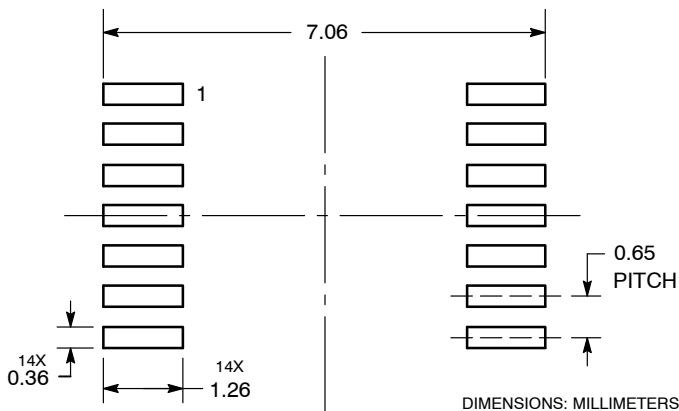

| | | |
|-------------------------|--------------------|--|
| DOCUMENT NUMBER: | 98ASH70246A | Electronic versions are uncontrolled except when accessed directly from the Document Repository. Printed versions are uncontrolled except when stamped "CONTROLLED COPY" in red. |
| DESCRIPTION: | TSSOP-14 WB | PAGE 1 OF 1 |

ON Semiconductor and ON are trademarks of Semiconductor Components Industries, LLC dba ON Semiconductor or its subsidiaries in the United States and/or other countries. ON Semiconductor reserves the right to make changes without further notice to any products herein. ON Semiconductor makes no warranty, representation or guarantee regarding the suitability of its products for any particular purpose, nor does ON Semiconductor assume any liability arising out of the application or use of any product or circuit, and specifically disclaims any and all liability, including without limitation special, consequential or incidental damages. ON Semiconductor does not convey any license under its patent rights nor the rights of others.

onsemi, **Onsemi**, and other names, marks, and brands are registered and/or common law trademarks of Semiconductor Components Industries, LLC dba "**onsemi**" or its affiliates and/or subsidiaries in the United States and/or other countries. **onsemi** owns the rights to a number of patents, trademarks, copyrights, trade secrets, and other intellectual property. A listing of **onsemi**'s product/patent coverage may be accessed at www.onsemi.com/site/pdf/Patent-Marking.pdf. **onsemi** reserves the right to make changes at any time to any products or information herein, without notice. The information herein is provided "as-is" and **onsemi** makes no warranty, representation or guarantee regarding the accuracy of the information, product features, availability, functionality, or suitability of its products for any particular purpose, nor does **onsemi** assume any liability arising out of the application or use of any product or circuit, and specifically disclaims any and all liability, including without limitation special, consequential or incidental damages. Buyer is responsible for its products and applications using **onsemi** products, including compliance with all laws, regulations and safety requirements or standards, regardless of any support or applications information provided by **onsemi**. "Typical" parameters which may be provided in **onsemi** data sheets and/or specifications can and do vary in different applications and actual performance may vary over time. All operating parameters, including "Typicals" must be validated for each customer application by customer's technical experts. **onsemi** does not convey any license under any of its intellectual property rights nor the rights of others. **onsemi** products are not designed, intended, or authorized for use as a critical component in life support systems or any FDA Class 3 medical devices or medical devices with a same or similar classification in a foreign jurisdiction or any devices intended for implantation in the human body. Should Buyer purchase or use **onsemi** products for any such unintended or unauthorized application, Buyer shall indemnify and hold **onsemi** and its officers, employees, subsidiaries, affiliates, and distributors harmless against all claims, costs, damages, and expenses, and reasonable attorney fees arising out of, directly or indirectly, any claim of personal injury or death associated with such unintended or unauthorized use, even if such claim alleges that **onsemi** was negligent regarding the design or manufacture of the part. **onsemi** is an Equal Opportunity/Affirmative Action Employer. This literature is subject to all applicable copyright laws and is not for resale in any manner.

PUBLICATION ORDERING INFORMATION

LITERATURE FULFILLMENT:

Email Requests to: orderlit@onsemi.com

onsemi Website: www.onsemi.com

TECHNICAL SUPPORT

North American Technical Support:

Voice Mail: 1 800-282-9855 Toll Free USA/Canada

Phone: 011 421 33 790 2910

Europe, Middle East and Africa Technical Support:

Phone: 00421 33 790 2910

For additional information, please contact your local Sales Representative