

MJ11015 (PNP); MJ11012, MJ11016 (NPN)

MJ11016 is a Preferred Device

High-Current Complementary Silicon Transistors

... for use as output devices in complementary general purpose amplifier applications.

- High DC Current Gain –
 $h_{FE} = 1000$ (Min) @ $I_C = 20$ Adc
- Monolithic Construction with Built-in Base Emitter Shunt Resistor
- Junction Temperature to $+200^\circ\text{C}$

MAXIMUM RATINGS

Rating	Symbol	Value	Unit
Collector-Emitter Voltage MJ11012 MJ11015/6	V_{CEO}	60 120	Vdc
Collector-Base Voltage MJ11012 MJ11015/6	V_{CB}	60 120	Vdc
Emitter-Base Voltage	V_{EB}	5	Vdc
Collector Current	I_C	30	Adc
Base Current	I_B	1	Adc
Total Device Dissipation @ $T_C = 25^\circ\text{C}$ Derate above 25°C @ $T_C = 100^\circ\text{C}$	P_D	200 1.15	W W/ $^\circ\text{C}$
Operating Storage Junction Temperature Range	T_J, T_{stg}	-55 to +200	$^\circ\text{C}$

THERMAL CHARACTERISTICS

Characteristic	Symbol	Max	Unit
Thermal Resistance, Junction-to-Case	$R_{\theta JC}$	0.87	$^\circ\text{C}/\text{W}$
Maximum Lead Temperature for Soldering Purposes for ≤ 10 Seconds	T_L	275	$^\circ\text{C}$

Stresses exceeding Maximum Ratings may damage the device. Maximum Ratings are stress ratings only. Functional operation above the Recommended Operating Conditions is not implied. Extended exposure to stresses above the Recommended Operating Conditions may affect device reliability.



ON Semiconductor®

<http://onsemi.com>

30 AMPERE DARLINGTON POWER TRANSISTORS COMPLEMENTARY SILICON 60 – 120 VOLTS, 200 WATTS

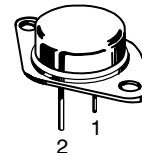

TO-204AA (TO-3)
CASE 1-07
STYLE 1

MARKING DIAGRAM



- MJ1101x = Device Code
x = 2, 5 or 6
- G = Pb-Free Package
- A = Location Code
- YY = Year
- WW = Work Week
- MEX = Country of Origin

ORDERING INFORMATION

Device	Package	Shipping
MJ11012	TO-3	100 Units/Tray
MJ11012G	TO-3 (Pb-Free)	100 Units/Tray
MJ11015	TO-3	100 Units/Tray
MJ11015G	TO-3 (Pb-Free)	100 Units/Tray
MJ11016	TO-3	100 Units/Tray
MJ11016G	TO-3 (Pb-Free)	100 Units/Tray

Preferred devices are recommended choices for future use and best overall value.

MJ11015 (PNP); MJ11012, MJ11016 (NPN)



Figure 1. Darlington Circuit Schematic

ELECTRICAL CHARACTERISTICS ($T_C = 25^\circ\text{C}$ unless otherwise noted.)

Characteristics	Symbol	Min	Max	Unit
OFF CHARACTERISTICS				
Collector–Emitter Breakdown Voltage(1) ($I_C = 100\text{ mAdc}$, $I_B = 0$)	$V_{(BR)CEO}$	60 120	– –	Vdc
Collector–Emitter Leakage Current ($V_{CE} = 60\text{ Vdc}$, $R_{BE} = 1\text{ k ohm}$) ($V_{CE} = 120\text{ Vdc}$, $R_{BE} = 1\text{ k ohm}$) ($V_{CE} = 60\text{ Vdc}$, $R_{BE} = 1\text{ k ohm}$, $T_C = 150^\circ\text{C}$) ($V_{CE} = 120\text{ Vdc}$, $R_{BE} = 1\text{ k ohm}$, $T_C = 150^\circ\text{C}$)	I_{CER}	– – – –	1 1 5 5	mAdc
Emitter Cutoff Current ($V_{BE} = 5\text{ Vdc}$, $I_C = 0$)	I_{EBO}	–	5	mAdc
Collector–Emitter Leakage Current ($V_{CE} = 50\text{ Vdc}$, $I_B = 0$)	I_{CEO}	–	1	mAdc
ON CHARACTERISTICS(1)				
DC Current Gain ($I_C = 20\text{ Adc}$, $V_{CE} = 5\text{ Vdc}$) ($I_C = 30\text{ Adc}$, $V_{CE} = 5\text{ Vdc}$)	h_{FE}	1000 200	– –	–
Collector–Emitter Saturation Voltage ($I_C = 20\text{ Adc}$, $I_B = 200\text{ mAdc}$) ($I_C = 30\text{ Adc}$, $I_B = 300\text{ mAdc}$)	$V_{CE(sat)}$	– –	3 4	Vdc
Base–Emitter Saturation Voltage ($I_C = 20\text{ A}$, $I_B = 200\text{ mAdc}$) ($I_C = 30\text{ A}$, $I_B = 300\text{ mAdc}$)	$V_{BE(sat)}$	– –	3.5 5	Vdc
DYNAMIC CHARACTERISTICS				
Current–Gain Bandwidth Product ($I_C = 10\text{ A}$, $V_{CE} = 3\text{ Vdc}$, $f = 1\text{ MHz}$)	h_{fe}	4	–	MHz

(1) Pulse Test: Pulse Width = 300 μs , Duty Cycle $\leq 2.0\%$.

MJ11015 (PNP); MJ11012, MJ11016 (NPN)

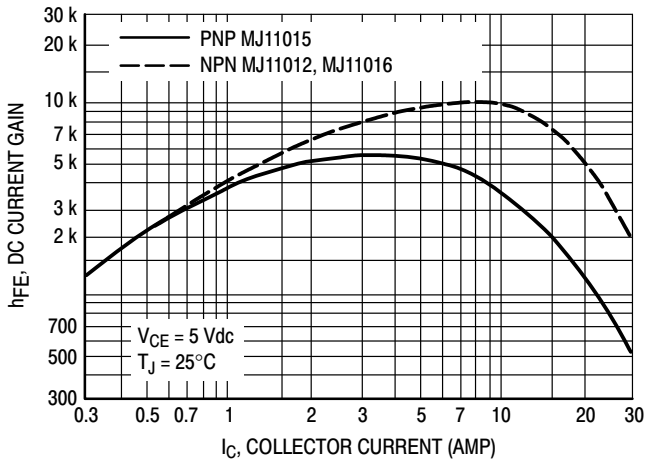

Figure 2. DC Current Gain (1)

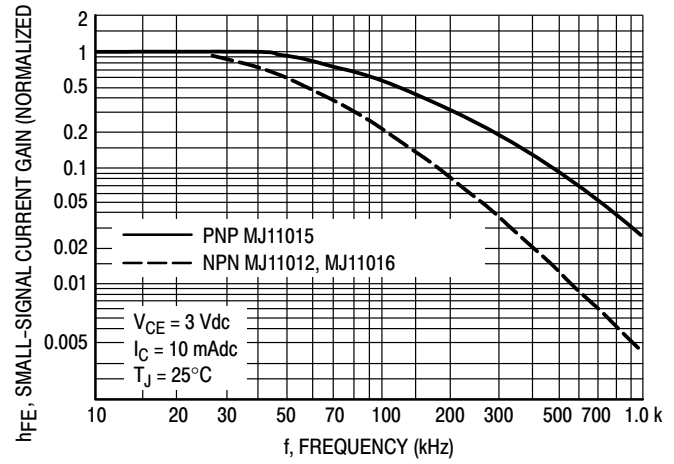

Figure 3. Small-Signal Current Gain

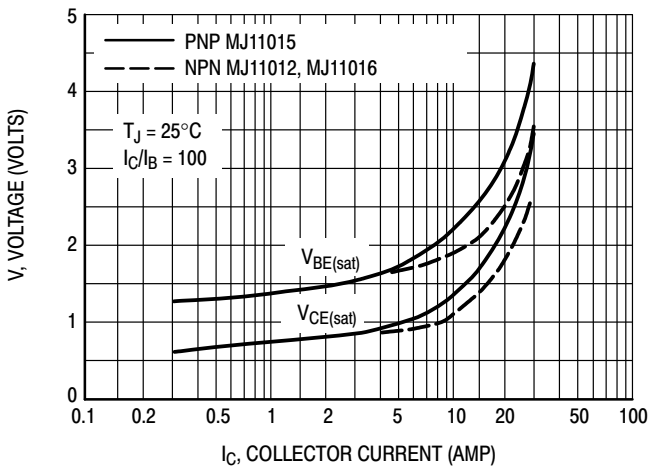

Figure 4. "On" Voltages (1)

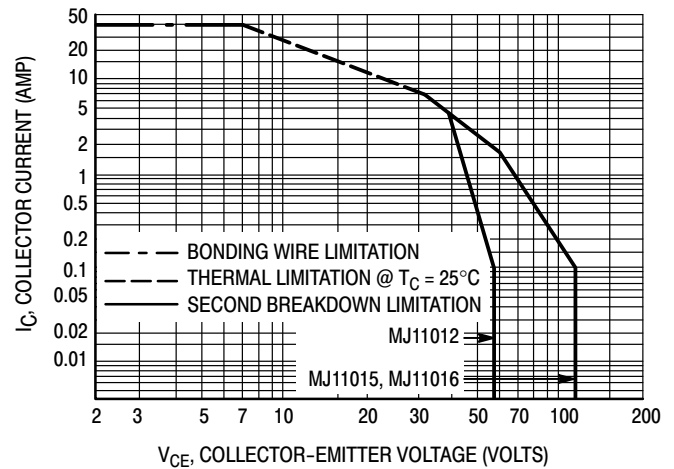

Figure 5. Active Region DC Safe Operating Area

There are two limitations on the power handling ability of a transistor average junction temperature and secondary breakdown. Safe operating area curves indicate $I_C - V_{CE}$ limits of the transistor that must be observed for reliable operations e.g., the transistor must not be subjected to greater dissipation than the curves indicate.

At high case temperatures, thermal limitations will reduce the power that can be handled to values less than the limitations imposed by secondary breakdown.

MECHANICAL CASE OUTLINE PACKAGE DIMENSIONS

ON Semiconductor

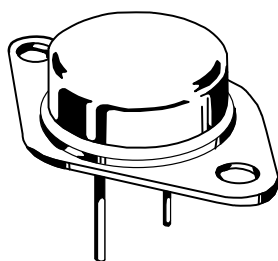

TO-204 (TO-3)
CASE 1-07
ISSUE Z

DATE 05/18/1988

SCALE 1:1

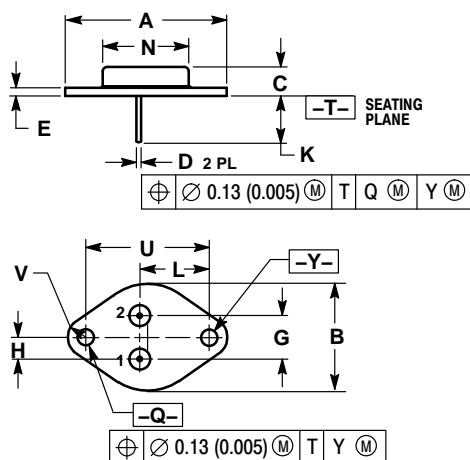

- NOTES:
1. DIMENSIONING AND TOLERANCING PER ANSI Y14.5M, 1982.
 2. CONTROLLING DIMENSION: INCH.
 3. ALL RULES AND NOTES ASSOCIATED WITH REFERENCED TO-204AA OUTLINE SHALL APPLY.

DIM	INCHES		MILLIMETERS	
	MIN	MAX	MIN	MAX
A	1.550 REF	---	39.37 REF	---
B	---	1.050	---	26.67
C	0.250	0.335	6.35	8.51
D	0.038	0.043	0.97	1.09
E	0.055	0.070	1.40	1.77
G	0.430 BSC	---	10.92 BSC	---
H	0.215 BSC	---	5.46 BSC	---
K	0.440	0.480	11.18	12.19
L	---	0.665 BSC	---	16.89 BSC
N	---	0.830	---	21.08
Q	0.151	0.165	3.84	4.19
U	1.187 BSC	---	30.15 BSC	---
V	0.131	0.188	3.33	4.77

- | | | | | |
|--|--|---|---|---|
| <p>STYLE 1:
PIN 1. BASE
2. EMITTER
CASE: COLLECTOR</p> | <p>STYLE 2:
PIN 1. BASE
2. COLLECTOR
CASE: EMITTER</p> | <p>STYLE 3:
PIN 1. GATE
2. SOURCE
CASE: DRAIN</p> | <p>STYLE 4:
PIN 1. GROUND
2. INPUT
CASE: OUTPUT</p> | <p>STYLE 5:
PIN 1. CATHODE
2. EXTERNAL TRIP/DELAY
CASE: ANODE</p> |
| <p>STYLE 6:
PIN 1. GATE
2. EMITTER
CASE: COLLECTOR</p> | <p>STYLE 7:
PIN 1. ANODE
2. OPEN
CASE: CATHODE</p> | <p>STYLE 8:
PIN 1. CATHODE #1
2. CATHODE #2
CASE: ANODE</p> | <p>STYLE 9:
PIN 1. ANODE #1
2. ANODE #2
CASE: CATHODE</p> | |

ON Semiconductor and are trademarks of Semiconductor Components Industries, LLC (SCILLC). SCILLC reserves the right to make changes without further notice to any products herein. SCILLC makes no warranty, representation or guarantee regarding the suitability of its products for any particular purpose, nor does SCILLC assume any liability arising out of the application or use of any product or circuit, and specifically disclaims any and all liability, including without limitation special, consequential or incidental damages. "Typical" parameters which may be provided in SCILLC data sheets and/or specifications can and do vary in different applications and actual performance may vary over time. All operating parameters, including "Typicals" must be validated for each customer application by customer's technical experts. SCILLC does not convey any license under its patent rights nor the rights of others. SCILLC products are not designed, intended, or authorized for use as components in systems intended for surgical implant into the body, or other applications intended to support or sustain life, or for any other application in which the failure of the SCILLC product could create a situation where personal injury or death may occur. Should Buyer purchase or use SCILLC products for any such unintended or unauthorized application, Buyer shall indemnify and hold SCILLC and its officers, employees, subsidiaries, affiliates, and distributors harmless against all claims, costs, damages, and expenses, and reasonable attorney fees arising out of, directly or indirectly, any claim of personal injury or death associated with such unintended or unauthorized use, even if such claim alleges that SCILLC was negligent regarding the design or manufacture of the part. SCILLC is an Equal Opportunity/Affirmative Action Employer.

onsemi, **Onsemi**, and other names, marks, and brands are registered and/or common law trademarks of Semiconductor Components Industries, LLC dba "**onsemi**" or its affiliates and/or subsidiaries in the United States and/or other countries. **onsemi** owns the rights to a number of patents, trademarks, copyrights, trade secrets, and other intellectual property. A listing of **onsemi**'s product/patent coverage may be accessed at www.onsemi.com/site/pdf/Patent-Marking.pdf. **onsemi** reserves the right to make changes at any time to any products or information herein, without notice. The information herein is provided "as-is" and **onsemi** makes no warranty, representation or guarantee regarding the accuracy of the information, product features, availability, functionality, or suitability of its products for any particular purpose, nor does **onsemi** assume any liability arising out of the application or use of any product or circuit, and specifically disclaims any and all liability, including without limitation special, consequential or incidental damages. Buyer is responsible for its products and applications using **onsemi** products, including compliance with all laws, regulations and safety requirements or standards, regardless of any support or applications information provided by **onsemi**. "Typical" parameters which may be provided in **onsemi** data sheets and/or specifications can and do vary in different applications and actual performance may vary over time. All operating parameters, including "Typicals" must be validated for each customer application by customer's technical experts. **onsemi** does not convey any license under any of its intellectual property rights nor the rights of others. **onsemi** products are not designed, intended, or authorized for use as a critical component in life support systems or any FDA Class 3 medical devices or medical devices with a same or similar classification in a foreign jurisdiction or any devices intended for implantation in the human body. Should Buyer purchase or use **onsemi** products for any such unintended or unauthorized application, Buyer shall indemnify and hold **onsemi** and its officers, employees, subsidiaries, affiliates, and distributors harmless against all claims, costs, damages, and expenses, and reasonable attorney fees arising out of, directly or indirectly, any claim of personal injury or death associated with such unintended or unauthorized use, even if such claim alleges that **onsemi** was negligent regarding the design or manufacture of the part. **onsemi** is an Equal Opportunity/Affirmative Action Employer. This literature is subject to all applicable copyright laws and is not for resale in any manner.

PUBLICATION ORDERING INFORMATION

LITERATURE FULFILLMENT:

Email Requests to: orderlit@onsemi.com

onsemi Website: www.onsemi.com

TECHNICAL SUPPORT

North American Technical Support:

Voice Mail: 1 800-282-9855 Toll Free USA/Canada

Phone: 011 421 33 790 2910

Europe, Middle East and Africa Technical Support:

Phone: 00421 33 790 2910

For additional information, please contact your local Sales Representative