

Integrated Load Switch

FDC6324L



TSOT-23-6
CASE 419BL

Description

These Integrated Load Switches are produced using onsemi's proprietary, high cell density, DMOS technology. This very high density process is especially tailored to minimize on-state resistance and provide superior switching performance. These devices are particularly suited for low voltage high side load switch application where low conduction loss and ease of driving are needed.

Features

- $V_{DROP} = 0.2\text{ V @ } V_{IN} = 12\text{ V, } I_L = 1\text{ A, } V_{ON/OFF} = 1.5\text{ to }8\text{ V}$
- $V_{DROP} = 0.3\text{ V @ } V_{IN} = 5\text{ V, } I_L = 1\text{ A, } V_{ON/OFF} = 1.5\text{ to }8\text{ V}$
- High Density Cell Design for Extremely Low On-Resistance
- $V_{ON/OFF}$ Zener Protection for ESD Ruggedness > 6 kV Human Body Model
- SUPERSOT™ -6 Package Design Using Copper Lead Frame for Superior Thermal and Electrical Capabilities
- This is a Pb-Free and Halide Free Device

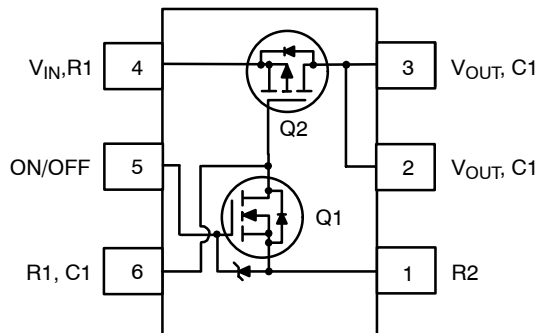

Figure 1.

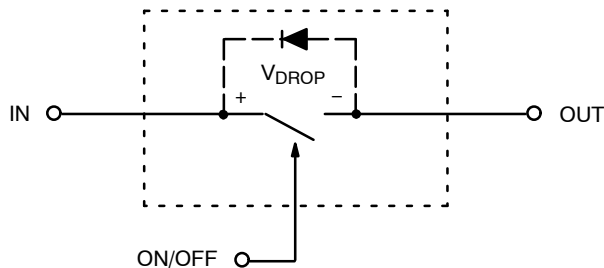
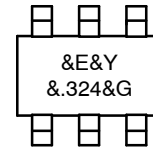

Figure 2. Equivalent Circuit

MARKING DIAGRAM



- &E = Designates Space
- &Y = Binary Calendar Year Coding Scheme
- &. = Pin One Dot
- 324 = Specific Device Code
- &G = Date Code

ORDERING INFORMATION

Device	Package	Shipping†
FDC6324L	TSOT-23-6 (Pb-Free)	3000 / Tape & Reel

†For information on tape and reel specifications, including part orientation and tape sizes, please refer to our Tape and Reel Packaging Specification Brochure, BRD8011/D.

FDC6324L

ABSOLUTE MAXIMUM RATINGS $T_A = 25^\circ\text{C}$ unless otherwise noted

Symbol	Parameter	Value	Unit
V_{IN}	Input Voltage Range	3–20	V
$V_{ON/OFF}$	On/Off Voltage Range	1.5–8	V
I_L	Load Current @ $V_{DROP} = 0.5\text{ V}$ – Continuous (Note 1)	1.5	A
	Load Current @ $V_{DROP} = 0.5\text{ V}$ – Pulsed (Note 1, Note 3)	2.5	
P_D	Maximum Power Dissipation (Note 2a)	0.7	W
T_J, T_{STG}	Operating and Storage Temperature Range	–55 to 150	$^\circ\text{C}$
ESD	Electrostatic Discharge Rating MIL–STD–883D Human Body Model (100 pF/1500 Ω)	6	kV

Stresses exceeding those listed in the Maximum Ratings table may damage the device. If any of these limits are exceeded, device functionality should not be assumed, damage may occur and reliability may be affected.

THERMAL CHARACTERISTICS $T_A = 25^\circ\text{C}$ unless otherwise noted

Symbol	Parameter	Value	Unit
$R_{\theta JA}$	Thermal Resistance, Junction–to–Ambient (Note 2a)	180	$^\circ\text{C}/\text{W}$
$R_{\theta JC}$	Thermal Resistance, Junction–to–Case (Note 2)	60	$^\circ\text{C}/\text{W}$

ELECTRICAL CHARACTERISTICS $T_A = 25^\circ\text{C}$ unless otherwise noted

Symbol	Parameter	Test Conditions	Min	Typ	Max	Unit
--------	-----------	-----------------	-----	-----	-----	------

OFF CHARACTERISTICS

I_{FL}	Forward Leakage Current	$V_{IN} = 20\text{ V}, V_{ON/OFF} = 0\text{ V}$	–	–	1	μA
I_{RL}	Reverse Leakage Current	$V_{IN} = -20\text{ V}, V_{ON/OFF} = 0\text{ V}$	–	–	–1	μA

ON CHARACTERISTICS (Note 3)

V_{IN}	Input Voltage		3	–	20	V
$V_{ON/OFF}$	On/Off Voltage		1.5	–	8	V
V_{DROP}	Conduction Voltage Drop @ 1 A	$V_{IN} = 10\text{ V}, V_{ON/OFF} = 3.3\text{ V}$	–	0.135	0.2	V
		$V_{IN} = 5\text{ V}, V_{ON/OFF} = 3.3\text{ V}$	–	0.215	0.3	
I_L	Load Current	$V_{DROP} = 0.2\text{ V}, V_{IN} = 10\text{ V}, V_{ON/OFF} = 3.3\text{ V}$	1	–	–	A
		$V_{DROP} = 0.3\text{ V}, V_{IN} = 5\text{ V}, V_{ON/OFF} = 3.3\text{ V}$	1	–	–	

Product parametric performance is indicated in the Electrical Characteristics for the listed test conditions, unless otherwise noted. Product performance may not be indicated by the Electrical Characteristics if operated under different conditions.

NOTES:

- $V_{IN} = 20\text{ V}, V_{ON/OFF} = 8\text{ V}, V_{DROP} = 0.5\text{ V}, T_A = 25^\circ\text{C}$
- $R_{\theta JA}$ is the sum of the junction–to–case and case–to–ambient thermal resistance where the case thermal reference is defined as the solder mounting surface of the drain pins. $R_{\theta JC}$ is guaranteed by design while $R_{\theta CA}$ is determined by the user's board design.

$$P_D(t) = \frac{T_J - T_A}{R_{\theta JA}(t)} = \frac{T_J - T_A}{R_{\theta JC} + R_{\theta CA}(t)} = I_D^2(t) \times R_{DS(ON)}@T_J$$

Typical $R_{\theta CA}$ for single device operation using the board layouts shown below on FR–4 PCB in a still air environment:

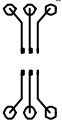

- a) 180 $^\circ\text{C}/\text{W}$ when mounted on a 2oz minimum copper pad.

- Pulse Test: Pulse Width $\leq 300\ \mu\text{s}$, Duty Cycle $\leq 2.0\%$.

TYPICAL ELECTRICAL CHARACTERISTICS ($T_A = 25^\circ\text{C}$ unless otherwise noted)

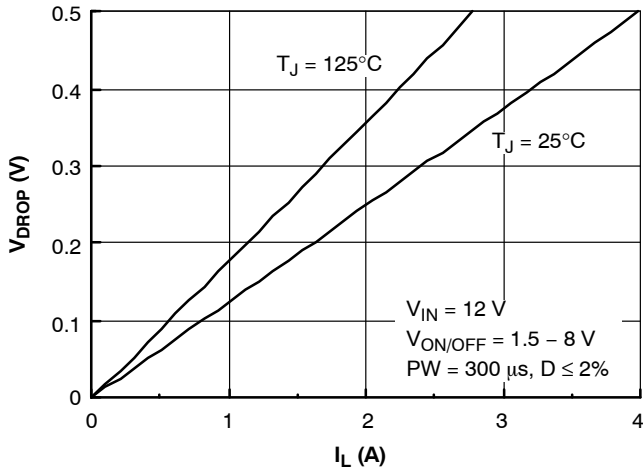

Figure 3. V_{DROP} Versus I_L at $V_{\text{IN}} = 12 \text{ V}$

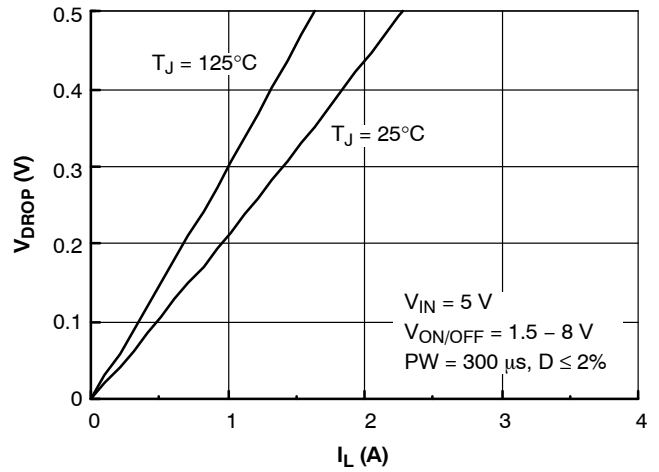

Figure 4. V_{DROP} Versus I_L at $V_{\text{IN}} = 5.0 \text{ V}$

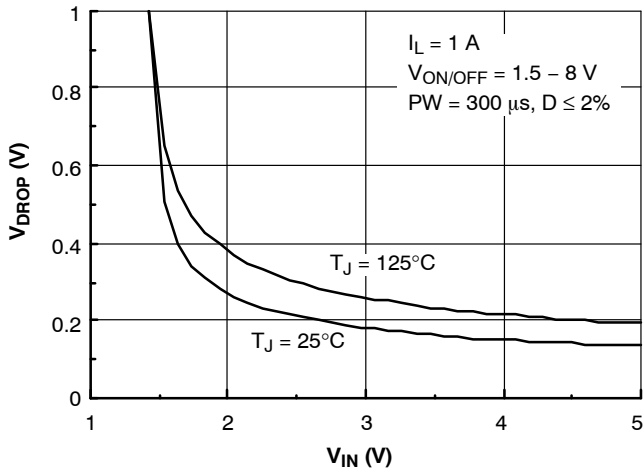

Figure 5. V_{DROP} Versus V_{IN} at $I_L = 1 \text{ A}$

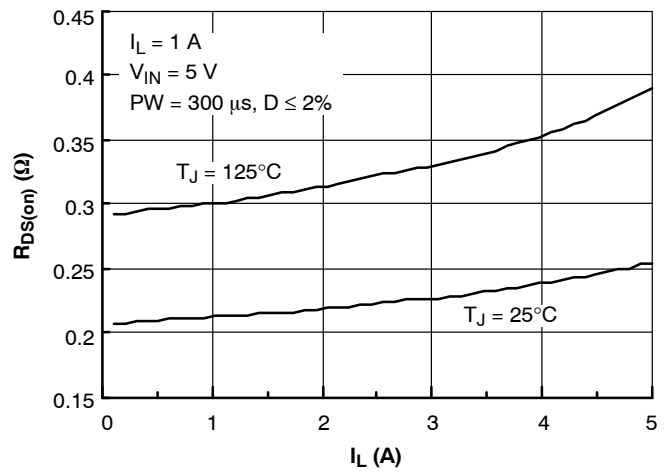

Figure 6. $R_{\text{DS(on)}}$ Versus I_L at $V_{\text{IN}} = 5.0 \text{ V}$

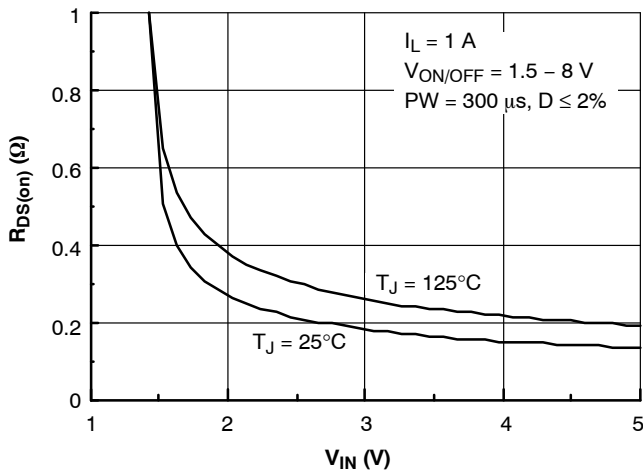

Figure 7. On Resistance Variation with Input Voltage

TYPICAL ELECTRICAL CHARACTERISTICS ($T_A = 25^\circ\text{C}$ unless otherwise noted)

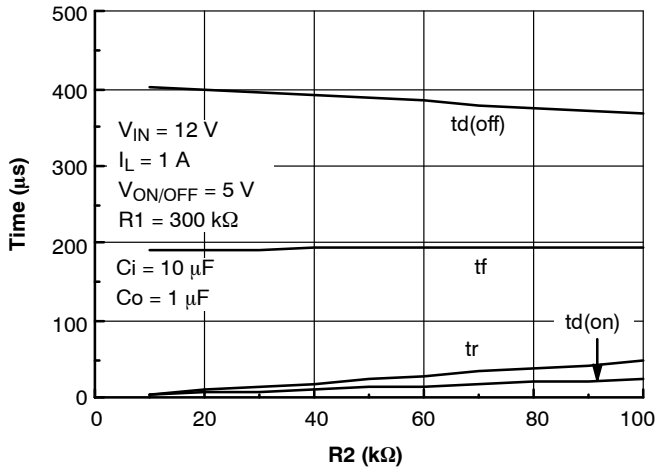

Figure 8. Switching Variation with R_2 at $V_{IN} = 12\text{ V}$ and $R_1 = 300\text{ k}\Omega$

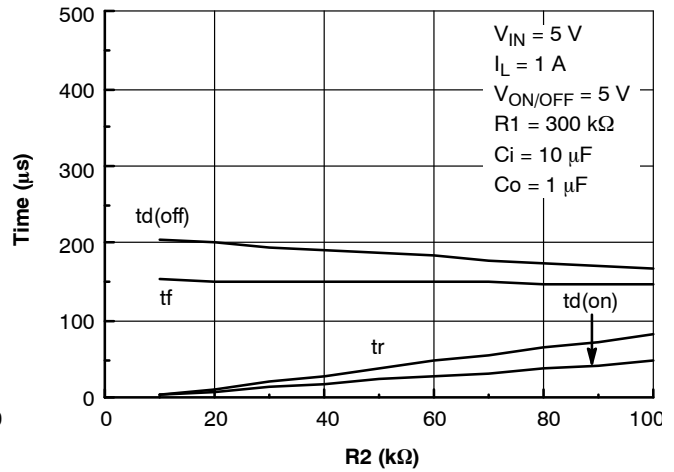

Figure 9. Switching Variation with R_2 at $V_{IN} = 5\text{ V}$ and $R_1 = 300\text{ k}\Omega$

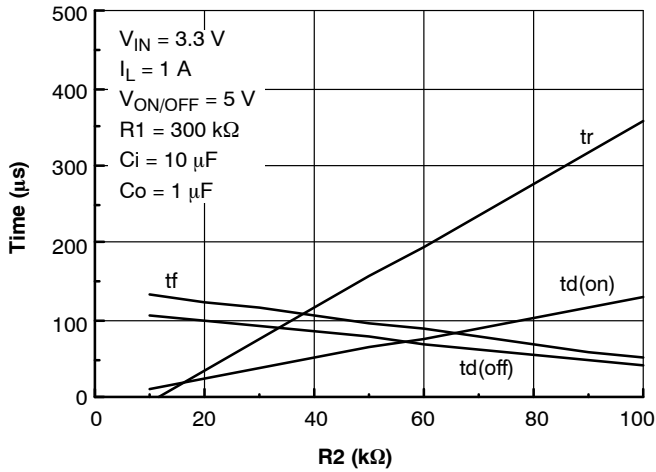

Figure 10. Switching Variation with R_2 at $V_{IN} = 3.3\text{ V}$ and $R_1 = 300\text{ k}\Omega$

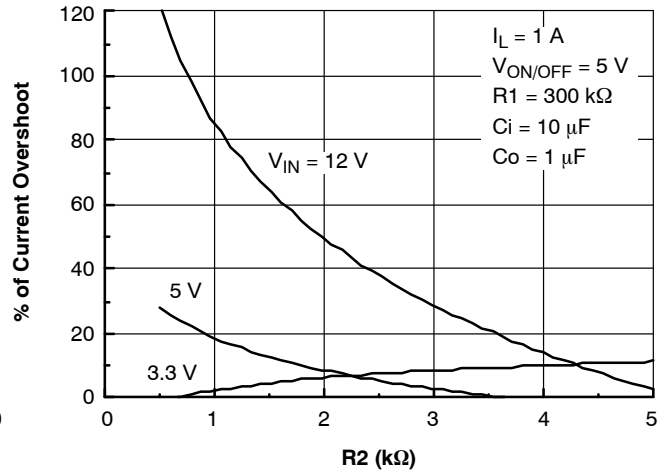

Figure 11. % of Current Overshoot Variation with V_{IN} and R_2

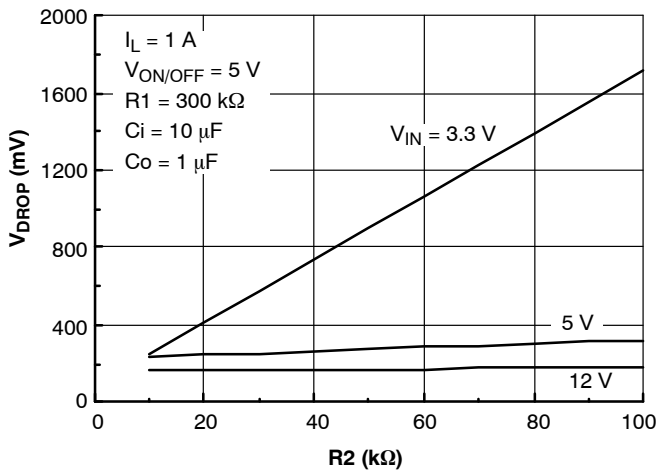

Figure 12. V_{DROP} Variation with V_{IN} and R_2

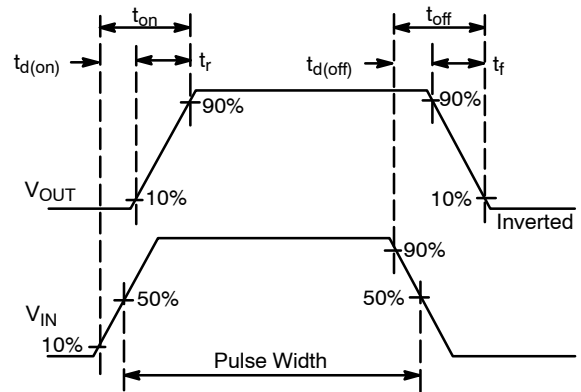

Figure 13. Switching Waveforms

FDC6324L

TYPICAL ELECTRICAL CHARACTERISTICS ($T_A = 25^\circ\text{C}$ unless otherwise noted)

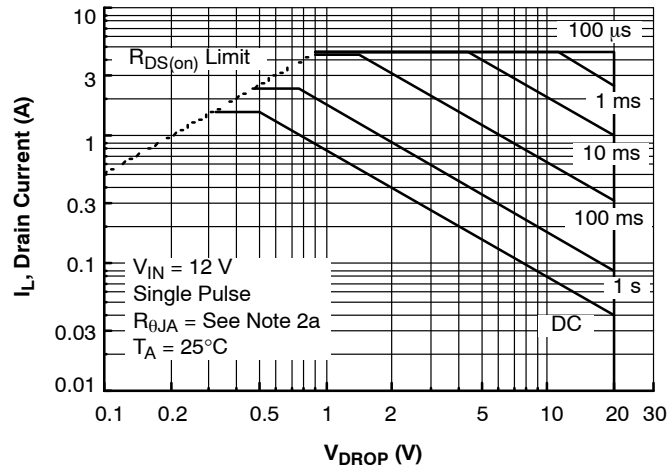

Figure 14. Safe Operating Area

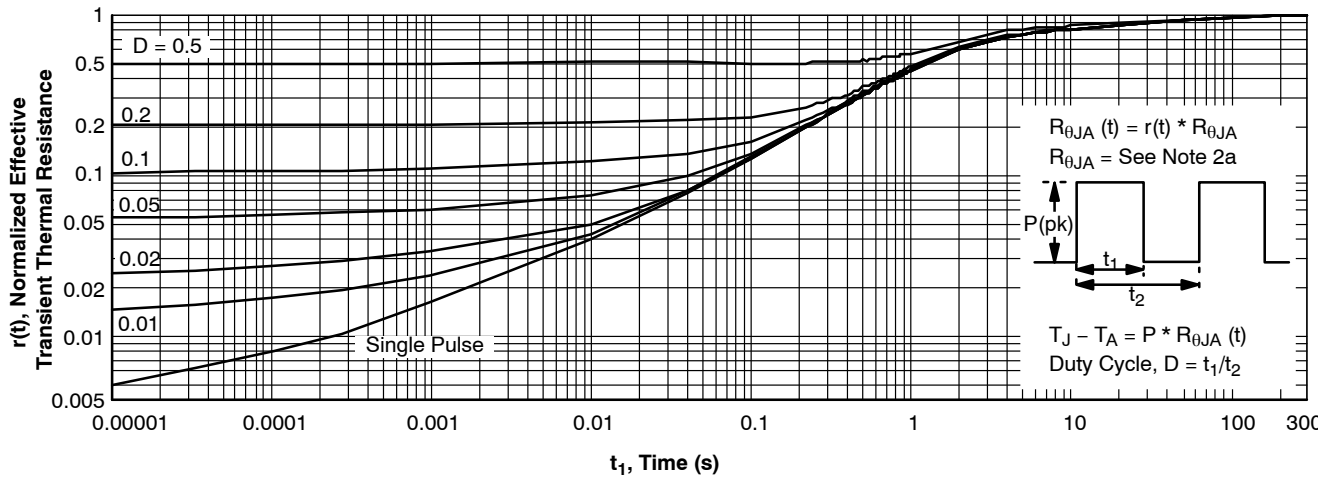

Figure 15. Transient Thermal Response Curve

NOTE: Thermal characterization performed on the conditions described in Note 2a. Transient thermal response will change depends on the circuit board.

LOAD SWITCH APPLICATION

General Description

This device is particularly suited for computer peripheral switching applications where 20 V input and 1 A output current capability are needed. This load switch integrates a small N-Channel Power MOSFET (Q1) which drives a large P-Channel Power MOSFET (Q2) in one tiny SUPERSOT-6 package.

A load switch is usually configured for high side switching so that the load can be isolated from the active power source. A P-Channel Power MOSFET, because it does not require its drive voltage above the input voltage, is usually more cost effective than using an N-Channel device in this particular application. A large P-Channel Power MOSFET minimizes voltage drop. By using a small N-Channel device the driving stage is simplified.

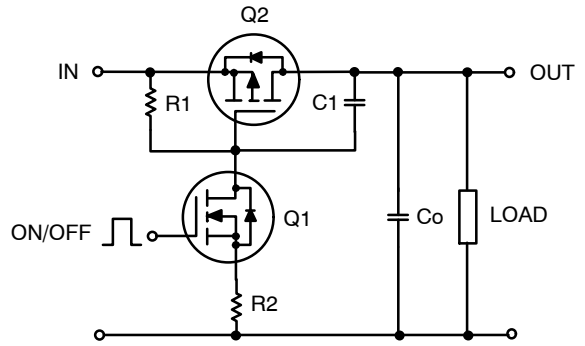

Figure 16. Application Circuit

Component Values

- R1: Typical 10k-1 MΩ
- R2: Typical 0-100 kΩ (optional)
- C1: Typical 1000 pF (optional)

Design Notes

- R1 is needed to turn off Q2.
- R2 can be used to soft start the switch in case the output capacitance Co is small.
- R2 should be at least 10 times smaller than R1 to guarantee Q1 turns on.
- By using R1 and R2 a certain amount of current is lost from the input. This bias current loss is given by the equation:

$$I_{BIAS_LOSS} = \frac{V_{IN}}{R1 + R2}$$
 when the switch is ON. I_{BIAS_LOSS} can be minimized by selecting a large value for R1.
- R2 and C_{RSS} of Q2 make ramp for slow turn on. If excessive overshoot current occurs due to fast turn on, additional capacitance C1 can be added externally to slow down the turn on.

SUPERSOT is a trademark of Semiconductor Components Industries, LLC dba "onsemi" or its affiliates and/or subsidiaries in the United States and/or other countries.

MECHANICAL CASE OUTLINE

PACKAGE DIMENSIONS

ON Semiconductor®



1
SCALE 2:1

TSOT23 6-Lead CASE 419BL ISSUE A

DATE 31 AUG 2020

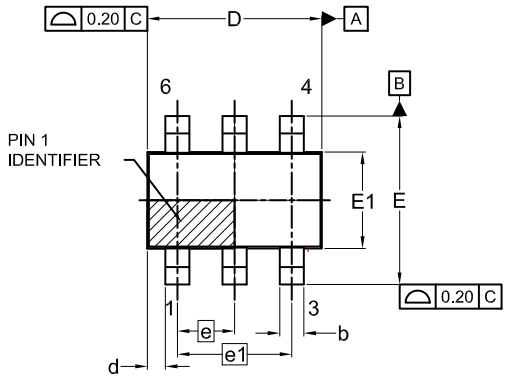

TOP VIEW

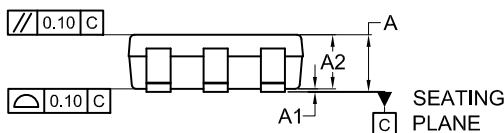

FRONT VIEW



DETAIL A

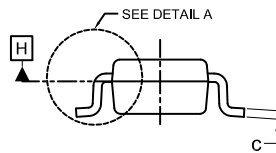

SIDE VIEW

SYMM
⌀

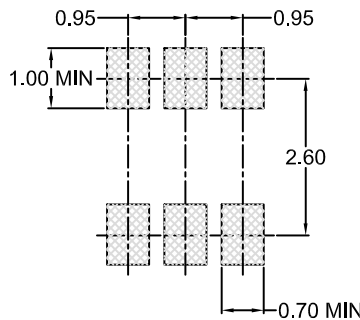

LAND PATTERN
RECOMMENDATION

*FOR ADDITIONAL INFORMATION ON OUR
Pb-FREE STRATEGY AND SOLDERING DETAILS,
PLEASE DOWNLOAD THE ON SEMICONDUCTOR
SOLDERING AND MOUNTING TECHNIQUES
REFERENCE MANUAL, SOLDERRM/D.

NOTES:

1. DIMENSIONING AND TOLERANCING PER ASME Y14.5M, 2009.
2. CONTROLLING DIMENSION: MILLIMETERS
3. DIMENSIONS D AND E1 DO NOT INCLUDE MOLD FLASH, PROTRUSIONS, OR GATE BURRS. MOLD FLASH, PROTRUSIONS OR GATE BURRS SHALL NOT EXCEED 0.25MM PER END. DIMENSIONS D AND E1 ARE DETERMINED AT DATUM H.
4. SEATING PLANE IS DEFINED BY THE TERMINALS. "A1" IS DEFINED AS THE DISTANCE FROM THE SEATING PLANE TO THE LOWEST POINT ON THE PACKAGE BODY.

DIM	MILLIMETERS		
	MIN.	NOM.	MAX.
A	0.90	1.00	1.10
A1	0.00	0.05	0.10
A2	0.70	0.85	1.00
A3	0.25 BSC		
b	0.25	0.38	0.50
c	0.10	0.18	0.26
D	2.80	2.95	3.10
d	0.30 REF		
E	2.50	2.75	3.00
E1	1.30	1.50	1.70
e	0.95 BSC		
e1	1.90 BSC		
L1	0.60 REF		
L2	0.20	0.40	0.60
⌀	0°	--	10°

GENERIC MARKING DIAGRAM*

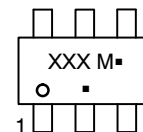

XXX = Specific Device Code
M = Date Code
▪ = Pb-Free Package

(Note: Microdot may be in either location)

*This information is generic. Please refer to device data sheet for actual part marking. Pb-Free indicator, "G" or microdot "▪", may or may not be present. Some products may not follow the Generic Marking.

DOCUMENT NUMBER:	98AON83292G	Electronic versions are uncontrolled except when accessed directly from the Document Repository. Printed versions are uncontrolled except when stamped "CONTROLLED COPY" in red.
DESCRIPTION:	TSOT23 6-Lead	PAGE 1 OF 1

ON Semiconductor and ON are trademarks of Semiconductor Components Industries, LLC dba ON Semiconductor or its subsidiaries in the United States and/or other countries. ON Semiconductor reserves the right to make changes without further notice to any products herein. ON Semiconductor makes no warranty, representation or guarantee regarding the suitability of its products for any particular purpose, nor does ON Semiconductor assume any liability arising out of the application or use of any product or circuit, and specifically disclaims any and all liability, including without limitation special, consequential or incidental damages. ON Semiconductor does not convey any license under its patent rights nor the rights of others.

onsemi, **Onsemi**, and other names, marks, and brands are registered and/or common law trademarks of Semiconductor Components Industries, LLC dba "**onsemi**" or its affiliates and/or subsidiaries in the United States and/or other countries. **onsemi** owns the rights to a number of patents, trademarks, copyrights, trade secrets, and other intellectual property. A listing of **onsemi**'s product/patent coverage may be accessed at www.onsemi.com/site/pdf/Patent-Marking.pdf. **onsemi** reserves the right to make changes at any time to any products or information herein, without notice. The information herein is provided "as-is" and **onsemi** makes no warranty, representation or guarantee regarding the accuracy of the information, product features, availability, functionality, or suitability of its products for any particular purpose, nor does **onsemi** assume any liability arising out of the application or use of any product or circuit, and specifically disclaims any and all liability, including without limitation special, consequential or incidental damages. Buyer is responsible for its products and applications using **onsemi** products, including compliance with all laws, regulations and safety requirements or standards, regardless of any support or applications information provided by **onsemi**. "Typical" parameters which may be provided in **onsemi** data sheets and/or specifications can and do vary in different applications and actual performance may vary over time. All operating parameters, including "Typicals" must be validated for each customer application by customer's technical experts. **onsemi** does not convey any license under any of its intellectual property rights nor the rights of others. **onsemi** products are not designed, intended, or authorized for use as a critical component in life support systems or any FDA Class 3 medical devices or medical devices with a same or similar classification in a foreign jurisdiction or any devices intended for implantation in the human body. Should Buyer purchase or use **onsemi** products for any such unintended or unauthorized application, Buyer shall indemnify and hold **onsemi** and its officers, employees, subsidiaries, affiliates, and distributors harmless against all claims, costs, damages, and expenses, and reasonable attorney fees arising out of, directly or indirectly, any claim of personal injury or death associated with such unintended or unauthorized use, even if such claim alleges that **onsemi** was negligent regarding the design or manufacture of the part. **onsemi** is an Equal Opportunity/Affirmative Action Employer. This literature is subject to all applicable copyright laws and is not for resale in any manner.

PUBLICATION ORDERING INFORMATION

LITERATURE FULFILLMENT:

Email Requests to: orderlit@onsemi.com

onsemi Website: www.onsemi.com

TECHNICAL SUPPORT

North American Technical Support:

Voice Mail: 1 800-282-9855 Toll Free USA/Canada

Phone: 011 421 33 790 2910

Europe, Middle East and Africa Technical Support:

Phone: 00421 33 790 2910

For additional information, please contact your local Sales Representative