

## Ultra Low Power, 14V, 200mA LDO Regulator

### General Description

The RT9067 is a low-dropout (LDO) voltage regulator with enable function offering benefits of up to 14V input voltage, low-dropout, low-power operation, and miniaturized packaging.

The features of low quiescent current as low as 2μA and zero disable current is ideal for powering the battery equipment to a longer service life. The RT9067 is stable with ceramic output capacitors over its wide input range from 3.5V to 14V and entire range of output load current (0mA to 200mA).

### Applications

- Portable, Battery Powered Equipments
- Ultra Low Voltage Microcontrollers
- Notebook Computers

### Marking Information

For marking information, contact our sales representative directly or through a Richtek distributor located in your area.

### Features

- 2μA Ground Current at no Load
- ±2% Output Accuracy
- 200mA Output Current with EN
- Zero Disable Current
- Maximum Operating Input Voltage 14V
- Dropout Voltage : 0.4V at 100mA
- Support Fixed Output Voltage 2.5V, 3V, 3.3V, 3.6V, 4.2V, 5V, 9V (3V, 3.6V for SOT-23-5 package only)
- Stable with Ceramic or Tantalum Capacitor
- Current Limit Protection
- Over-Temperature Protection
- RoHS Compliant and Halogen Free

### Ordering Information

RT9067-	□□□□	
	Package Type	
	B : SOT-23-5	
	X5 : SOT-89-5	
	Lead Plating System	
	G : Green (Halogen Free and Pb Free)	
	Output Voltage	
	25 : 2.5V	
	30 : 3.0V (For SOT-23-5 only)	
	33 : 3.3V	
	36 : 3.6V (For SOT-23-5 only)	
	42 : 4.2V	
	50 : 5V	
	90 : 9V	

Note :

Richtek products are :

- ▶ RoHS compliant and compatible with the current requirements of IPC/JEDEC J-STD-020.
- ▶ Suitable for use in SnPb or Pb-free soldering processes.

### Simplified Application Circuit

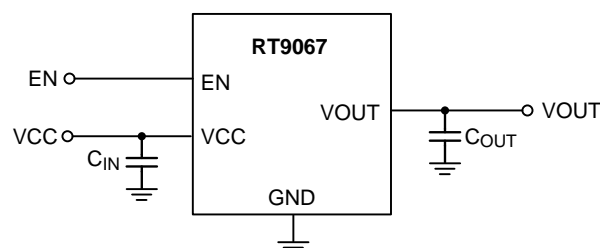

## Pin Configuration

(TOP VIEW)

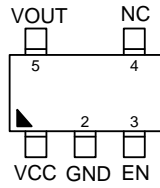

SOT-23-5

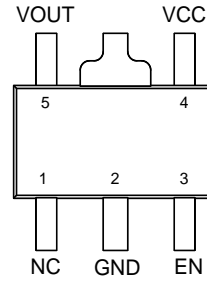

SOT-89-5

## Functional Pin Description

Pin No.		Pin Name	Pin Function
SOT-23-5	SOT-89-5		
1	4	VCC	Supply voltage input.
2	2	GND	Ground.
3	3	EN	Enable control input.
4	1	NC	No internal connection.
5	5	VOUT	Output of the regulator.

## Functional Block Diagram

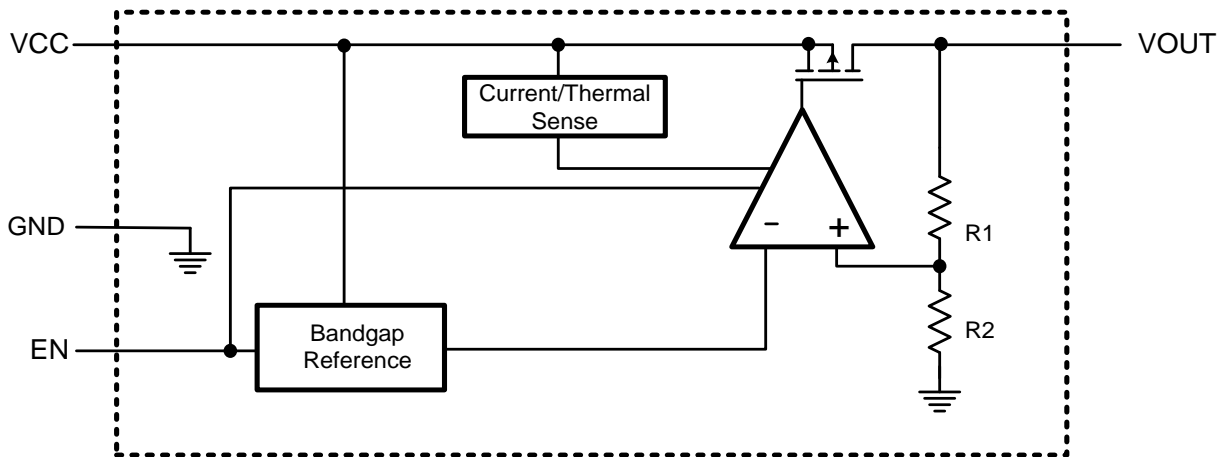

## **Operation**

### **Basic Operation**

The RT9067 is a low quiescent current linear regulator designed especially for low external component systems. The input voltage range is from 3.5V to 14V. The minimum required output capacitance for stable operation is 1 $\mu$ F effective capacitance after consideration of the temperature and voltage coefficient of the capacitor.

### **Output Transistor**

The RT9067 builds in a P-MOSFET output transistor which provides a low switch-on resistance for low dropout voltage applications.

### **Error Amplifier**

The Error Amplifier compares the internal reference voltage with the output feedback voltage from the internal divider, and controls the Gate voltage of P-MOSFET to support good line regulation and load regulation at output voltage.

### **Enable**

The RT9067 delivers the output power when it is set to enable state. When it works in disable state, there is no output power and the operation quiescent current is zero.

### **Current Limit Protection**

The RT9067 provides current limit function to prevent the device from damages during over-load or shorted-circuit conditions. This current is detected by an internal sensing transistor.

### **Over-Temperature Protection**

The over-temperature protection function turns off the P-MOSFET when the junction temperature exceeds 150°C (typ.) and the output current exceeds 30mA. Once the junction temperature cools down by approximately 20°C, the regulator automatically resumes operation.

## Absolute Maximum Ratings (Note 1)

- VCC, EN to GND ----- -0.3V to 15V
- VOUT to GND
  - RT9067-90 ----- -0.3V to 15V
  - RT9067-25/ RT9067-33/RT9067-50 ----- -0.3V to 6V
- VOUT to VCC ----- -15V to 0.3V
- Power Dissipation, P<sub>D</sub> @ T<sub>A</sub> = 25°C
  - SOT-23-5 ----- 0.45W
  - SOT-89-5 ----- 0.87W
- Package Thermal Resistance (Note 2)
  - SOT-23-5, θ<sub>JA</sub> ----- 218.1°C/W
  - SOT-89-5, θ<sub>JA</sub> ----- 113.9°C/W
- Lead Temperature (Soldering, 10 sec) ----- 260°C
- Junction Temperature ----- 150°C
- Storage Temperature Range ----- -60°C to 150°C
- ESD Susceptibility (Note 3)
  - HBM (Human Body Model) ----- 2kV

## Recommended Operating Conditions (Note 4)

- Supply Input Voltage, VCC ----- 3.5V to 14V
- Junction Temperature Range ----- -40°C to 125°C
- Ambient Temperature Range ----- -40°C to 85°C

## Electrical Characteristics

(V<sub>OUT</sub> +1 < V<sub>CC</sub> < 14V, T<sub>A</sub> = 25°C, unless otherwise specified)

Parameter	Symbol	Test Conditions	Min	Typ	Max	Unit
Supply Voltage	V <sub>CC</sub>		3.5	--	14	V
Output Voltage Range	V <sub>OUT</sub>		2.5	--	12	V
DC Output Accuracy	ΔV <sub>OUT</sub>	I <sub>LOAD</sub> = 1mA	-2	--	2	%
Dropout Voltage	V <sub>DROP</sub>	I <sub>LOAD</sub> = 100mA, V <sub>CC</sub> > 4.5V	--	0.4	1.2	V
		I <sub>LOAD</sub> = 100mA, V <sub>CC</sub> > 3.5V and < 4.5V	--	--	1.5	V
VCC Consumption Current	I <sub>Q</sub>	I <sub>LOAD</sub> = 0mA, V <sub>OUT</sub> ≤ 5.5V	--	2	--	μA
		I <sub>LOAD</sub> = 0mA, V <sub>OUT</sub> > 5.5V	--	3.5	--	μA
Shutdown GND Current		V <sub>EN</sub> = 0V	--	0.1	--	μA
Shutdown Leakage Current		V <sub>EN</sub> = 0V, V <sub>OUT</sub> = 0V	--	0.1	--	μA
EN Input Current	I <sub>EN</sub>	V <sub>EN</sub> = 14V	--	0.1	--	μA

Parameter	Symbol	Test Conditions	Min	Typ	Max	Unit
Line Regulation	$\Delta V_{LINE}$	$I_{LOAD} = 1mA, 5.5V < V_{CC} < 14V$	--	--	0.4	%
		$I_{LOAD} = 1mA, 3.5V < V_{CC} < 5.5V$	--	0.1	0.3	%
Load Regulation	$\Delta V_{LOAD}$	$1mA < I_{LOAD} < 200mA$	--	0.5	1	%
Output Current Limit	$I_{LIM}$	$V_{OUT} = 0.5 \times V_{OUT(normal)}$	210	350	490	mA
Enable Input Voltage	Logic-High	$V_{IH}$	--	--	1.7	V
	Logic-Low	$V_{IL}$	0.6	--	--	
Thermal Shutdown Temperature	$T_{SD}$	$I_{LOAD} = 30mA$	--	150	--	°C
Thermal Shutdown Hysteresis	$\Delta T_{SD}$		--	20	--	°C

**Note 1.** Stresses beyond those listed “Absolute Maximum Ratings” may cause permanent damage to the device. These are stress ratings only, and functional operation of the device at these or any other conditions beyond those indicated in the operational sections of the specifications is not implied. Exposure to absolute maximum rating conditions may affect device reliability.

**Note 2.**  $\theta_{JA}$  is measured at  $T_A = 25^\circ C$  on a high effective thermal conductivity four-layer test board per JEDEC 51-7.  $\theta_{JC}$  is measured at the exposed pad of the package.

**Note 3.** Devices are ESD sensitive. Handling precaution is recommended.

**Note 4.** The device is not guaranteed to function outside its operating conditions.

### Typical Application Circuit

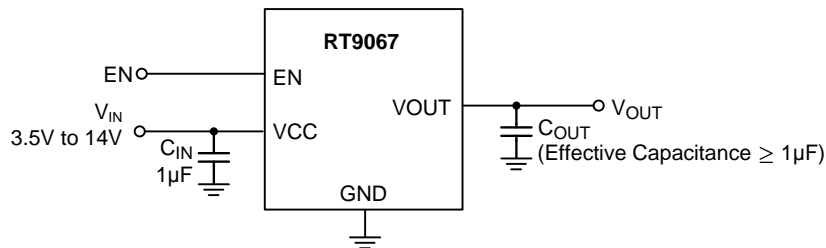

## Typical Operating Characteristics

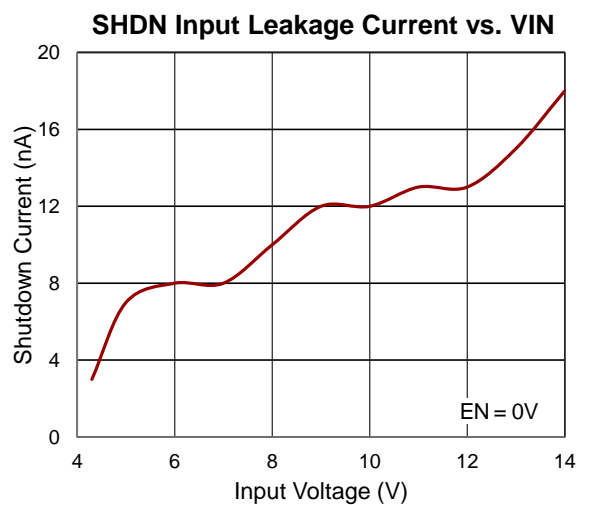
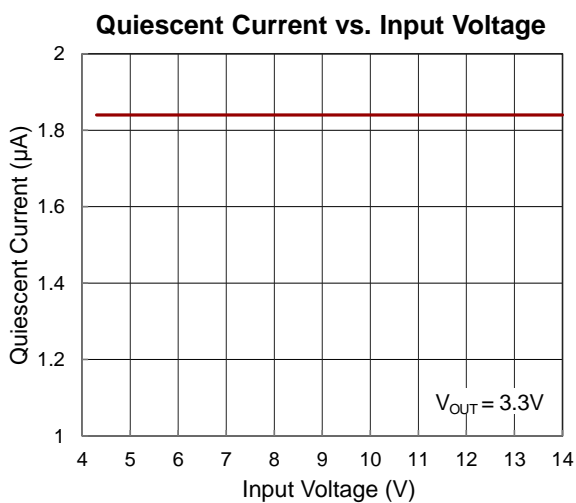
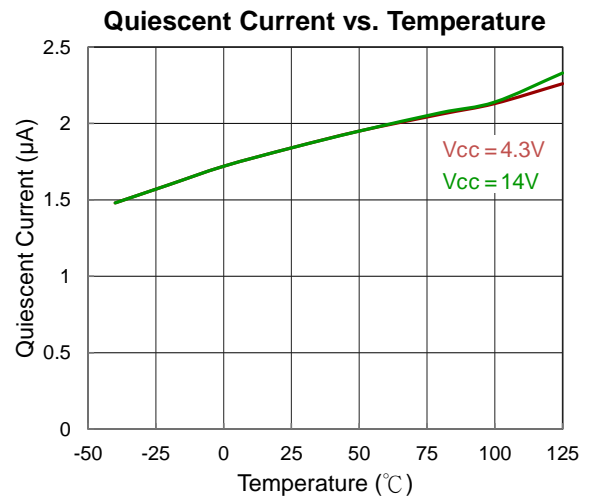
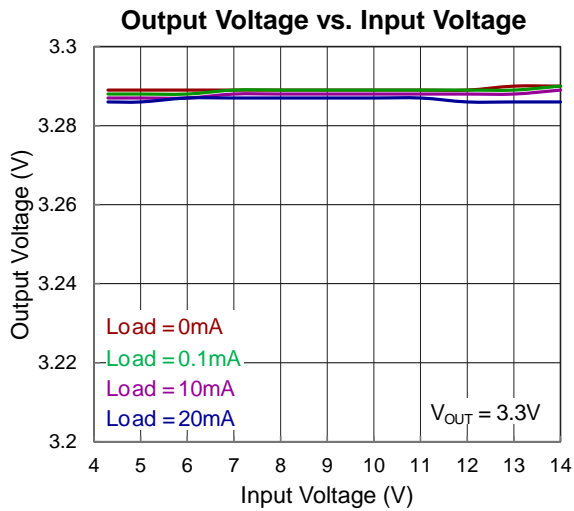
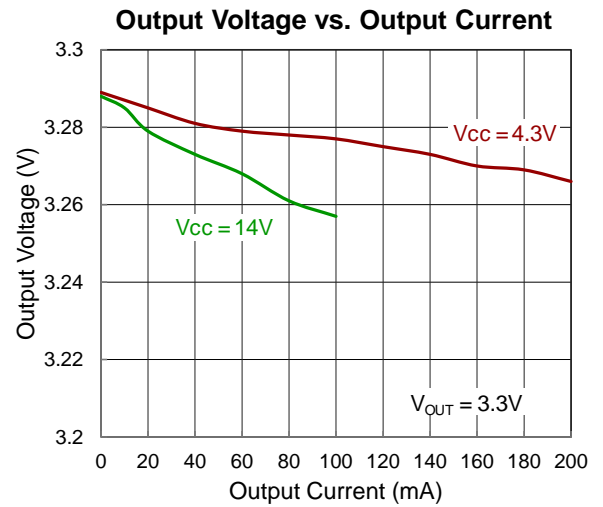
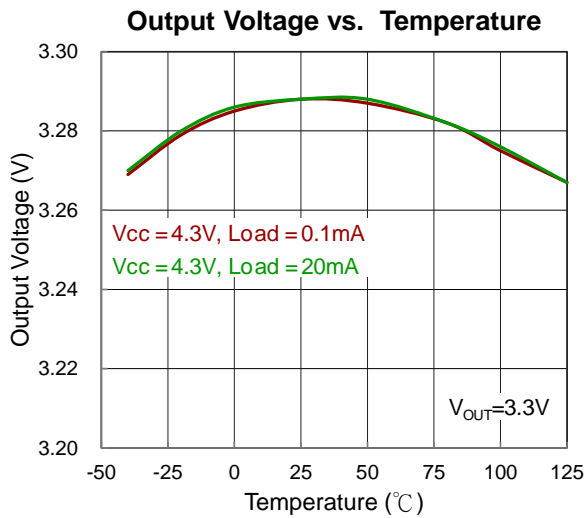

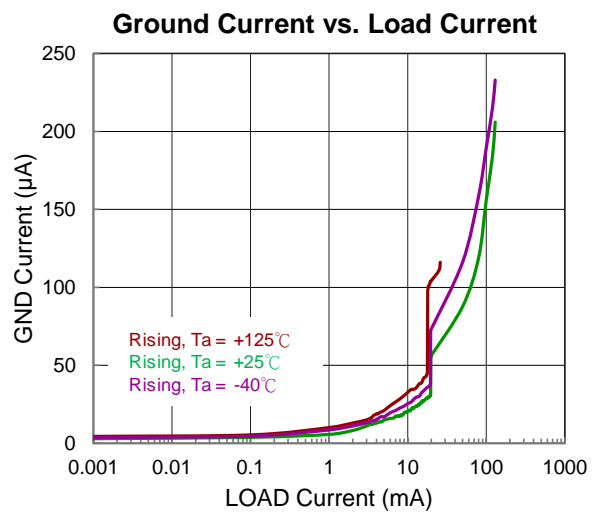
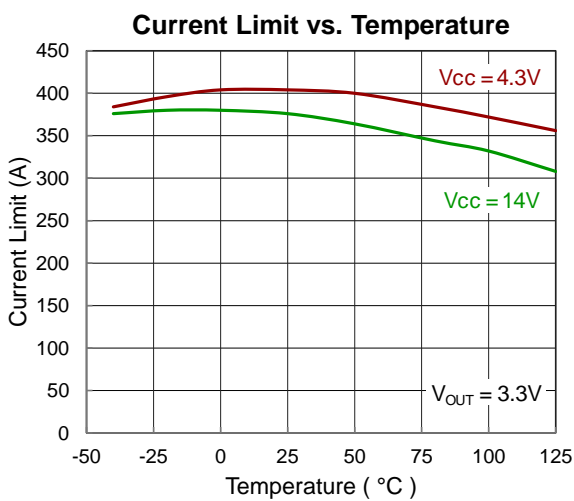
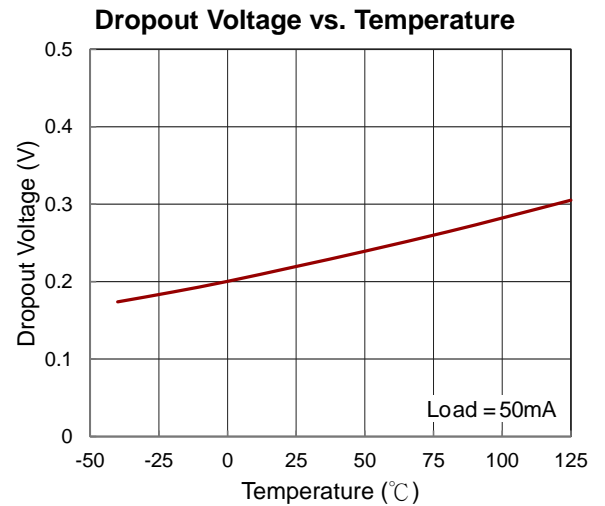
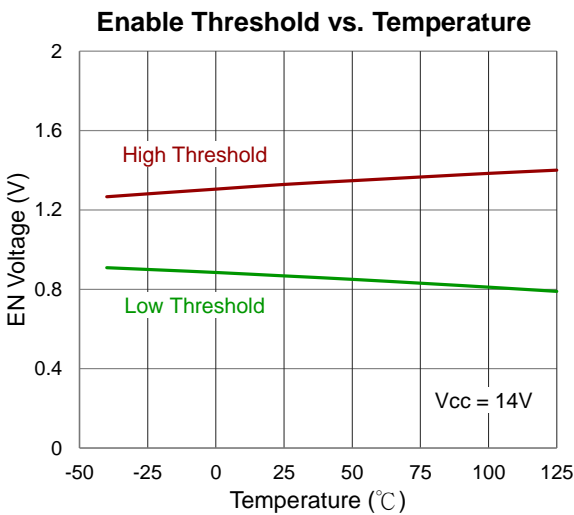
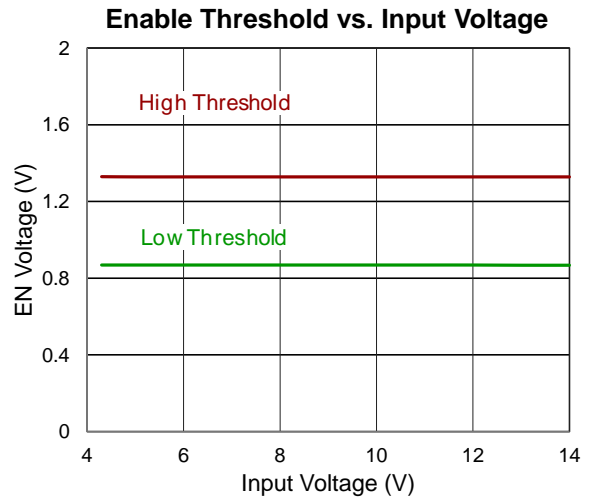
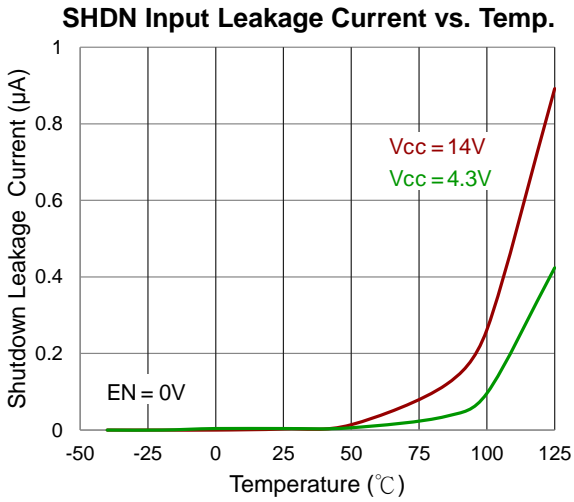

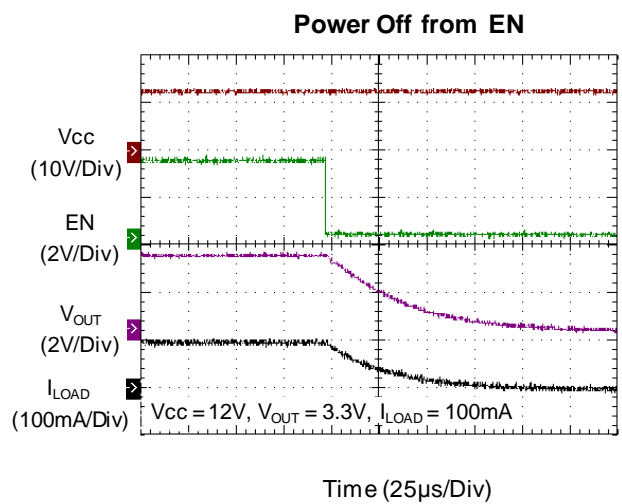
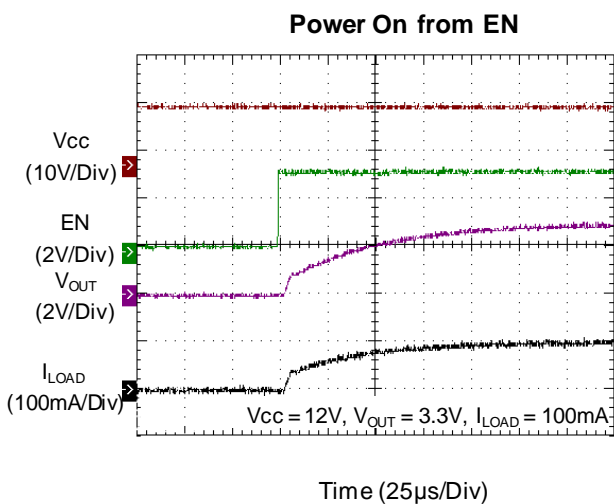
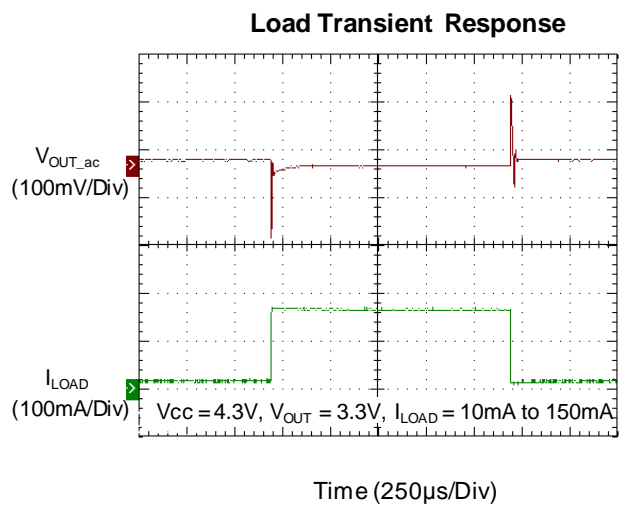
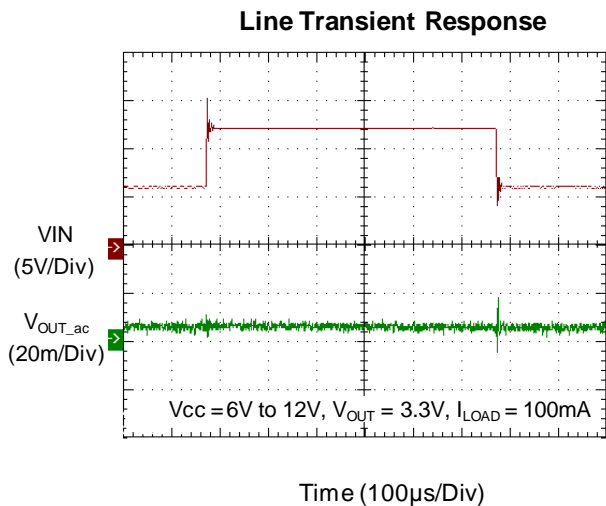
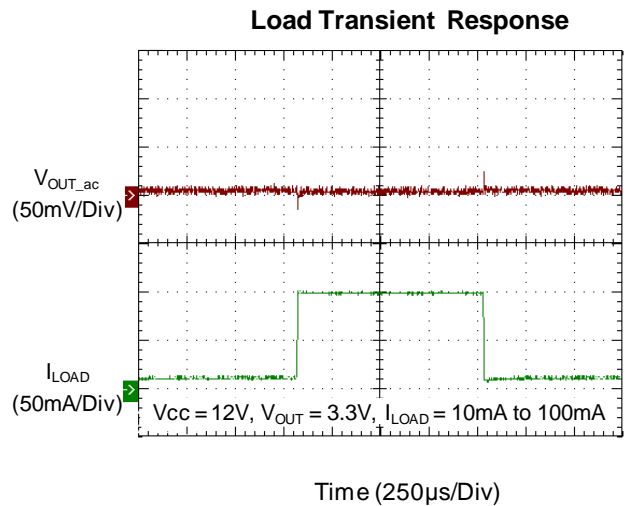
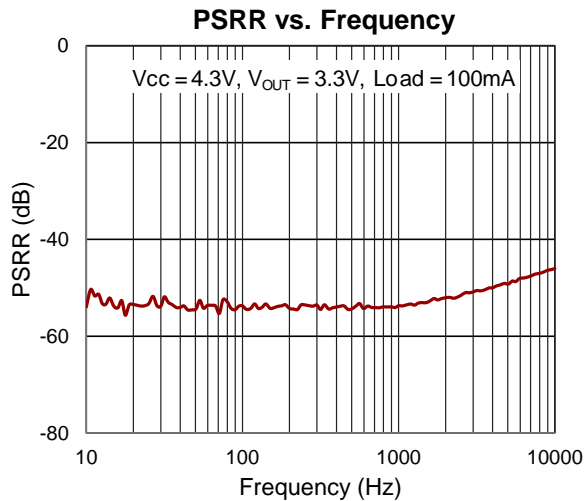



**Application Information**

Like any low dropout linear regulator, the RT9067's external input and output capacitors must be properly selected for stability and performance. Use a 1μF or larger input capacitor and place it close to the IC's VCC and GND pins. Any output capacitor meeting the minimum 1mΩ ESR (Equivalent Series Resistance) and effective capacitance larger than 1μF requirement may be used. Place the output capacitor close to the IC's VOUT and GND pins. Increasing capacitance and decreasing ESR can improve the circuit's PSRR and line transient response.

**Enable**

The RT9067 goes into sleep mode when the EN pin is in a logic low condition. During this condition, the RT9067 has an EN pin to turn on or turn off the regulator, When the EN pin is in logic high, the regulator will be turned on. The shutdown current is 0μA typical. The EN pin may be directly tied to Vcc to keep the part on. The Enable input is CMOS logic and cannot be left floating.

**PSRR**

The power supply rejection ratio (PSRR) is defined as the gain from the input to output divided by the gain from the supply to the output. The PSRR is found to be

$$PSRR=20 \times \log\left(\frac{\Delta\text{Gain Error}}{\Delta\text{Supply}}\right)$$

Note that in heavy load measuring, Δsupply will cause Δtemperature. And Δtemperature will cause Δoutput voltage. So the temperature effect is include in heavy load PSRR measuring.

**Current Limit**

The RT9067 contains an independent current limiter, which monitors and controls the pass transistor's gate voltage, limiting the output current to 0.35A (typ.). The output can be shorted to ground indefinitely without damaging the part.

**Thermal Considerations**

For continuous operation, do not exceed absolute maximum junction temperature. The maximum power dissipation depends on the thermal resistance of the IC package, PCB layout, rate of surrounding airflow, and difference between junction and ambient temperature. The maximum power dissipation can be calculated by the following formula:

$$P_{D(MAX)} = (T_{J(MAX)} - T_A) / \theta_{JA}$$

where  $T_{J(MAX)}$  is the maximum junction temperature,  $T_A$  is the ambient temperature, and  $\theta_{JA}$  is the junction to ambient thermal resistance.

For recommended operating condition specifications, the maximum junction temperature is 125°C. The junction to ambient thermal resistance,  $\theta_{JA}$ , is layout dependent. For SOT-23-5 packages, the thermal resistance,  $\theta_{JA}$ , is 218.1°C/W on a standard JEDEC 51-7 four-layer thermal test board. For SOT-89-5 packages, the thermal resistance,  $\theta_{JA}$ , is 113.9°C/W on a standard JEDEC 51-7 four-layer thermal test board. The maximum power dissipation at  $T_A = 25^\circ\text{C}$  can be calculated by the following formula :

$$P_{D(MAX)} = (125^\circ\text{C} - 25^\circ\text{C}) / (218.1^\circ\text{C/W}) = 0.4585\text{W for SOT-23-5 package}$$

$$P_{D(MAX)} = (125^\circ\text{C} - 25^\circ\text{C}) / (113.9^\circ\text{C/W}) = 0.8779\text{W for SOT-89-5 package}$$

The maximum power dissipation depends on the operating ambient temperature for fixed  $T_{J(MAX)}$  and thermal resistance,  $\theta_{JA}$ . The derating curve in Figure 1 allows the designer to see the effect of rising ambient temperature on the maximum power dissipation.

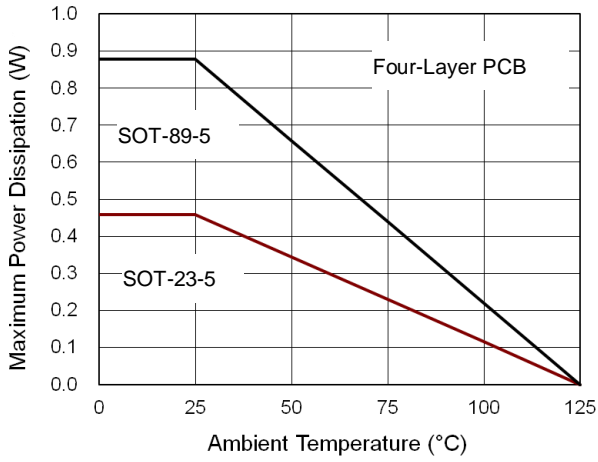
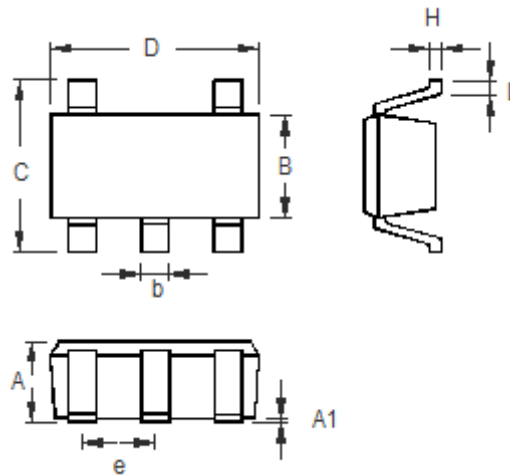

Figure 1. Derating Curve of Maximum Power Dissipation

**Outline Dimension**



Symbol	Dimensions In Millimeters		Dimensions In Inches	
	Min	Max	Min	Max
A	0.889	1.295	0.035	0.051
A1	0.000	0.152	0.000	0.006
B	1.397	1.803	0.055	0.071
b	0.356	0.559	0.014	0.022
C	2.591	2.997	0.102	0.118
D	2.692	3.099	0.106	0.122
e	0.838	1.041	0.033	0.041
H	0.080	0.254	0.003	0.010
L	0.300	0.610	0.012	0.024

**SOT-23-5 Surface Mount Package**

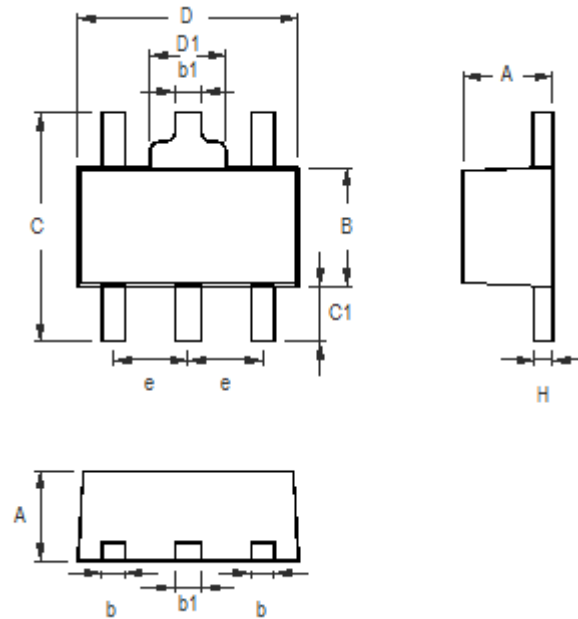

Sym bol	Dimensions In Millimeters		Dimensions In Inches	
	Min	Max	Min	Max
A	1.400	1.600	0.055	0.063
b	0.360	0.508	0.014	0.020
B	2.400	2.600	0.094	0.102
b1	0.406	0.533	0.016	0.021
C	3.937	4.250	0.155	0.167
C1	0.800	1.194	0.031	0.047
D	4.400	4.600	0.173	0.181
D1	1.397	1.700	0.055	0.067
e	1.400	1.600	0.055	0.063
H	0.356	0.430	0.014	0.017

**5-Lead SOT-89 Surface Mount Package**

**Richtek Technology Corporation**

14F, No. 8, Tai Yuen 1<sup>st</sup> Street, Chupei City  
 Hsinchu, Taiwan, R.O.C.  
 Tel: (8863)5526789

Richtek products are sold by description only. Customers should obtain the latest relevant information and data sheets before placing orders and should verify that such information is current and complete. Richtek cannot assume responsibility for use of any circuitry other than circuitry entirely embodied in a Richtek product. Information furnished by Richtek is believed to be accurate and reliable. However, no responsibility is assumed by Richtek or its subsidiaries for its use; nor for any infringements of patents or other rights of third parties which may result from its use. No license is granted by implication or otherwise under any patent or patent rights of Richtek or its subsidiaries.

Copyright © 2017 Richtek Technology Corporation. All rights reserved. **RICHTEK** is a registered trademark of Richtek Technology Corporation.