

Click [here](#) for production status of specific part numbers.

MAX40662 Evaluation Kit

Evaluates: MAX40662

General Description

The MAX40662 evaluation kit (EV kit) is a fully assembled electrical demonstration kit that provides a proven design to evaluate the MAX40662 quad transimpedance amplifiers.

Note that the MAX40662 EV kit provides an electrical interface to the IC that is similar, but not identical, to a photodiode.

The MAX40662 EV kit printed circuit board (PCB) comes with a MAX40662ATE/VY+ installed.

Features and Benefits

- Easy Electrical Evaluation of the MAX40662
- EV Kit Designed for 50Ω Interfaces
- -40°C to +125°C Temperature Range
- Accommodates Easy-to-Use Components
- Proven PCB Layout
- Fully Assembled and Tested

[Ordering Information](#) appears at end of data sheet.

MAX40662 EV Kit Photo

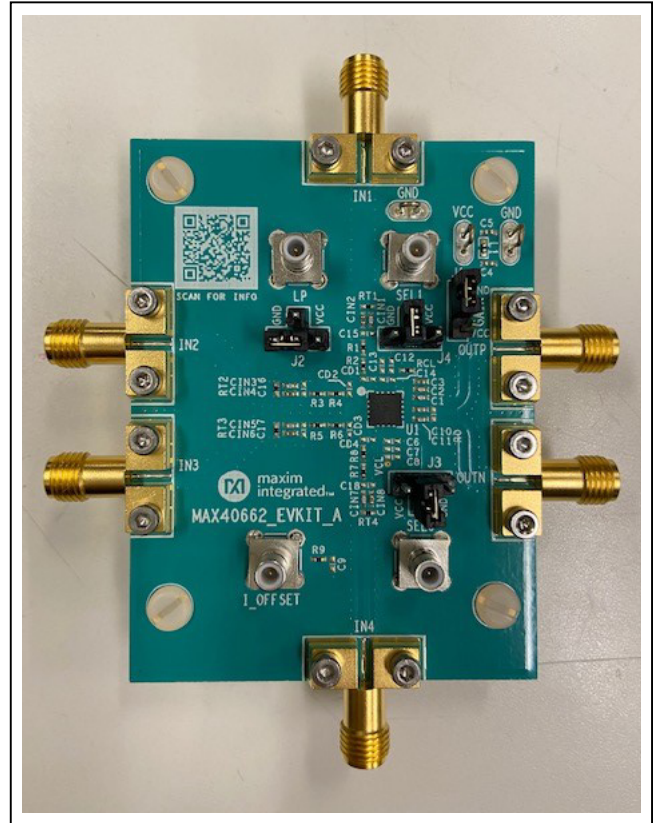

Quick Start

Required Equipment

- +3.6V, 100mA DC Power Supply
- Signal Source Up to 1GHz
- 500MHz to 2.5GHz Oscilloscope

Procedure

The MAX40662 EV kit is fully assembled and tested. Follow the below to verify board operation:

Caution: Do not turn on the power supply or the electronic load until all the connections are complete.

- 1) Connect a +3.3V supply and ground to VCC connector and GND return pad of the EV kit, respectively. Disable the output of the power supply.
- 2) Verify all the shunts are in default positions, as shown in [Table 1](#).
- 3) Connect a signal source to the IN1 edge-mount SMA input. Set the signal amplitude to 12.5mV_{p,p} (4.4mV_{rms} or -34dBm), which corresponds to 5μA_{p,p}. Set the frequency to 100MHz. Disable the signal generator output.
- 4) Connect the OUTP and OUTN edge-mount SMA outputs to the 50Ω inputs of a high-speed oscilloscope.
- 5) Enable the power supply and signal generator output. Observe the outputs from OUTP and OUTN on the oscilloscope.

Detailed Description of Hardware

The MAX40662 accepts AC- and DC-coupled input from a high-speed photodiode. The EV kit facilitates evaluation of the MAX40662 TIA without a photodiode. The MAX40662 TIA is designed to be used with optical transceiver systems when the detector's (APD, PIN diodes) cathode is connected to the IN_ pin of the IC. The device is to be used when AC input currents are flowing out of the device at the IN_ pin of the IC.

When an APD with negative bias voltage is connected to the TIA input, the signal current flows out of the amplifier's summing node. The input current flows through an internal load resistor to develop a voltage that is then applied to the input of the second stage. An internal clamp circuit protects against input currents up to 100mA up to 100ns and up to 2A for 10ns pulses at low duty cycles. For more information about the device, refer to the IC data sheet.

Channel Selection

The MAX40662 EV kit uses jumpers J3 and J4 to select the input channel to pass to the outputs. [Table 2](#) provides the four combinations to select the desired channels.

Table 1. MAX40662 Jumper Descriptions

JUMPER	SHUNT POSITION	DESCRIPTION
J1	1-2	High Gain Mode Selected (50kΩ Transimpedance)
	2-3*	Low Gain Mode Selected (25kΩ Transimpedance)
J2	1-2	Disable Mode. Disables U1 or low power.
	1-3	Connects to LP SMA.
	1-4*	Active Mode. Enables U1.
J3	1-2*	Channel Selection Input SEL0. Connects to ground.
	1-3	Channel Selection Input SEL0. Connects to SEL0 SMA.
	1-4	Channel Selection Input SEL0. Connects VCC.
J4	1-2*	Channel Selection Input SEL1. Connects to ground.
	1-3	Channel Selection Input SEL1. Connects to SEL1 SMA.
	1-4	Channel Selection Input SEL1. Connects VCC.

*Default position.

Table 2. Jumper Description for Channel Selection

INPUT CHANNEL	JUMPER J4 (SEL1) SHUNT POSITION	JUMPER J3 (SEL0) SHUNT POSITION
1	1-2*	1-2*
2	1-2	1-4
3	1-4	1-2
4	1-4	1-4

Theory of Operation

The MAX40662 EV kit provides photodiode emulation using a simplified electrical photodiode model. The model provides a 50Ω electrical input termination, and resistors that convert the high-speed input voltage to high-speed current. A DC path is provided to model the average photodiode current.

Test Interface

The MAX40662 outputs are back-terminated with 50Ω. When terminating the outputs to a 50Ω oscilloscope, AC-coupling capacitors C10 and C11 are present and resistor R0 is not installed. When interfacing with subsequent amplifiers or LVDS capable devices, AC-coupling capacitors C10 and C11 are present and 100Ω at resistor R0 is installed.

Current Pulse Measurements

To perform pulse measurements, the current pulses are created by providing a voltage pulse at IN_ edge-mount SMAs. The input IN1 series resistance combination (R1+R2) respectively determines the amplitude of the current pulse. Note: The same concept applies to all input

channels: resistors R3 and R4 for input IN2, resistors R5 and R6 for input IN3, and resistors R7 and R8 for input IN4.

Both AC- and DC-coupling at the IN1 input may be used for this test. When using DC-blocking capacitors, CIN1 and CIN2 are used in conjunction with the test. When providing the input voltage pulse at the IN_ edge-mount SMA, the DC-blocking capacitors CIN1 and CIN2 are replaced with a 0Ω short to DC-couple the input to the MAX40662. Note: The same concept applies to all input channels: DC-blocking capacitors CIN3 and CIN4 for input IN2, DC-blocking capacitors CIN5 and CIN6 for input IN3, and DC-blocking capacitors CIN7 and CIN8 for input IN4.

The following resistor setting $R_S = (R1+R2)$ is shown in [Table 3](#) to create the large-signal current amplitude pulses.

Noise Measurements

Remove the input resistors and shunt capacitor before attempting noise measurement. With the input resistors and shunt capacitor removed, the total capacitance at the IN input is equal to 0.5pF.

Table 3. Different Values of R_S (R1+R2) for Different Input Current Pulse Amplitudes

INPUT SERIES RESISTANCE R_S (Ω)	GENERATOR INPUT HIGH VOLTAGE (V)	GENERATOR INPUT LOW VOLTAGE (V)	GENERATED INPUT CURRENT STEP FROM IN1 (mA)
1	0.855	0.15	10
	0.855	-0.9	50
	0.855	-2.2	100
	0.855	-3.3	150

Ordering Information

PART	TYPE
MAX40662EVKIT#	EV Kit

#Denotes RoHS compliant.

MAX40662 EV Kit Bill of Materials

ITEM	REF_DES	DNI/DNP	QTY	MFG PART #	MANUFACTURER	VALUE	DESCRIPTION	COMMENTS
1	C1	-	1	C0402C101J5GAC; NMC0402NPO101J; CC0402JRNPO9BN101; GRM1555C1H101JA01; C1005C0G1H101J050BA; CGA2B2C0G1H101J050BA	KEMET;NIC COMPONENTS CORP.;YAGEO PHICOMP;MURATA;TDK;TDK	100PF	CAPACITOR; SMT (0402); CERAMIC CHIP; 100PF; 50V; TOL=5%; TG=-55 DEGC TO +125 DEGC; TC=C0G	
2	C2	-	1	C0402X7R500-222KNE; GRM155R71H222KA01	VENKEL LTD.;MURATA	2200PF	CAPACITOR; SMT (0402); CERAMIC CHIP; 2200PF; 50V; TOL=10%; TG=-55 DEGC TO +125 DEGC; TC=X7R	
3	C3	-	1	C0402X5R100-105KNE; GRM155R61A105KE15	VENKEL LTD.;MURATA	1UF	CAPACITOR; SMT (0402); CERAMIC CHIP; 1UF; 10V; TOL=10%; MODEL=; TG=-55 DEGC TO +85 DEGC; TC=X5R	
4	C4, C10, C11	-	3	GRM155R61C104KA88	MURATA	0.1UF	CAPACITOR; SMT (0402); CERAMIC; 0.1UF; 16V; TOL=10%; MODEL=GRM SERIES; TG=-55 DEGC to +85 DEGC; TC=X5R	
5	C5	-	1	C0402X5R6R3-225MNP; C0402C225M9PAC; GRM155R60J225ME15; JMK105BJ225MV	VENKEL;KEMET;MURATA; TAIYO YUDEN	2.2UF	CAPACITOR; SMT; 0402; CERAMIC; 2.2uF; 6.3V; 20%; X5R; -55degC to + 85degC; 0 +/-15% degC MAX.	
6	CIN1, CIN3, CIN5, CIN7	-	4	C0402C101K5GAC; C1005C0G1H101K050BA	KEMET;TDK	100PF	CAPACITOR; SMT; 0402; CERAMIC; 100pF; 50V; 10%; COG; -55degC to + 125degC; 0 +/-30PPM/degC	
7	CIN2, CIN4, CIN6, CIN8	-	4	GRM155R71E104KE14; C1005X7R1E104K050BB; TMK105B7104KVH; CGJ2B3X7R1E104K050BB	MURATA;TDK;TAIYO YUDEN;TDK	0.1UF	CAPACITOR; SMT (0402); CERAMIC CHIP; 0.1UF; 25V; TOL=10%; MODEL=GRM SERIES; TG=-55 DEGC TO +125 DEGC; TC=X7R	
8	GND1, GND2, VCC	-	3	9020 BUSS	WEICO WIRE	MAXIMPAD	EVK KIT PARTS; MAXIM PAD; WIRE; NATURAL; SOLID; WEICO WIRE; SOFT DRAWN BUS TYPE-S; 20AWG	
9	IN1-IN4, OUTN, OUTP	-	6	32K243-40ML5	ROSENBERGER	32K243-40ML5	CONNECTOR; FEMALE; SMT; SMA JACK PCB; RIGHT ANGLE; 2PINS	
10	L_OFFSET, LP, SEL0, SEL1	-	4	131-3701-266	JOHNSON COMPONENTS	131-3701-266	CONNECTOR; MALE; THROUGH HOLE; SMB JACK VERTICAL PCB MOUNT; STRAIGHT; 5PINS	
11	J1	-	1	PCC03SAAN	SULLINS	PCC03SAAN	CONNECTOR; MALE; THROUGH HOLE; BREAKAWAY; STRAIGHT THROUGH; 3PINS; -65 DEGC TO +125 DEGC	
12	J2-J4	-	3	PEC04SAAN	SULLINS ELECTRONICS CORP.	PEC04SAAN	CONNECTOR; MALE; THROUGH HOLE; BREAKAWAY; STRAIGHT; 4PINS	
13	L1	-	1	BLM15BD601SN1	MURATA	600	INDUCTOR; SMT (0402); FERRITE-BEAD; 600; TOL=+-25%; 0.2A	
14	MH1-MH4	-	4	P440.375	GENERIC PART	N/A	MACHINE SCREW; SLOTTED; PAN; 4-40IN; 3/8IN; NYLON	
15	MH1-MH4	-	4	1902B	GENERIC PART	N/A	STANDOFF; FEMALE-THREADED; HEX; 4-40IN; 3/8IN; NYLON	
16	R1-R8	-	8	ERJ-2RKF1241	PANASONIC	1.24K	RESISTOR; 0402; 1.24K OHM; 1%; 100PPM; 0.10W; THICK FILM	
17	R9, RCL	-	2	ERJ-2GE0R00	PANASONIC	0	RESISTOR; 0402; 0 OHM; 0%; JUMPER; 0.10W; THICK FILM	
18	RT1-RT4	-	4	TNPW040249R9BE; RG1005P-49R9-B-T; ERA-2AEB49R9	SUSUMU CO LTD.;PANASONIC; VISHAY	49.9	RESISTOR; 0402; 49.9 OHM; 0.1%; 25PPM; 0.063W; THICK FILM	
19	SU1-SU4	-	4	S1100-B;SX1100-B; STC02SYAN	KYCON;KYCON;SULLINS ELECTRONICS CORP.	SX1100-B	TEST POINT; JUMPER; STR; TOTAL LENGTH=0.24IN; BLACK; INSULATION=PBT;PHOSPHOR BRONZE CONTACT=GOLD PLATED	
20	U1	-	1	MAX40662	MAXIM	MAX40662	EVKIT PART - IC; AMP; QUAD TRANSIMPEDANCE AMPLIFIER WITH INPUT CURRENT CLAMP AND MULTIPLEXER FOR LIDAR; PACKAGE OUTLINE DRAWING: 21-100204; PACKAGE CODE: T1644Y+5C; LAND PATTERN: 90-0070; TQFN16-EP	
21	PCB	-	1	MAX40662	MAXIM	PCB	PCB:MAX40662	
22	C6, C9, C14	DNP	0	C0402C101J5GAC; NMC0402NPO101J; CC0402JRNPO9BN101; GRM1555C1H101JA01; C1005C0G1H101J050BA; CGA2B2C0G1H101J050BA	KEMET;NIC COMPONENTS CORP.;YAGEO PHICOMP;MURATA;TDK;TDK	100PF	CAPACITOR; SMT (0402); CERAMIC CHIP; 100PF; 50V; TOL=5%; TG=-55 DEGC TO +125 DEGC; TC=COG	
23	C7, C13	DNP	0	C0402X7R500-222KNE; GRM155R71H222KA01	VENKEL LTD.;MURATA	2200PF	CAPACITOR; SMT (0402); CERAMIC CHIP; 2200PF; 50V; TOL=10%; TG=-55 DEGC TO +125 DEGC; TC=X7R	
24	C8, C12	DNP	0	C0402X5R100-105KNE; GRM155R61A105KE15	VENKEL LTD.;MURATA	1UF	CAPACITOR; SMT (0402); CERAMIC CHIP; 1UF; 10V; TOL=10%; MODEL=; TG=-55 DEGC TO +85 DEGC; TC=X5R	
25	C15-C18	DNP	0	GRM155R61C104KA88	MURATA	0.1UF	CAPACITOR; SMT (0402); CERAMIC; 0.1UF; 16V; TOL=10%; MODEL=GRM SERIES; TG=-55 DEGC to +85 DEGC; TC=X5R	
26	CD1-CD4	DNP	0	N/A	N/A	OPEN	PACKAGE OUTLINE 0402 NON-POLAR CAPACITOR	
27	R0	DNP	0	ERJ-2RKF1000	PANASONIC	100	RESISTOR; 0402; 100 OHM; 1%; 100PPM; 0.10W; THICK FILM	
TOTAL			61					

MAX40662 EV Kit Schematic

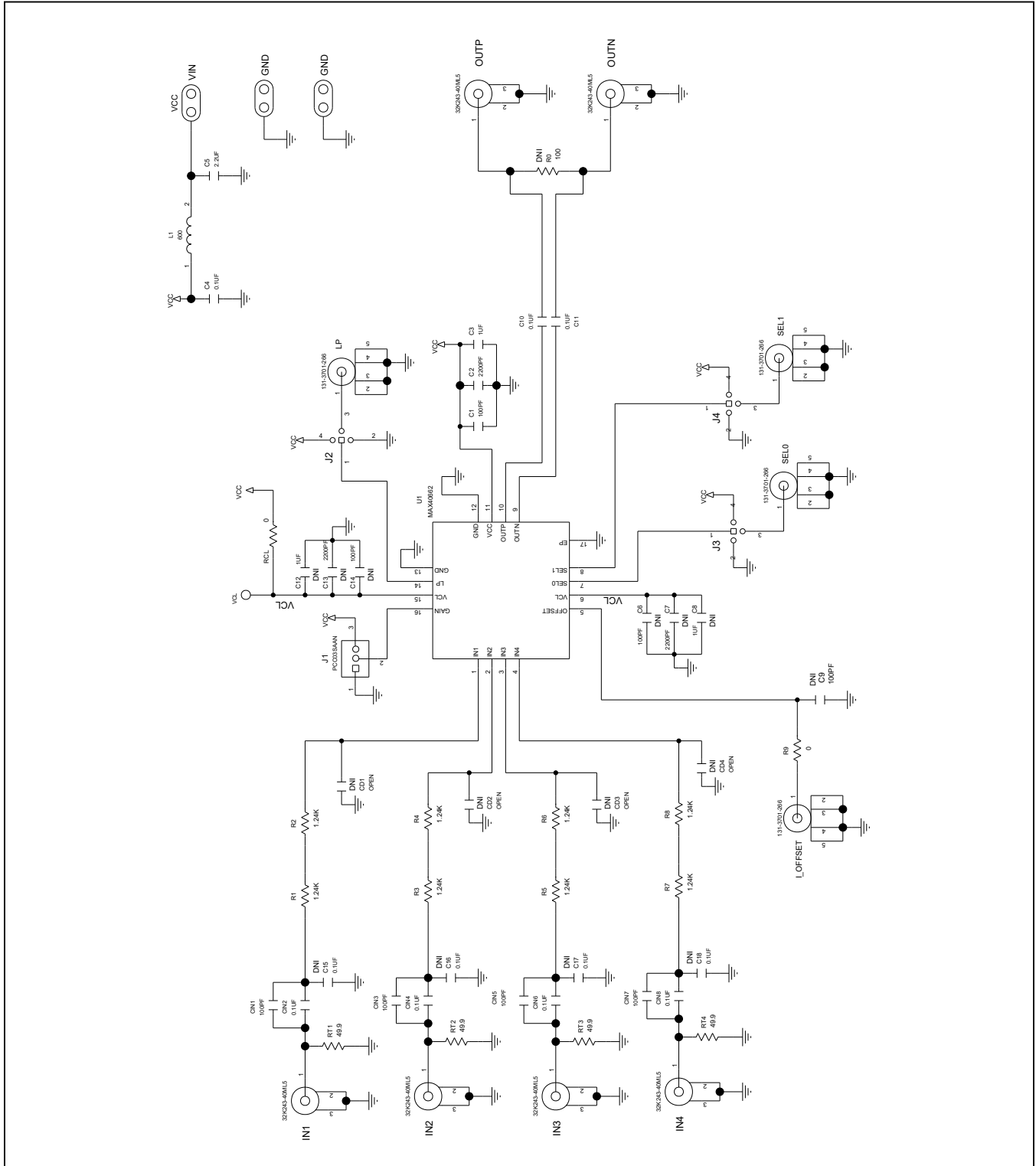

MAX40662 EV Kit PCB Layout Diagrams

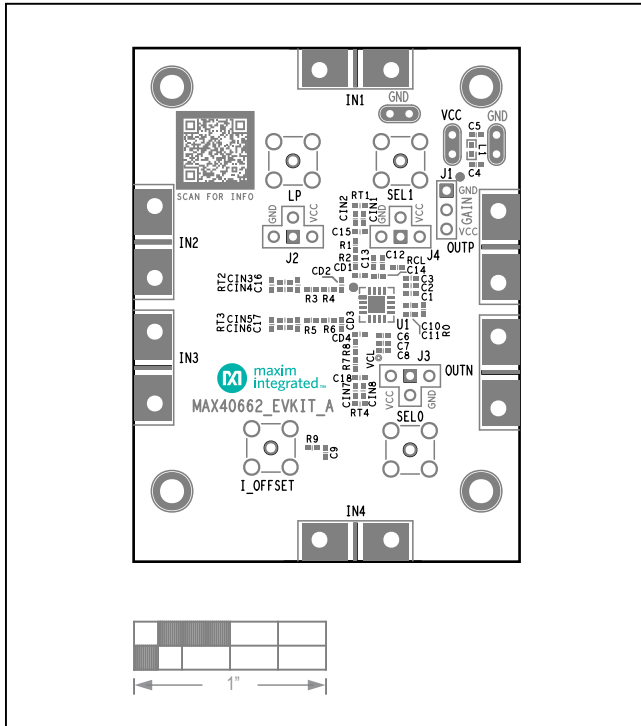

Silk Top

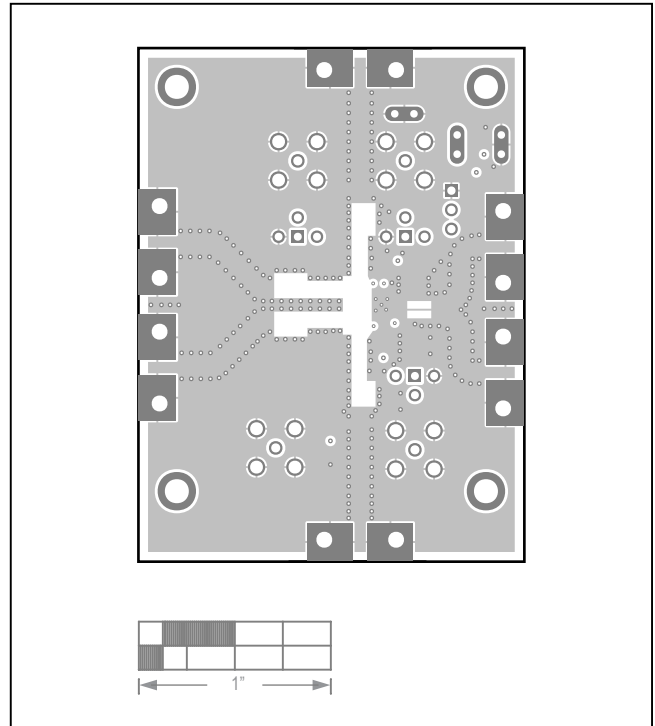

GND2

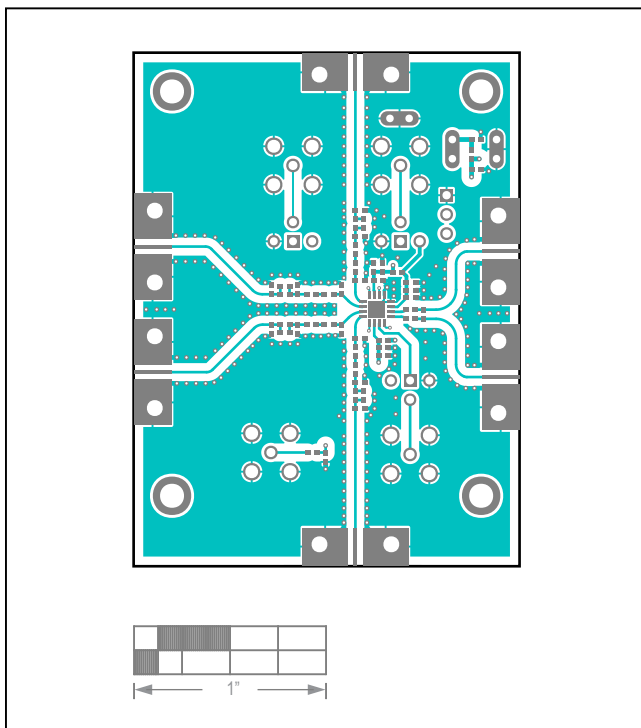

Top

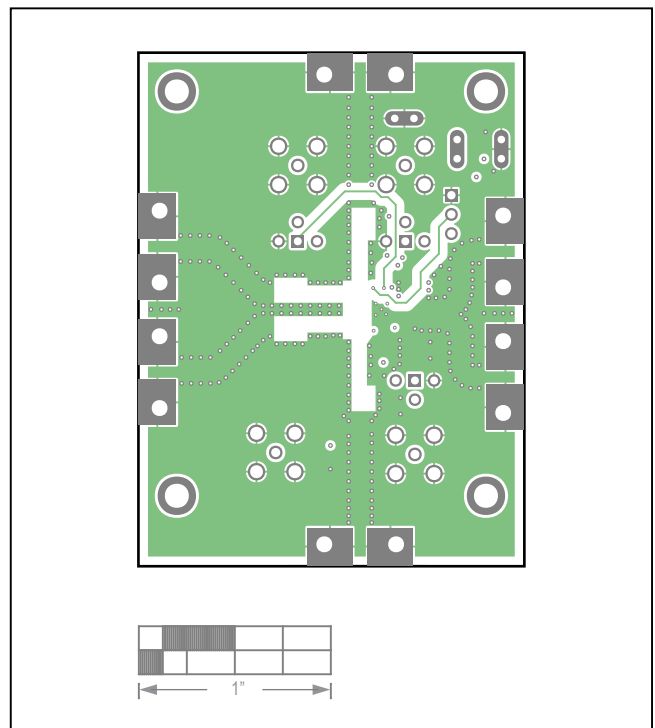

GND3

MAX40662 EV Kit PCB Layout Diagrams (continued)

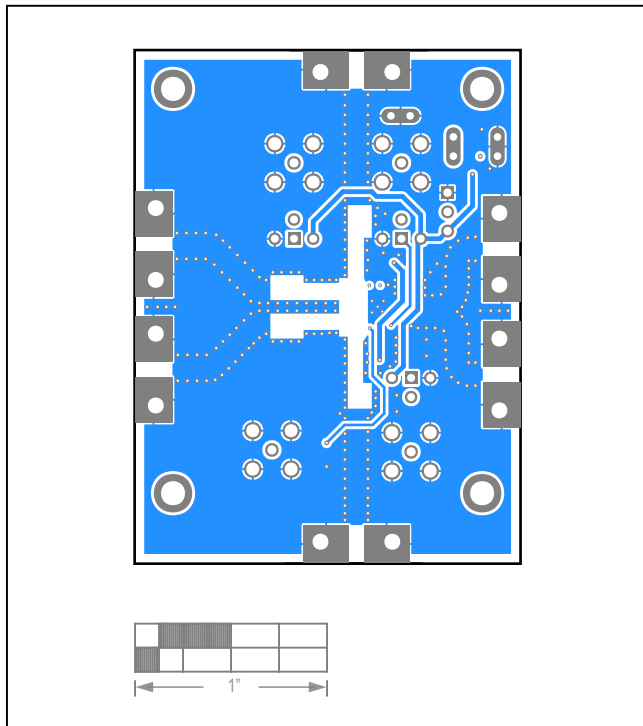

Bottom

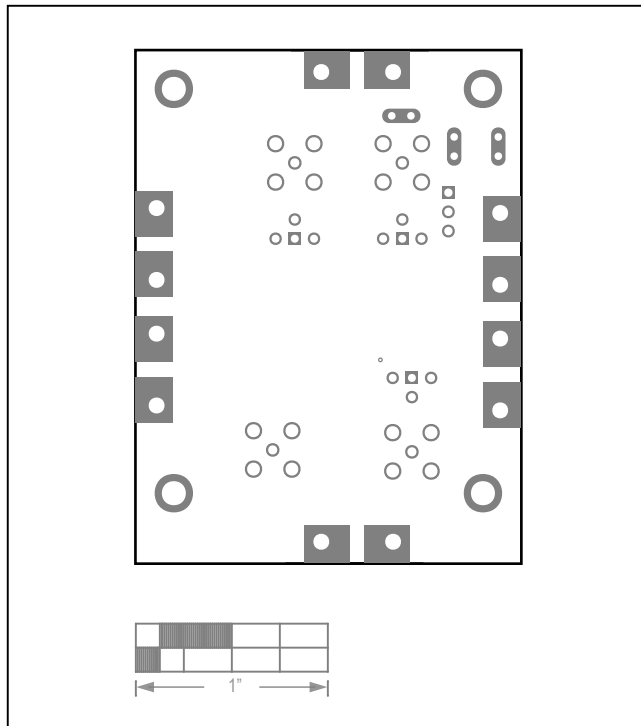

Silk Top

Revision History

REVISION NUMBER	REVISION DATE	DESCRIPTION	PAGES CHANGED
0	3/20	Initial release	—

For pricing, delivery, and ordering information, please visit Maxim Integrated's online storefront at <https://www.maximintegrated.com/en/storefront/storefront.html>.

Maxim Integrated cannot assume responsibility for use of any circuitry other than circuitry entirely embodied in a Maxim Integrated product. No circuit patent licenses are implied. Maxim Integrated reserves the right to change the circuitry and specifications without notice at any time.