

NTA4151P, NTE4151P

MOSFET – Single, P-Channel, Small Signal, Gate Zener, SC-75, SC-89

-20 V, -760 mA

Features

- Low $R_{DS(on)}$ for Higher Efficiency and Longer Battery Life
- Small Outline Package (1.6 x 1.6 mm)
- SC-75 Standard Gullwing Package
- ESD Protected Gate
- These Devices are Pb-Free, Halogen Free/BFR Free and are RoHS Compliant

Applications

- High Side Load Switch
- DC-DC Conversion
- Small Drive Circuits
- Battery Operated Systems such as Cell Phones, PDAs, Digital Cameras, etc.

MAXIMUM RATINGS ($T_J = 25^\circ\text{C}$ unless otherwise stated)

| Parameter | | Symbol | Value | Units |
|---|------------------------|----------------|------------|------------------|
| Drain-to-Source Voltage | | V_{DSS} | -20 | V |
| Gate-to-Source Voltage | | V_{GS} | ± 6.0 | V |
| Continuous Drain Current (Note 1) | Steady State | I_D | -760 | mA |
| Power Dissipation (Note 1) | Steady State | P_D | 301 | mW |
| SC-75 | | | 313 | |
| Pulsed Drain Current | $t_p = 10 \mu\text{s}$ | I_{DM} | ± 1000 | mA |
| Operating Junction and Storage Temperature | | T_J, T_{STG} | -55 to 150 | $^\circ\text{C}$ |
| Continuous Source Current (Body Diode) | | I_S | -250 | mA |
| Lead Temperature for Soldering Purposes (1/8 in from case for 10 s) | | T_L | 260 | $^\circ\text{C}$ |
| Gate-to-Source ESD Rating – (Human Body Model, Method 3015) | | ESD | 1800 | V |

THERMAL RESISTANCE RATINGS

| Junction-to-Ambient – Steady State (Note 1) | $R_{\theta JA}$ | Value | $^\circ\text{C}/\text{W}$ |
|---|-----------------|-------|---------------------------|
| SC-75 | | 415 | |
| SC-89 | | 400 | |

Stresses exceeding those listed in the Maximum Ratings table may damage the device. If any of these limits are exceeded, device functionality should not be assumed, damage may occur and reliability may be affected.

1. Surface mounted on FR4 board using 1 in sq pad size (Cu area = 1.127 in sq [1 oz] including traces).



ON Semiconductor®

www.onsemi.com

| $V_{(BR)DSS}$ | $R_{DS(on)}$ TYP | I_D MAX |
|---------------|------------------------|-----------|
| -20 V | 0.26 Ω @ -4.5 V | -760 mA |
| | 0.35 Ω @ -2.5 V | |
| | 0.49 Ω @ -1.8 V | |

P-Channel MOSFET

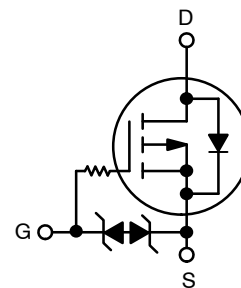

MARKING DIAGRAM & PIN ASSIGNMENT

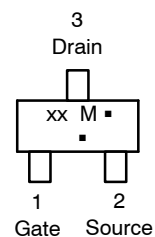
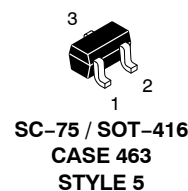

xx = Device Code
M = Date Code*
■ = Pb-Free Package

(Note: Microdot may be in either location)

*Date Code orientation may vary depending upon manufacturing location.

ORDERING INFORMATION

See detailed ordering and shipping information in the package dimensions section on page 2 of this data sheet.

NTA4151P, NTE4151P

ELECTRICAL CHARACTERISTICS (T_J = 25°C unless otherwise stated)

| Parameter | Symbol | Test Condition | Min | Typ | Max | Unit |
|-----------|--------|----------------|-----|-----|-----|------|
|-----------|--------|----------------|-----|-----|-----|------|

OFF CHARACTERISTICS

| | | | | | | |
|-----------------------------------|----------------------|---|-----|------|------|----|
| Drain-to-Source Breakdown Voltage | V _{(BR)DSS} | V _{GS} = 0 V, I _D = -250 μA | -20 | | | V |
| Zero Gate Voltage Drain Current | I _{DSS} | V _{GS} = 0 V, V _{DS} = -16 V | | -1.0 | -100 | nA |
| Gate-to-Source Leakage Current | I _{GSS} | V _{DS} = 0 V, V _{GS} = ±4.5 V | | ±1.0 | ±10 | μA |

ON CHARACTERISTICS (Note 2)

| | | | | | | |
|-------------------------------|---------------------|--|-------|------|------|---|
| Gate Threshold Voltage | V _{GS(TH)} | V _{DS} = V _{GS} , I _D = -250 μA | -0.45 | | -1.2 | V |
| Drain-to-Source On Resistance | R _{DS(on)} | V _{GS} = -4.5 V, I _D = -350 mA | | 0.26 | 0.36 | Ω |
| | | V _{GS} = -2.5 V, I _D = -300 mA | | 0.35 | 0.45 | |
| | | V _{GS} = -1.8 V, I _D = -150 mA | | 0.49 | 1.0 | |
| Forward Transconductance | g _{FS} | V _{DS} = -10 V, I _D = -250 mA | | 0.4 | | S |

CHARGES AND CAPACITANCES

| | | | | | | |
|------------------------------|---------------------|---|--|-------|--|----|
| Input Capacitance | C _{ISS} | V _{GS} = 0 V, f = 1.0 MHz, V _{DS} = -5.0 V | | 156 | | pF |
| Output Capacitance | C _{OSS} | | | 28 | | |
| Reverse Transfer Capacitance | C _{RSS} | | | 18 | | |
| Total Gate Charge | Q _{G(TOT)} | V _{GS} = -4.5 V, V _{DD} = -10 V, I _D = -0.3 A | | 2.1 | | nC |
| Threshold Gate Charge | Q _{G(TH)} | | | 0.125 | | |
| Gate-to-Source Charge | Q _{GS} | | | 0.325 | | |
| Gate-to-Drain Charge | Q _{GD} | | | 0.5 | | |

SWITCHING CHARACTERISTICS (Note 3)

| | | | | | | |
|---------------------|---------------------|---|--|------|--|----|
| Turn-On Delay Time | t _{d(ON)} | V _{GS} = -4.5 V, V _{DD} = -10 V, I _D = -200 mA, R _G = 10 Ω | | 8.0 | | ns |
| Rise Time | t _r | | | 8.2 | | |
| Turn-Off Delay Time | t _{d(OFF)} | | | 29 | | |
| Fall Time | t _f | | | 20.4 | | |

DRAIN-SOURCE DIODE CHARACTERISTICS

| | | | | | | |
|-----------------------|-----------------|---|--|-------|------|---|
| Forward Diode Voltage | V _{SD} | V _{GS} = 0 V, I _S = -250 mA | | -0.72 | -1.1 | V |
|-----------------------|-----------------|---|--|-------|------|---|

Product parametric performance is indicated in the Electrical Characteristics for the listed test conditions, unless otherwise noted. Product performance may not be indicated by the Electrical Characteristics if operated under different conditions.

2. Pulse Test: pulse width ≤ 300 μs, duty cycle ≤ 2%.

3. Switching characteristics are independent of operating junction temperatures.

ORDERING INFORMATION

| Device | Marking | Package | Shipping† |
|-------------|---------|--------------------|--------------------|
| NTA4151PT1G | TN | SC-75 (Pb-Free) | 3000 / Tape & Reel |
| NTE4151PT1G | TM | SC-89 (Pb-Free) | 3000 / Tape & Reel |

†For information on tape and reel specifications, including part orientation and tape sizes, please refer to our Tape and Reel Packaging Specifications Brochure, BRD8011/D.

NTA4151P, NTE4151P

TYPICAL ELECTRICAL CHARACTERISTICS

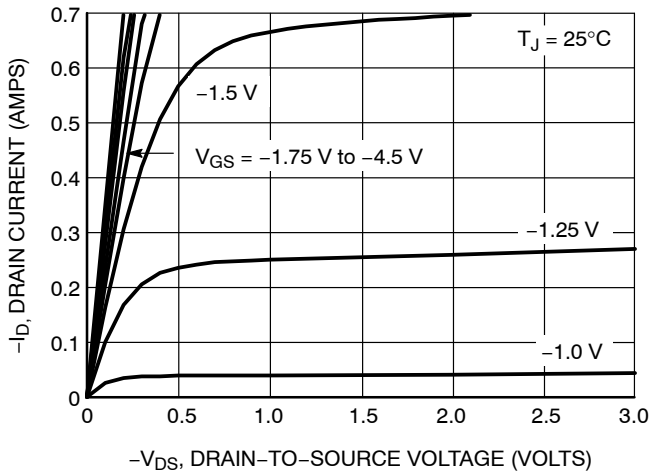

Figure 1. On-Region Characteristics

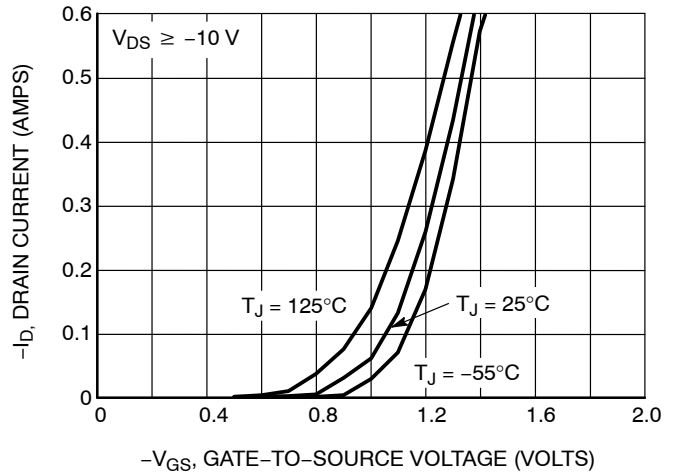

Figure 2. Transfer Characteristics

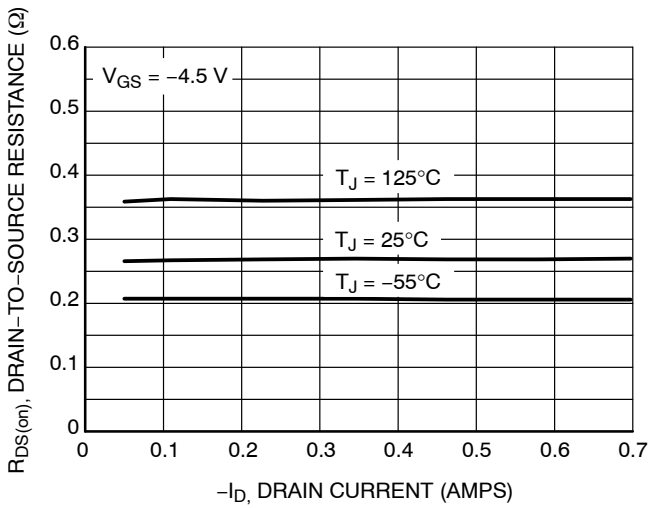

Figure 3. On-Resistance vs. Drain Current and Temperature

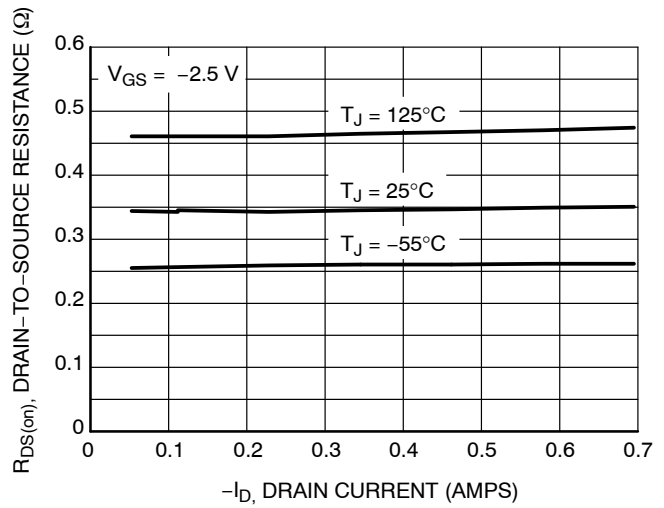

Figure 4. On-Resistance vs. Drain Current and Temperature

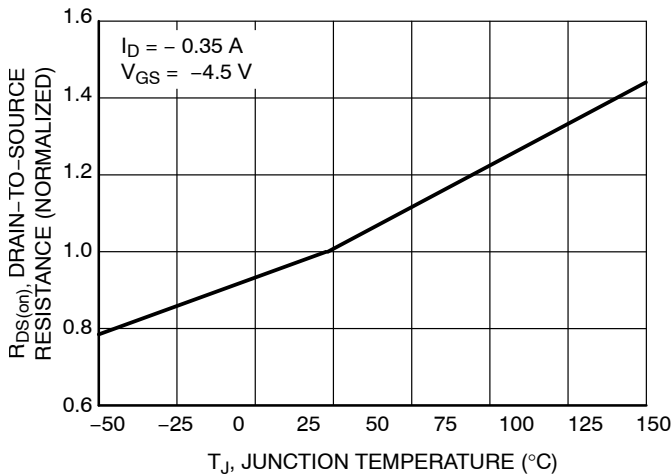

Figure 5. On-Resistance Variation with Temperature

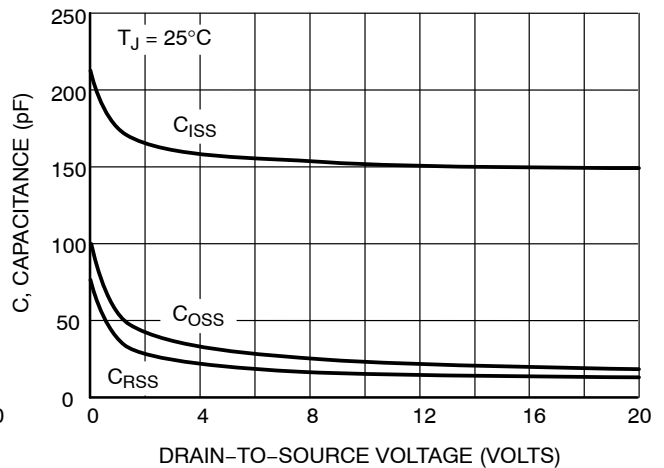

Figure 6. Capacitance Variation

NTA4151P, NTE4151P

TYPICAL ELECTRICAL CHARACTERISTICS

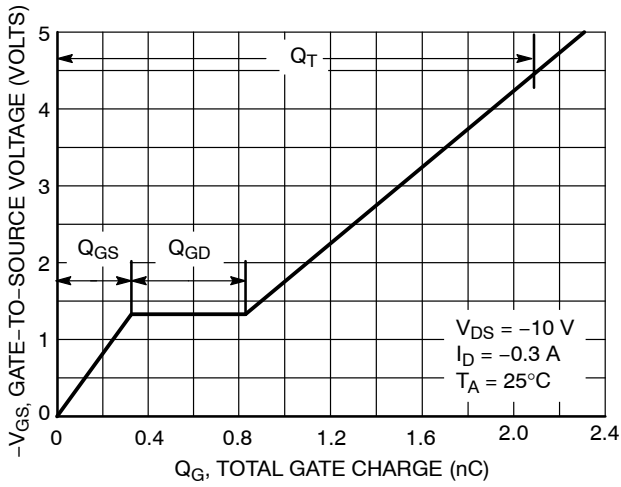

Figure 7. Gate-to-Source Voltage vs. Total Gate Charge

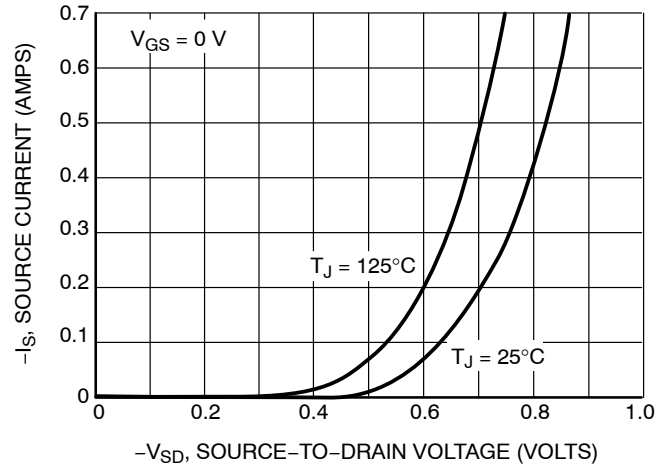

Figure 8. Diode Forward Voltage vs. Current

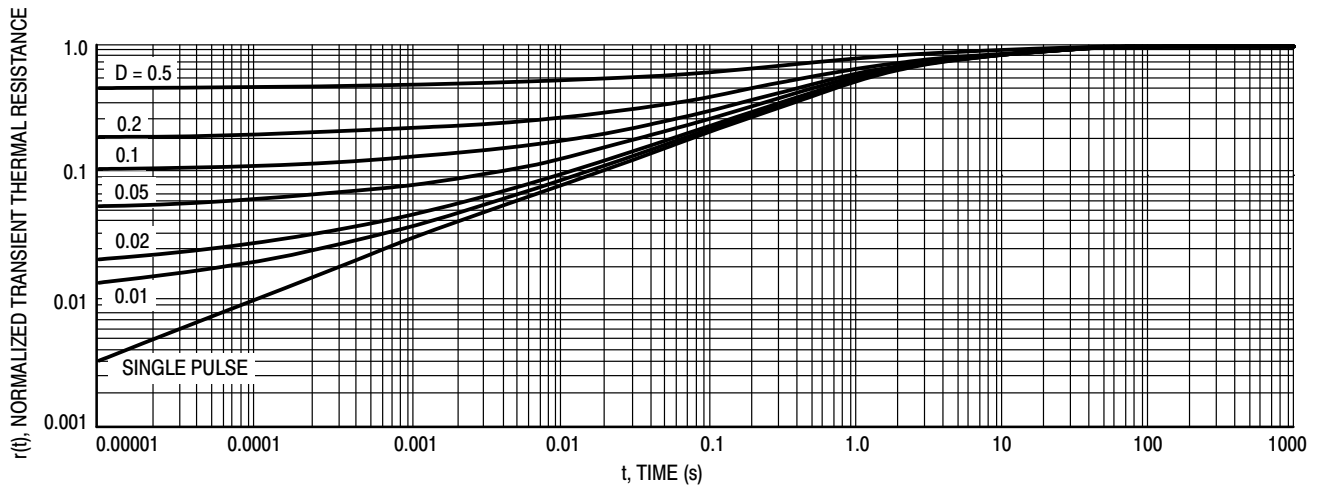

Figure 9. Normalized Thermal Response

MECHANICAL CASE OUTLINE

PACKAGE DIMENSIONS

ON Semiconductor®



SC-75/SOT-416
CASE 463-01
ISSUE G

DATE 07 AUG 2015

SCALE 4:1

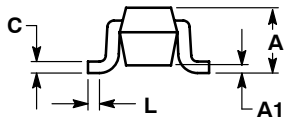

STYLE 1:
PIN 1. BASE
2. EMITTER
3. COLLECTOR

STYLE 2:
PIN 1. ANODE
2. N/C
3. CATHODE

STYLE 3:
PIN 1. ANODE
2. ANODE
3. CATHODE

STYLE 4:
PIN 1. CATHODE
2. CATHODE
3. ANODE

STYLE 5:
PIN 1. GATE
2. SOURCE
3. DRAIN

NOTES:

1. DIMENSIONING AND TOLERANCING PER ANSI Y14.5M, 1982.
2. CONTROLLING DIMENSION: MILLIMETER.

| DIM | MILLIMETERS | | | INCHES | | |
|-----|-------------|------|------|----------|-------|-------|
| | MIN | NOM | MAX | MIN | NOM | MAX |
| A | 0.70 | 0.80 | 0.90 | 0.027 | 0.031 | 0.035 |
| A1 | 0.00 | 0.05 | 0.10 | 0.000 | 0.002 | 0.004 |
| b | 0.15 | 0.20 | 0.30 | 0.006 | 0.008 | 0.012 |
| C | 0.10 | 0.15 | 0.25 | 0.004 | 0.006 | 0.010 |
| D | 1.55 | 1.60 | 1.65 | 0.061 | 0.063 | 0.065 |
| E | 0.70 | 0.80 | 0.90 | 0.027 | 0.031 | 0.035 |
| e | 1.00 BSC | | | 0.04 BSC | | |
| L | 0.10 | 0.15 | 0.20 | 0.004 | 0.006 | 0.008 |
| HE | 1.50 | 1.60 | 1.70 | 0.060 | 0.063 | 0.067 |

GENERIC MARKING DIAGRAM*



- XX = Specific Device Code
- M = Date Code
- = Pb-Free Package

*This information is generic. Please refer to device data sheet for actual part marking. Pb-Free indicator, "G" or microdot "■", may or may not be present.

SOLDERING FOOTPRINT*



SCALE 10:1 (mm/inches)

*For additional information on our Pb-Free strategy and soldering details, please download the ON Semiconductor Soldering and Mounting Techniques Reference Manual, SOLDERRM/D.

| | | |
|-------------------------|----------------------|--|
| DOCUMENT NUMBER: | 98ASB15184C | Electronic versions are uncontrolled except when accessed directly from the Document Repository. Printed versions are uncontrolled except when stamped "CONTROLLED COPY" in red. |
| DESCRIPTION: | SC-75/SOT-416 | PAGE 1 OF 1 |

ON Semiconductor and are trademarks of Semiconductor Components Industries, LLC dba ON Semiconductor or its subsidiaries in the United States and/or other countries. ON Semiconductor reserves the right to make changes without further notice to any products herein. ON Semiconductor makes no warranty, representation or guarantee regarding the suitability of its products for any particular purpose, nor does ON Semiconductor assume any liability arising out of the application or use of any product or circuit, and specifically disclaims any and all liability, including without limitation special, consequential or incidental damages. ON Semiconductor does not convey any license under its patent rights nor the rights of others.

MECHANICAL CASE OUTLINE

PACKAGE DIMENSIONS

ON Semiconductor®



SCALE 4:1

SC-89, 3 LEAD CASE 463C-03 ISSUE C

DATE 31 JUL 2003

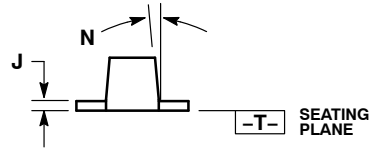
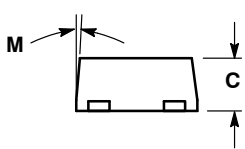
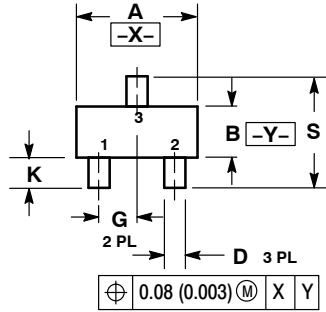

- STYLE 1:
PIN 1. BASE
2. EMITTER
3. COLLECTOR
- STYLE 2:
PIN 1. ANODE
2. N/C
3. CATHODE
- STYLE 3:
PIN 1. ANODE
2. ANODE
3. CATHODE
- STYLE 4:
PIN 1. CATHODE
2. CATHODE
3. ANODE

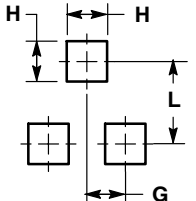

RECOMMENDED PATTERN OF SOLDER PADS

- NOTES:
- DIMENSIONING AND TOLERANCING PER ANSI Y14.5M, 1982.
 - CONTROLLING DIMENSION: MILLIMETERS
 - MAXIMUM LEAD THICKNESS INCLUDES LEAD FINISH THICKNESS. MINIMUM LEAD THICKNESS IS THE MINIMUM THICKNESS OF BASE MATERIAL.
 - 463C-01 OBSOLETE, NEW STANDARD 463C-02.

| DIM | MILLIMETERS | | | INCHES | | |
|-----|-------------|------|------|-----------|-------|-------|
| | MIN | NOM | MAX | MIN | NOM | MAX |
| A | 1.50 | 1.60 | 1.70 | 0.059 | 0.063 | 0.067 |
| B | 0.75 | 0.85 | 0.95 | 0.030 | 0.034 | 0.040 |
| C | 0.60 | 0.70 | 0.80 | 0.024 | 0.028 | 0.031 |
| D | 0.23 | 0.28 | 0.33 | 0.009 | 0.011 | 0.013 |
| G | 0.50 BSC | | | 0.020 BSC | | |
| H | 0.53 REF | | | 0.021 REF | | |
| J | 0.10 | 0.15 | 0.20 | 0.004 | 0.006 | 0.008 |
| K | 0.30 | 0.40 | 0.50 | 0.012 | 0.016 | 0.020 |
| L | 1.10 REF | | | 0.043 REF | | |
| M | --- | --- | 10 | --- | --- | 10 |
| N | --- | --- | 10 | --- | --- | 10 |
| S | 1.50 | 1.60 | 1.70 | 0.059 | 0.063 | 0.067 |

GENERIC MARKING DIAGRAM*

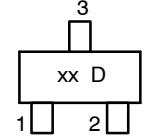

xx = Specific Device Code
D = Date Code

*This information is generic. Please refer to device data sheet for actual part marking.

| | | |
|------------------|---------------|--|
| DOCUMENT NUMBER: | 98AON11472D | Electronic versions are uncontrolled except when accessed directly from the Document Repository. Printed versions are uncontrolled except when stamped "CONTROLLED COPY" in red. |
| DESCRIPTION: | SC-89, 3 LEAD | PAGE 1 OF 1 |

ON Semiconductor and are trademarks of Semiconductor Components Industries, LLC dba ON Semiconductor or its subsidiaries in the United States and/or other countries. ON Semiconductor reserves the right to make changes without further notice to any products herein. ON Semiconductor makes no warranty, representation or guarantee regarding the suitability of its products for any particular purpose, nor does ON Semiconductor assume any liability arising out of the application or use of any product or circuit, and specifically disclaims any and all liability, including without limitation special, consequential or incidental damages. ON Semiconductor does not convey any license under its patent rights nor the rights of others.

onsemi, **Onsemi**, and other names, marks, and brands are registered and/or common law trademarks of Semiconductor Components Industries, LLC dba "**onsemi**" or its affiliates and/or subsidiaries in the United States and/or other countries. **onsemi** owns the rights to a number of patents, trademarks, copyrights, trade secrets, and other intellectual property. A listing of **onsemi**'s product/patent coverage may be accessed at www.onsemi.com/site/pdf/Patent-Marking.pdf. **onsemi** reserves the right to make changes at any time to any products or information herein, without notice. The information herein is provided "as-is" and **onsemi** makes no warranty, representation or guarantee regarding the accuracy of the information, product features, availability, functionality, or suitability of its products for any particular purpose, nor does **onsemi** assume any liability arising out of the application or use of any product or circuit, and specifically disclaims any and all liability, including without limitation special, consequential or incidental damages. Buyer is responsible for its products and applications using **onsemi** products, including compliance with all laws, regulations and safety requirements or standards, regardless of any support or applications information provided by **onsemi**. "Typical" parameters which may be provided in **onsemi** data sheets and/or specifications can and do vary in different applications and actual performance may vary over time. All operating parameters, including "Typicals" must be validated for each customer application by customer's technical experts. **onsemi** does not convey any license under any of its intellectual property rights nor the rights of others. **onsemi** products are not designed, intended, or authorized for use as a critical component in life support systems or any FDA Class 3 medical devices or medical devices with a same or similar classification in a foreign jurisdiction or any devices intended for implantation in the human body. Should Buyer purchase or use **onsemi** products for any such unintended or unauthorized application, Buyer shall indemnify and hold **onsemi** and its officers, employees, subsidiaries, affiliates, and distributors harmless against all claims, costs, damages, and expenses, and reasonable attorney fees arising out of, directly or indirectly, any claim of personal injury or death associated with such unintended or unauthorized use, even if such claim alleges that **onsemi** was negligent regarding the design or manufacture of the part. **onsemi** is an Equal Opportunity/Affirmative Action Employer. This literature is subject to all applicable copyright laws and is not for resale in any manner.

PUBLICATION ORDERING INFORMATION

LITERATURE FULFILLMENT:

Email Requests to: orderlit@onsemi.com

onsemi Website: www.onsemi.com

TECHNICAL SUPPORT

North American Technical Support:

Voice Mail: 1 800-282-9855 Toll Free USA/Canada

Phone: 011 421 33 790 2910

Europe, Middle East and Africa Technical Support:

Phone: 00421 33 790 2910

For additional information, please contact your local Sales Representative