

## Evaluates: MAX77831

## MAX77831 Evaluation Kit

### General Description

The MAX77831 evaluation kit (EV kit) provides a proven design to evaluate the MAX77831, a 7A switching current, high-efficiency, high-performance buck-boost regulator that only operates in forced-PWM (FPWM) mode. The IC is capable of 2.5V to 16V input and dynamically adjustable output between 4.5V to 15V when using internal feedback resistors, or between 3V to 15V when using external feedback resistors. The EV kit is factory-configured as internal feedback with the default startup output voltage at 5V. Other startup voltage can be achieved with external feedback resistors. Output voltage can be adjusted dynamically through the I<sup>2</sup>C serial interface.

The I/O pins are available to support the I<sup>2</sup>C serial interface, Enable function, and Interrupt/Power-OK indicator. The I<sup>2</sup>C slave address, switching current limit, and feedback configuration can be adjusted by changing the R<sub>SEL</sub> resistor value (R9). The MAXUSB\_INTERFACE# allows the use of Windows®-based software with a friendly graphical user interface (GUI) as well as a detailed register-based interface to exercise all the features of the IC. The IC installed on the EV kit is the MAX77831BEWB+T.

### Benefits and Features

- Proven PCB Reference Design and Layout Benefit
- Fully Assembled and Tested
- Sense Points for High-Accuracy Measurements
- Accessible Test Point Pins for EN, POKB/INTB, V<sub>IO</sub>, and the I<sup>2</sup>C Serial Interface SCL, SDA
- MAXUSB\_INTERFACE# Allows Easy Communication with a Windows PC
- GUI Software that Drives the I<sup>2</sup>C Serial Interface for Optional Software Control
- Startup Output Voltage Adjustable Through External Feedback Resistors
- Output Voltage Dynamically Adjustable Through the I<sup>2</sup>C Serial Interface
- I<sup>2</sup>C Slave Address, Switching Current Limit, and Feedback Configuration Adjustable Using R<sub>SEL</sub> (R9)

**Ordering Information appears at end of data sheet.**

### MAX77831 EV Kit Specifications

SPECIFICATION	TEST CONDITION	MIN	TYP	MAX	UNIT
Input Voltage		2.5		16	V
Output Voltage	Internal Feedback	4.5		15	V
	External Feedback	3		15	V
Default Output Voltage	Internal Feedback		5		V
Switching Current Limit			7		A
Peak Efficiency	V <sub>IN</sub> = 4V, V <sub>OUT</sub> = 5V, 700mA Load		97.0		%

Windows is a registered trademark of Microsoft Corp.

319-100600; Rev 1; 9/21

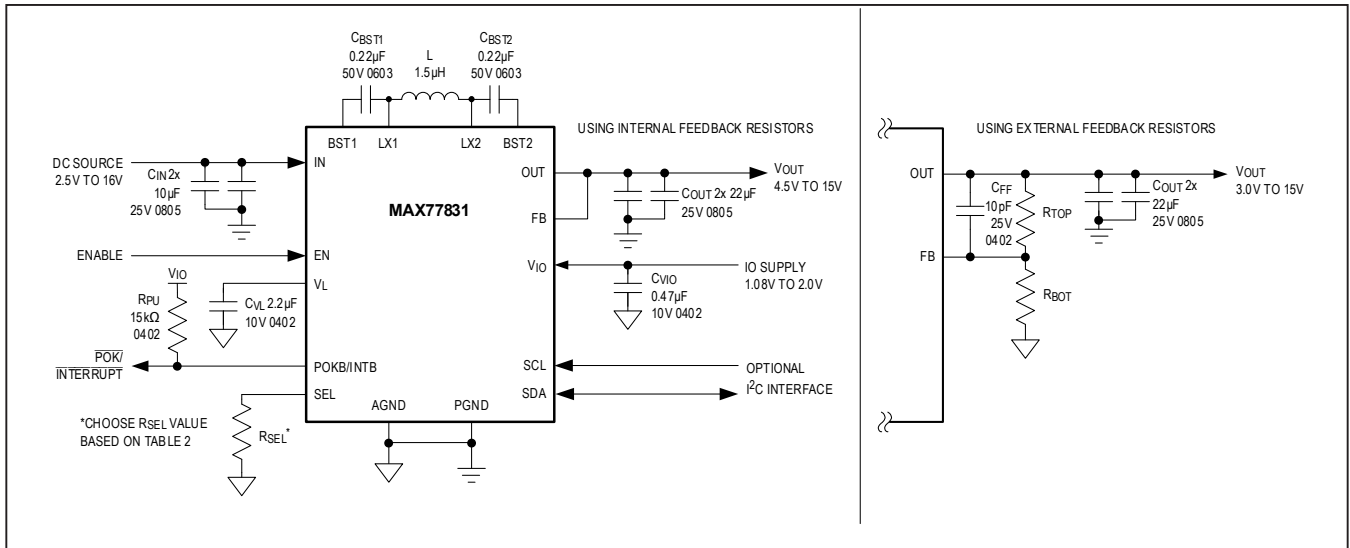

Figure 1. Application Circuit for MAX77831

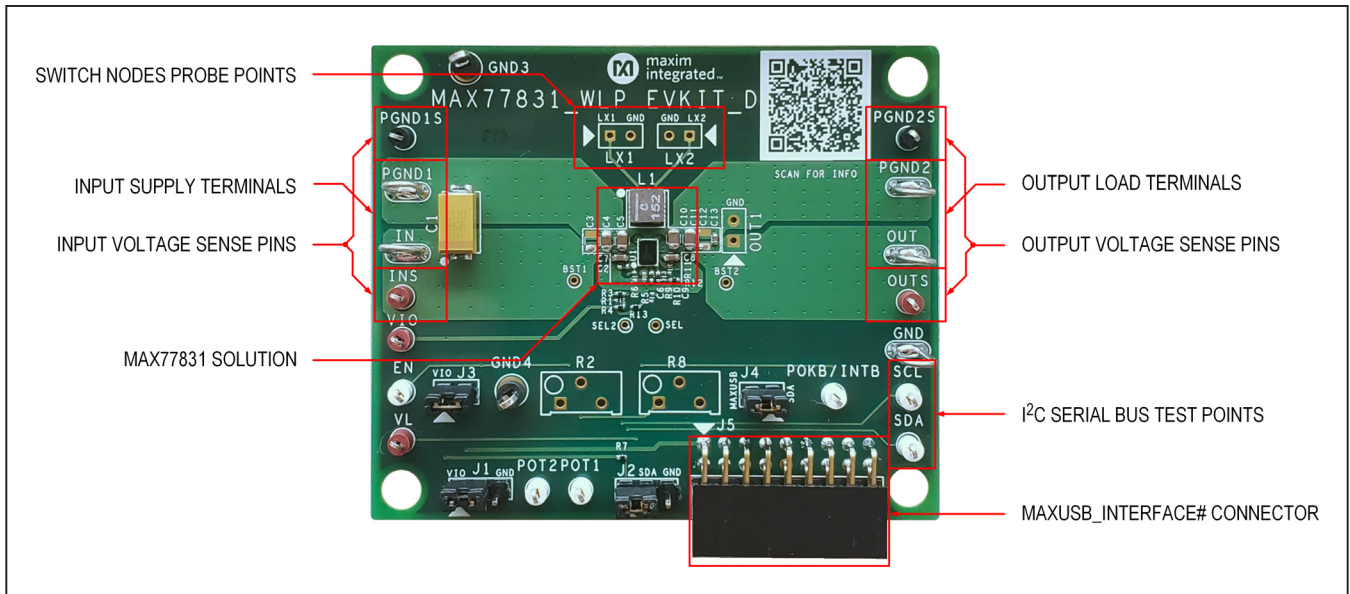

Figure 2. MAX77831 EV Kit Photo

## EV Kit Default Configuration

With the default jumper settings listed in [Table 1](#) and the EV kit component values of  $R_{SEL}$  (R9) =  $0\Omega$ ,  $R_{TOP}$  (R10) =  $0\Omega$ , and  $R_{BOT}$  (R11) = OPEN, the MAX77831 EV kit is configured with the following settings:

- Internal Feedback
- Switching Current Limit = 7.0A
- I<sup>2</sup>C Slave Address (7-bit) = 0x66
- Switching Frequency = 1.8MHz (adjustable only through the I<sup>2</sup>C)
- I<sup>2</sup>C Line Connected to MAXUSB\_INTERFACE#

See the [EV Kit Hardware](#) section to change the EV kit configuration.

## Quick Start

### Required Equipment

- MAX77831 EV Kit
- Adjustable DC Power Supply
- A 1.8V DC Power Supply
- Digital Multi-Meters
- Electronic Load
- MAXUSB\_INTERFACE# for I<sup>2</sup>C Serial Interface (Optional)
- USB Type-A to Micro-USB Cable (Optional)
- Windows-based PC with MAX77831 EV Kit GUI (Optional)

### Procedure

The EV kit is fully assembled and tested. Perform the following steps to verify board operation. Use twisted wires of appropriate gauge (20 AWG) that are as short as possible to connect the load and power sources.

- 1) Ensure that the EV kit has the correct jumper settings, as shown in [Table 1](#).
- 2) Connect a DVM to the INS and PGND1S sense pins to measure input voltage.
- 3) Connect a DVM to the OUTS and PGND2S sense pins to measure output voltage.
- 4) Apply a power supply set to 1.8V (100mA current limit) across VIO and GND terminals of the EV kit. Turn on the power supply.
- 5) Apply a power supply set to 0V (1.5A current limit) through an ammeter across the IN and PGND1 terminals of the EV kit. Turn the supply on and increase the voltage to 7.6V.
- 6) Confirm the DVM connected to OUTS and PGND2S reads the default output voltage of the EV kit (5V). Confirm the ammeter reads the expected input supply current (about 12mA).
- 7) Now that the EV kit is confirmed working, short out the series ammeter and increase the current limit on the power supply connected across IN and PGND1. Connect an electronic load across the OUT and PGND2 terminals to evaluate the performance of the MAX77831 buck-boost regulator.

The next steps of the procedure use the EV kit GUI and MAXUSB\_INTERFACE# to evaluate the MAX77831's I<sup>2</sup>C serial interface. If evaluation of the I<sup>2</sup>C serial interface is not required, you may skip the following steps. The EV kit includes on-board 2.2k $\Omega$  pullup resistors (R4 and R7) to VIO.

- 8) Install GUI software. Visit the product webpage at <https://www.maximintegrated.com/products/MAX77831WEVKIT> and navigate to Design Resources to download the latest version of the EV kit software. Save the EV kit software installation file to a temporary folder and decompress the ZIP file. Run the .EXE file and follow the on-screen instructions to complete installation.

**Table 1. Default Shunt Positions and Jumper Description**

JUMPER	NODE	SHUNT POSITION	FUNCTION
J1	EN	1-2*	Connects EN to VIO (logic-high, enables MAX77831).
		2-3	Connects EN to AGND (logic-low, disables MAX77831).
J2	SDA	1-2*	Pulls SDA up to VIO through R7 (2.2k $\Omega$ ).
		2-3	Connects SDA to AGND.
J3	MAXUSB_VIO	1-2*	Connects MAXUSB_INTERFACE# VIO to EV kit VIO.
J4	MAXUSB_SDA	1-2*	Connects MAXUSB_INTERFACE# SDA to EV kit SDA.
R3	MAXUSB_SCL	0 $\Omega$ installed*	Connects MAXUSB_INTERFACE# SCL to EV kit SCL.

\*Default position

- 9) Turn off the 1.8V  $V_{IO}$  power supply and input power supply connected in step 4 and step 5.
- 10) Disconnect the 1.8V  $V_{IO}$  power supply connected in step 4 from the EV kit. The MAXUSB\_INTERFACE# has an on-board LDO to supply 1.8V to  $V_{IO}$ .
- 11) Ensure the SW1 and SW2 switches on the MAXUSB\_INTERFACE# are set to the ON position. This enables I<sup>2</sup>C mode on the MAXUSB\_INTERFACE#.
- 12) **Important:** Ensure the VL Jumper on the MAXUSB\_INTERFACE# (J5) is set to 1.8V. This sets the MAXUSB\_INTERFACE#  $V_{IO}$  voltage. Setting this incorrectly to 3.3V could potentially damage the MAX77831 IC.
- 13) Connect the MAXUSB\_INTERFACE# to the MAX77831 EV kit. Connect the MAXUSB\_INTERFACE# to your PC's USB port using a USB Type-A to Micro-USB Cable.
- 14) Turn on the input power supply.
- 15) Open the GUI and click the **Device** button in the menu bar. Click the **Connect** button in the **Device** button's drop-down list. Wait for the device to respond, and in the **Synchronize** window, press the **Connect and Read** button.
- 16) Drag the slide bar in the [Output Voltage Configuration](#) section to change the output voltage and click Write.
- 17) Confirm with a DVM that the software instruction to change output voltage was successful. If so, the I<sup>2</sup>C serial interface is confirmed as working.

This concludes the Quick Start procedure. Users are now encouraged to further explore the device and its register settings with the GUI software. For more information on the GUI, see the [EV Kit Software](#) section.

## EV Kit Hardware

The MAX77831 EV kit demonstrates the MAX77831 buck-boost regulator. It regulates output from input voltage ranges from 2.5V to 16V. The programmable output range is from 4.5V to 15V with internal feedback resistors, or from 3V to 15V with external feedback resistors. The EV kit is suited with a general DC input. [Table 1](#) lists jumpers and associated functions that are available on the EV kit.

## R<sub>SEL</sub> Configuration Resistor

The MAX77831 includes an SEL pin to set the I<sup>2</sup>C slave address, switching current limit, and feedback configuration. A resistor with a tolerance of 1% (or better) should be chosen for R<sub>9</sub>, which is the SEL pin configuration resistor R<sub>SEL</sub>. The default R<sub>SEL</sub> value installed on the EV kit is 0Ω. See [Table 2](#) for the nominal R<sub>SEL</sub> values and their corresponding settings. The switching current limit is also adjustable dynamically through the I<sup>2</sup>C serial interface

when the MAX77831 is enabled. See the [EV Kit Software](#) section for more information.

## Output Voltage Configuration

By default, the EV kit is configured to use internal feedback resistors, with 5V default startup output voltage and an output voltage range from 4.5V to 15V. To achieve a different default startup output voltage other than 5V, or to achieve a lower minimum output voltage range down to 3V, external feedback resistors are required. To change the EV kit to the external feedback configuration, replace the feedback resistors R<sub>TOP</sub> (R10) and R<sub>BOT</sub> (R11) with appropriate value resistors (use resistors with 1% tolerance or better) and adjust R<sub>SEL</sub> (R9) accordingly to select the external feedback option. It is also recommended to install a 10pF feed-forward capacitor on C9 when using external feedback.

To select appropriate external feedback resistor values, first choose R<sub>TOP</sub> (R10) to be between 150kΩ and 330kΩ. Then calculate the value of R<sub>BOT</sub> (R11) for a desired startup output voltage with the following equation:

$$V_{OUT} = \frac{R_{BOT} \times V_{REF}}{V_{OUT} - V_{REF}}$$

where V<sub>REF</sub> is 0.333V and V<sub>OUT</sub> is the desired startup output voltage. Note that the output voltage cannot exceed the maximum output voltage 15V. The recommended external feedback resistor values for common output voltage are listed in [Table 3](#).

After startup, the output voltage can be adjusted dynamically using the I<sup>2</sup>C serial interface. See the [EV Kit Software](#) section for more information. When using internal feedback, output voltage ranges between 4.5V and 15V in 73.5mV steps. When using external feedback, output voltage range and step size vary based on the external feedback resistor values. To calculate output voltage range, use the following equation and plug in the minimum V<sub>REF</sub> of 0.299V and maximum V<sub>REF</sub> of 1V:

$$V_{OUT} = \frac{V_{REF}}{R_{BOT}} \times (R_{BOT} + R_{TOP})$$

Output voltage step size can be calculated with the following equation:

$$V_{OUT\_STEP} = \frac{4.9mV}{R_{BOT}} \times (R_{BOT} + R_{TOP})$$

Programmable output voltage ranges and output voltage step sizes for each recommended external feedback resistor pairs are listed in [Table 3](#).

**Table 2. MAX77831 R<sub>SEL</sub> Selection Table**

R <sub>SEL</sub> (Ω)	FEEDBACK RESISTOR SELECTION	TYPICAL I <sub>LIM</sub> (A)	I <sup>2</sup> C SLAVE ADDRESS (7-BIT)	R <sub>SEL</sub> (Ω)	FEEDBACK RESISTOR SELECTION	TYPICAL I <sub>LIM</sub> (A)	I <sup>2</sup> C SLAVE ADDRESS (7-BIT)
0*	Internal Feedback Resistors	7.0	110 0110 (0x66)	3740	External Feedback Resistors	7.0	110 0110 (0x66)
200			110 0111 (0x67)	8060			110 0111 (0x67)
309			110 1110 (0x6E)	12400			110 1110 (0x6E)
422			110 1111 (0x6F)	16900			110 1111 (0x6F)
536		5.6	110 0110 (0x66)	21500		5.6	110 0110 (0x66)
649			110 0111 (0x67)	26100			110 0111 (0x67)
768			110 1110 (0x6E)	30900			110 1110 (0x6E)
909			110 1111 (0x6F)	36500			110 1111 (0x6F)
1050		3.8	110 0110 (0x66)	42200		3.8	110 0110 (0x66)
1210			110 0111 (0x67)	48700			110 0111 (0x67)
1400			110 1110 (0x6E)	56200			110 1110 (0x6E)
1620			110 1111 (0x6F)	64900			110 1111 (0x6F)
1870		1.72	110 0110 (0x66)	75000		1.72	110 0110 (0x66)
2150			110 0111 (0x67)	86600			110 0111 (0x67)
2490			110 1110 (0x6E)	100000			110 1110 (0x6E)
2870			110 1111 (0x6F)	OPEN			110 1111 (0x6F)

\*Default value installed on the EV kit

**Table 3. Feedback Resistor Value Recommendations**

DEFAULT V <sub>REF</sub> (V)	R <sub>TOP</sub> R10 (kΩ)	R <sub>BOT</sub> R11 (kΩ)	STARTUP V <sub>OUT</sub> (V)	PROGRAMMABLE V <sub>OUT</sub> RANGE (V)	V <sub>OUT</sub> STEP SIZE (mV)
0.333	160	20	3	3.0 to 9.0	44.1
	178	20	3.3	3.0 to 9.9	48.5
	Internal Feedback Resistors		5	4.5 to 15	73.5
	312	12	9	8.1 to 15	132.3
	232	6.65	12	10.7 to 15	175.8
	234	5.3	15	13.5 to 15	221.2

**MAXUSB\_INTERFACE#**

The MAXUSB\_INTERFACE# along with the companion EV kit GUI software allows users to easily change the MAX77831’s register settings with a Windows PC. Before connecting the MAXUSB\_INTERFACE# to the EV kit’s MAXUSB\_INTERFACE# connector (J5), make sure the MAXUSB\_INTERFACE# is configured with the following settings:

- SW1, SW2 to ON Position (This enables I<sup>2</sup>C mode on the MAXUSB\_INTERFACE#.)

- VL Jumper (J5) to 1.8V (This sets the MAXUSB\_INTERFACE# VIO voltage.)
  - **Warning:** Setting this incorrectly to 3.3V could potentially damage the MAX77831 IC.

The MAXUSB\_INTERFACE# also includes an on-board LDO that can supply necessary voltage to V<sub>IO</sub>. If you are using the MAXUSB\_INTERFACE#, disconnect any external V<sub>IO</sub> supply from the EV kit, and make sure header jumpers J3, J4, and 0Ω jumper R3 are installed to connect the MAXUSB\_INTERFACE# to the EV kit.



**External I<sup>2</sup>C Bus**

To connect to the external I<sup>2</sup>C serial bus and not use the MAXUSB\_INTERFACE#, unplug the MAXUSB\_INTERFACE# from the MAX77831 EV kit's MAXUSB\_INTERFACE# connector (J5), and remove header jumpers J3, J4, and 0Ω jumper R3 to isolate the MAXUSB\_INTERFACE# connector from the EV kit. Apply an external I/O supply to V<sub>IO</sub> pin. Make sure the external I<sup>2</sup>C serial bus's logic voltage level is compatible to the MAX77831's I/O logic voltage level. Refer to the MAX77831 IC data sheet for the appropriate I/O logic voltage level.

**High Temperature Testing**

The MAX77831 is rated for operation under junction temperatures up to +125°C. Note that not all components on the EV kit are rated for temperatures this high. Some ceramic capacitors experience extra leakage when put under temperatures higher than they are rated for, and supply current readings for the IC might be larger than expected. The MAXUSB\_INTERFACE# is also not rated for +125°C. Double check the components on the EV kit if testing at +125°C ambient or junction temperatures. Consider replacing these components if IC operation at +125°C ambient or junction temperature is an important use case.

List of capacitors not rated for +125°C:

- C10, C11 (OUT capacitors)

**Critical Node Measurement (OUT and LX)**

The EV kit comes with probe points for measuring critical nodes OUT1, LX1, and LX2. See [Figure 2](#) for their locations on the EV kit. Use these probe points to eliminate as much noise as possible when measuring the critical nodes. To ensure best results, use a very short ground wire from the ground sleeve of the scope probe to the GND side of the probe point, and use the bare tip of the probe directly to the signal side of the probe point ([Figure 3](#)).

Following these guidelines gives the most accurate results when measuring parameters such as output voltage ripple, switching waveforms, and load transient response.

**Efficiency Measurement (INS, OUTS)**

The EV kit also comes with sense pins for accurately measuring input voltage (INS, PGND1S) and output voltage (OUTS, PGND2S). See [Figure 2](#) for their locations on the EV kit. For most accurate efficiency, load regulation, and line regulation measurements, use these sense pins to measure input and output voltages.

**Warning:** These sense pins are only for measuring voltages. Do not connect input supply to input sense pins and do not connect electronic load to output sense pins, as these sense pins are not designed to have current running through them. Doing so damages the EV kit.

Use input supply terminals for connecting to input supply and use output terminals for connecting to electronic load as shown in [Figure 2](#).

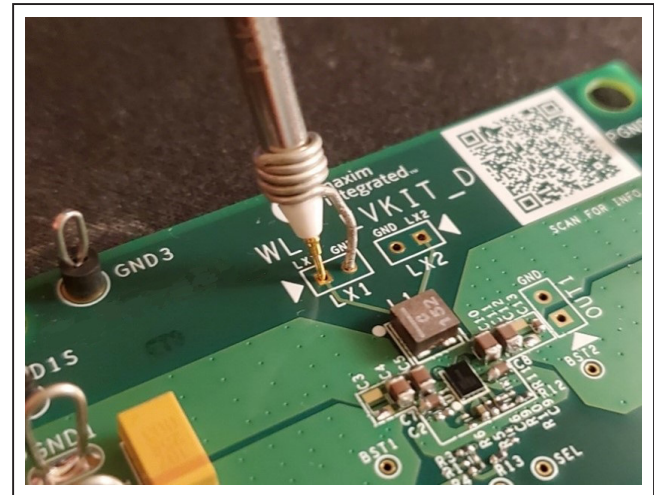

Figure 3. Probing Critical Nodes

**Table 4. Usage of Critical Test Points**

LOAD TRANSIENT, OUTPUT RIPPLE	LOAD REGULATION, LINE REGULATION, V <sub>OUT</sub> ACCURACY	EFFICIENCY		SWITCHING NODE	
		OUTPUT VOLTAGE	INPUT VOLTAGE	LX1	LX2
V <sub>OUT</sub> (OUT1)	V <sub>OUT</sub> (OUTS, PGND2S)	V <sub>OUT</sub> (OUTS, PGND2S)	V <sub>IN</sub> (INS, PGND1S)	LX1 (LX1)	LX2 (LX2)

### EV Kit Software

The graphical user interface (GUI) software allows for quick, easy, and thorough evaluation of the MAX77831. The GUI along with the MAXUSB\_INTERFACE# drives I<sup>2</sup>C communication with the EV kit. Every control in the GUI corresponds directly to a register within MAX77831. Refer to [Register Map](#) section of the MAX77831 IC data sheet for a complete description of the registers. See [Figure 4](#) for a screenshot of the GUI upon first opening.

### Installation

Visit the product webpage at <https://www.maximintegrated.com/products/MAX77831WEVKIT> and navigate to Design Resources to download the latest version of the EV kit software. Save the EV kit software installation file to a temporary folder and decompress the ZIP file. Run the .EXE installer and follow the on-screen instructions to complete the installation.

### Windows Driver

After plugging in the MAXUSB\_INTERFACE# to the PC with a Micro-USB cable for the first time, wait about 30 seconds for Windows to automatically install the necessary drivers.

### Connecting GUI to MAXUSB\_INTERFACE#

After opening the GUI, click **Device** in the upper left corner of the GUI window. Click **Connect** in the drop-down menu.

If you have multiple MAXUSB\_INTERFACE# adapters or FTDI devices connected to your PC, the **Port Synchronization** menu appears ([Figure 5](#)). Select the port corresponding to the MAXUSB\_INTERFACE# attached to the MAX77831 EV kit and click **Connect**.

The **Device Synchronization** menu opens ([Figure 6](#)) once the MAX77831 IC responds (voltages on IN pin and V<sub>IO</sub> pin must be valid on the MAX77831 IC for it to respond). The I<sup>2</sup>C address shown is the MAX77831 IC's 7-bit slave address. The address shown changes depending on the EV kit's R<sub>SEL</sub> configuration. See the EV Kit Hardware [RSEL Configuration Resistor](#) section if you wish to change the address. Click **Connect and Read**. The text at the bottom right of the GUI window changes from "MAXUSB is Disconnected" to "MAXUSB is Connected."

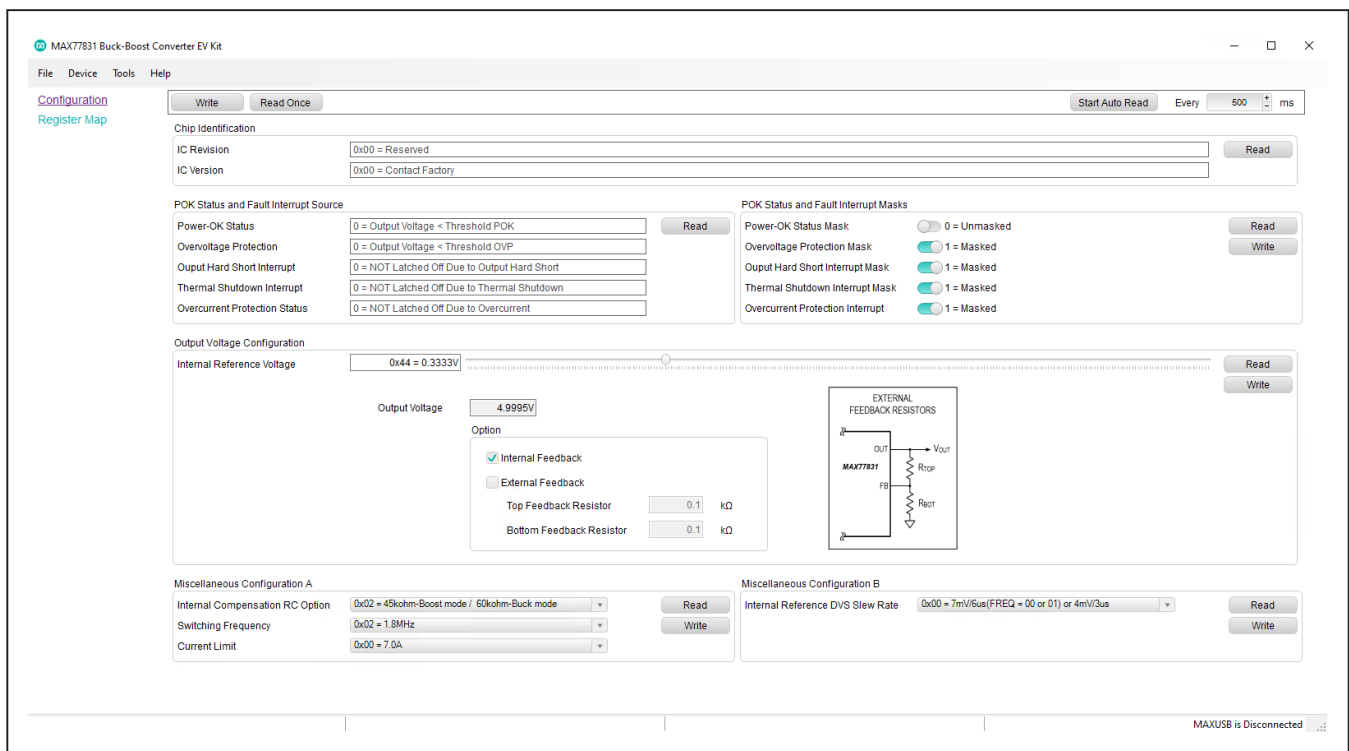

Figure 4. MAX77831 EV Kit GUI Software Configuration Tab

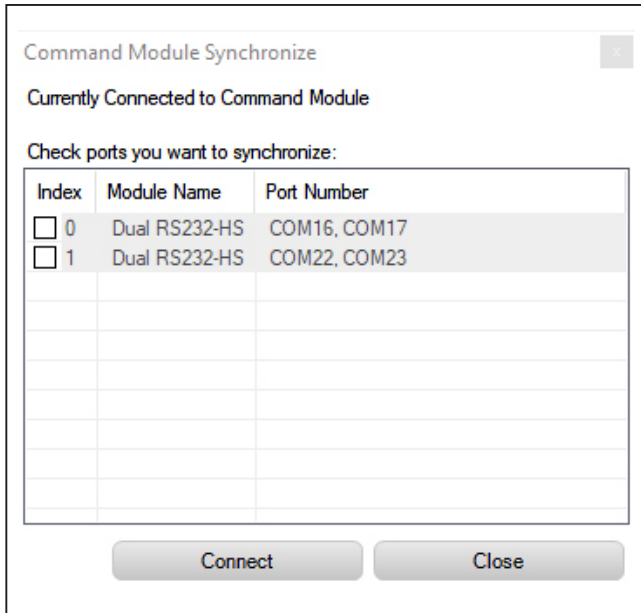

Figure 5. Port Synchronization Menu

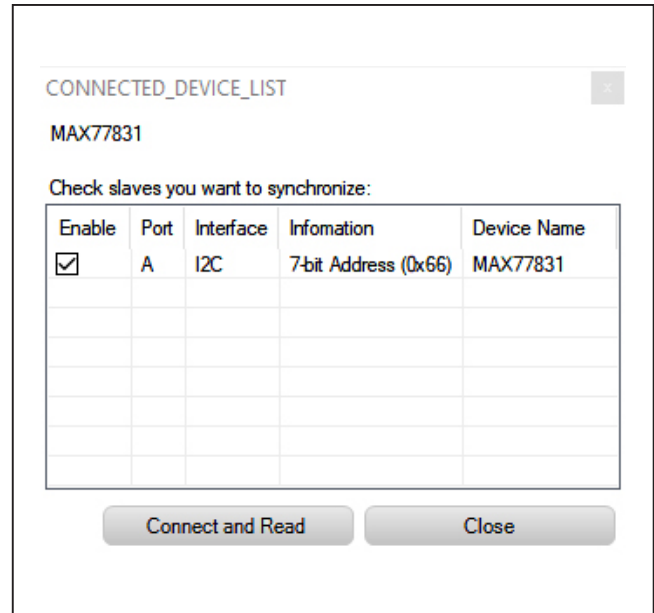

Figure 6. Device Synchronization Menu

### Configuration

The Configuration tab (Figure 4) displays information and status of the IC on the EV Kit as well as all available register settings. It is divided into different sections: Chip Identification, POK Status and Fault Interrupts, Output Voltage Configuration, and Miscellaneous Configuration.

Click **Read Once** located on the top of the GUI window to obtain all setting values currently stored on all the MAX77831’s registers. After changing the setting values in the GUI software, click **Write** on the top of the GUI window to apply all settings to the MAX77831’s registers. Alternatively, click **Read** on each setting section to obtain the setting values of that particular section currently stored on the MAX77831’s registers. After changing the setting values in the GUI software, click **Write** in the corresponding setting section to apply the new settings for that particular section to the MAX77831’s registers.

The Chip Identification section (Figure 7) displays the revision and version information of the MAX77831 IC on the EV Kit. Click **Read** to obtain information from the IC.

The POK Status and Fault Interrupt Source section (Figure 8) displays the power-OK status and any fault conditions detected on the MAX77831 IC, which are stored in the INT\_SRC register. Periodically check the POK Status and Fault Interrupt Source section during evaluation to monitor the status of power-OK (POK), overvoltage protection (OVP), output hard-short, thermal shutdown (THS), and overcurrent protection (OCP). Click **Read** to obtain the latest status from the IC.

The POK Status and Fault Interrupt Masks section (Figure 9) configures the reflection of the bits in INT\_SRC to the POKB/INTB pin. If a bit is masked, its status in the INT\_SRC register is not shown on the POKB/INTB pin. Refer to the Power-OK Monitor and Fault Interrupts section in the IC datasheet for more information about the operation of the POKB/INTB pin. Click **Read** to obtain the setting stored on the IC and click **Write** to apply new settings to the IC.



Chip Identification

IC Revision	<input type="text" value="0x00 = Reserved"/>	<input type="button" value="Read"/>
IC Version	<input type="text" value="0x00 = Contact Factory"/>	

Figure 7. Configuration Tab - Chip Identification Section

POK Status and Fault Interrupt Source

Power-OK Status	<input type="text" value="0 = Output Voltage &lt; Threshold POK"/>	<input type="button" value="Read"/>
Overvoltage Protection	<input type="text" value="0 = Output Voltage &lt; Threshold OVP"/>	
Output Hard Short Interrupt	<input type="text" value="0 = NOT Latched Off Due to Output Hard Short"/>	
Thermal Shutdown Interrupt	<input type="text" value="0 = NOT Latched Off Due to Thermal Shutdown"/>	
Overcurrent Protection Status	<input type="text" value="0 = NOT Latched Off Due to Overcurrent"/>	

Figure 8. Configuration Tab - POK Status and Fault Interrupt Source Section

POK Status and Fault Interrupt Masks

Power-OK Status Mask	<input type="checkbox"/> 0 = Unmasked	<input type="button" value="Read"/> <input type="button" value="Write"/>
Overvoltage Protection Mask	<input checked="" type="checkbox"/> 1 = Masked	
Output Hard Short Interrupt Mask	<input checked="" type="checkbox"/> 1 = Masked	
Thermal Shutdown Interrupt Mask	<input checked="" type="checkbox"/> 1 = Masked	
Overcurrent Protection Interrupt	<input checked="" type="checkbox"/> 1 = Masked	

Figure 9. Configuration Tab - POK Status and Fault Interrupt Masks Section

The [Output Voltage Configuration](#) section ([Figure 10](#)) configures the EV kit IC’s output voltage. The output voltage is changed by adjusting the internal reference voltage. Drag the slider to the desired internal reference voltage (or output voltage) and click **Write** to change the output voltage. Clicking **Read** returns the programmed internal reference voltage (or output voltage) to the GUI.

To make evaluation easier, the GUI software displays the corresponding output voltage value in the **Output Voltage** textbox based on the value in the Internal Reference Voltage slider. To obtain the correct value, check the **Internal Feedback** or **External Feedback** checkbox corresponding to the EV kit configuration. For external feedback configuration, enter the chosen feedback resistor values in the **Top Feedback Resistor** and **Bottom Feedback Resistor** textboxes to allow correct calculation of the corresponding output voltage to be displayed on the GUI software.

**Note:** Changing the Internal Feedback or External Feedback checkboxes ([Figure 10](#)) does NOT change the feedback configuration on the EV kit. It is only for calculating and displaying the correct output voltage value on the GUI software. If you wish to change the EV kit’s feedback configuration, see the EV Kit Hardware [Output Voltage Configuration](#) section for details.

The Miscellaneous Configuration sections ([Figure 11](#)) show the remaining register settings of the MAX77831. Use these sections to control internal compensation resistance, switching frequency, switching current limit, and output voltage change slew rate (using the internal reference voltage DVS slew rate). Refer to the MAX77831 IC data sheet for more information on each available setting. Click **Read** to obtain the setting stored on the IC and click **Write** to apply new settings to the IC.

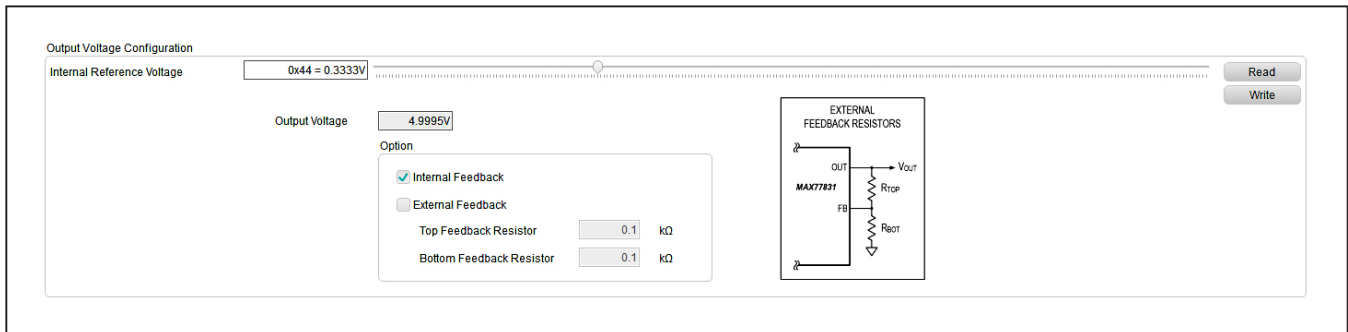

Figure 10. Configuration Tab - Output Voltage Configuration Section

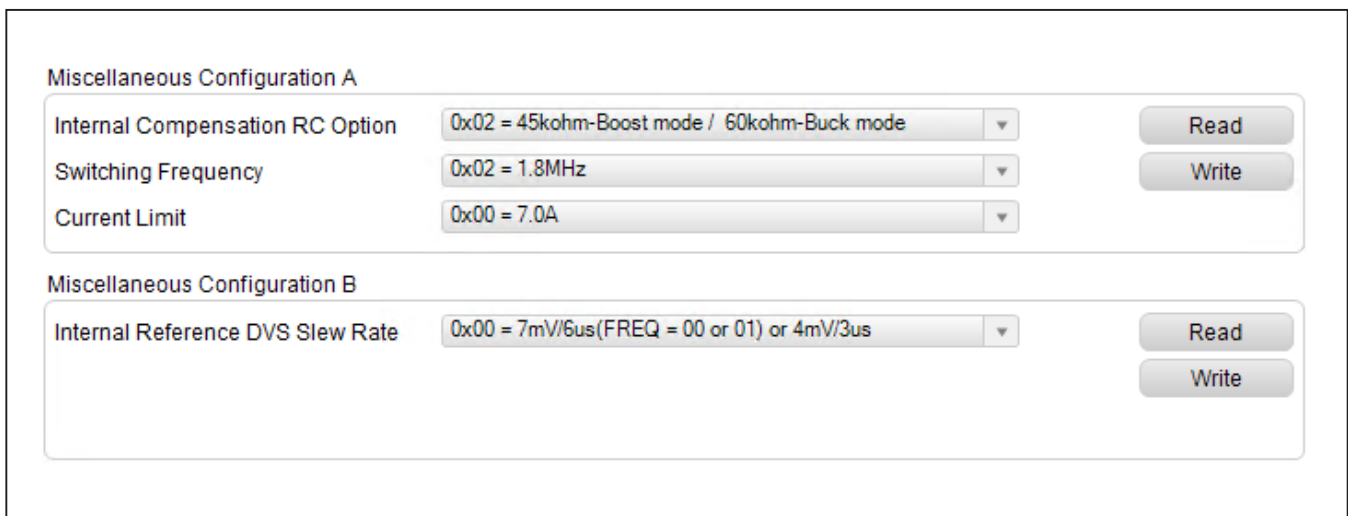

Figure 11. Configuration Tab - Miscellaneous Configuration Sections

### Register Map

The Register Map tab provides an overview of all the MAX77831 registers and the values currently stored on them. Clicking on an individual bit shows the name and description of the specific bitfield.

### Layout Guidelines

Careful circuit board layout is critical to achieve low switching power losses and clean stable operation. The EV kit also serves a Maxim recommended layout of the MAX77831. If the POK or fault interrupt functionality is desired, the high-density interconnect (HDI) PCB is required to route to the POKB/INTB pin. Otherwise, the HDI PCB is recommended but not required. [Figure 13](#) and [Figure 14](#) show example non-HDI and HDI PCB layouts for the MAX77831 WLP package. Use the provided layout files for guidance when designing with the IC. The IC data sheet contains a list of useful tips and guidelines for achieving the best possible layout. They are repeated here for convenience:

- Place the input capacitors ( $C_{IN}$ ) and output capacitors ( $C_{OUT}$ ) immediately next to the IN pin and OUT pin of the IC, respectively. Since the IC operates at a high switching frequency, this placement is critical for minimizing parasitic inductance within the input and output current loops, which can cause high voltage spikes and can damage the internal switching MOSFETs.
- Place the inductor next to the LX bumps (as close as possible) and make the traces between the LX bumps and the inductor short and wide to minimize PCB trace impedance. Excessive PCB impedance reduces converter efficiency. When routing LX traces on a separate layer (as in the examples), make sure to include enough vias to minimize trace impedance. Routing LX traces on multiple layers is recommended to further reduce trace impedance. Furthermore, do not make LX traces take up an excessive amount of area. The voltage on this node switches very quickly and additional area creates more radiated emissions.

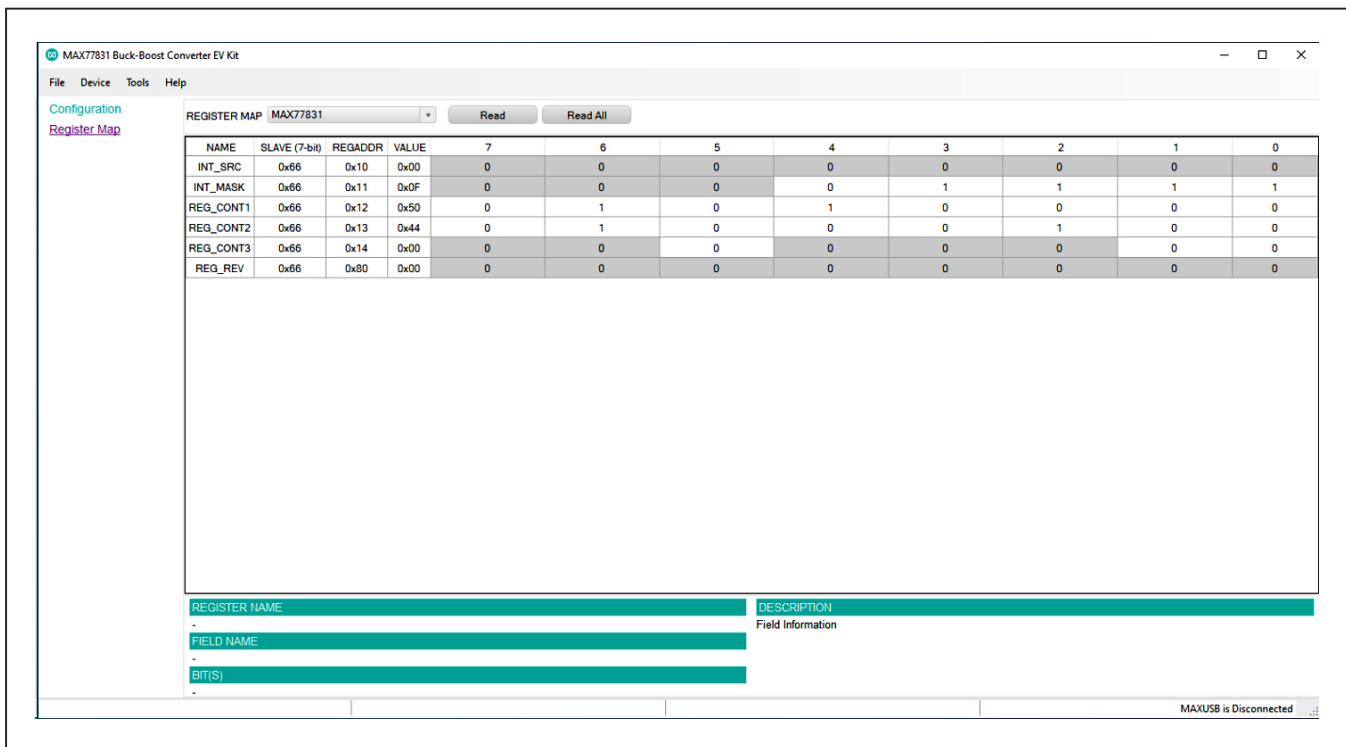

Figure 12. EV Kit GUI Software Register Map Tab

- Route LX nodes to the corresponding bootstrap capacitor ( $C_{BST}$ ) as short as possible. Prioritize  $C_{BST}$  placement to reduce trace length to the IC.
- Connect the inner PGND bumps to the low-impedance ground plane on the PCB with vias placed next to the bumps. Do not create PGND islands, as PGND islands risk interrupting the hot loops. Connect AGND and AGND island to the low-impedance ground plane on the PCB (the same net as PGND).
- Keep the power traces and load connections short and wide. This is essential for high converter efficiency.
- Do not neglect ceramic capacitor DC voltage derating. Choose capacitor values and case sizes carefully. Refer to the Output Capacitor Selection section in the MAX77831 IC datasheet and [Tutorial 5527](#) for more information.

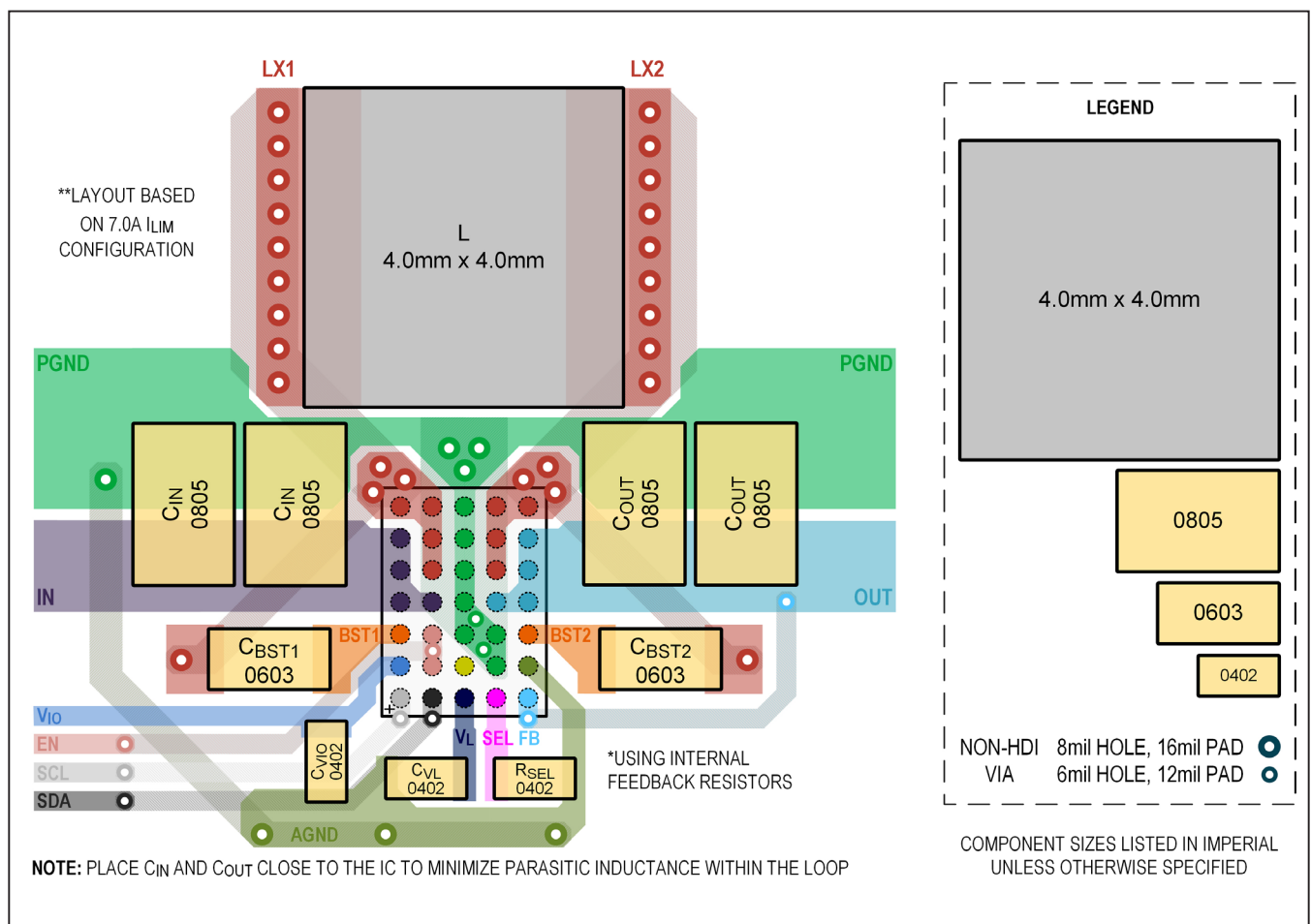

Figure 13. Non-HDI PCB Layout Recommendation (with 4mm x 4mm inductor and without POKB/INTB)

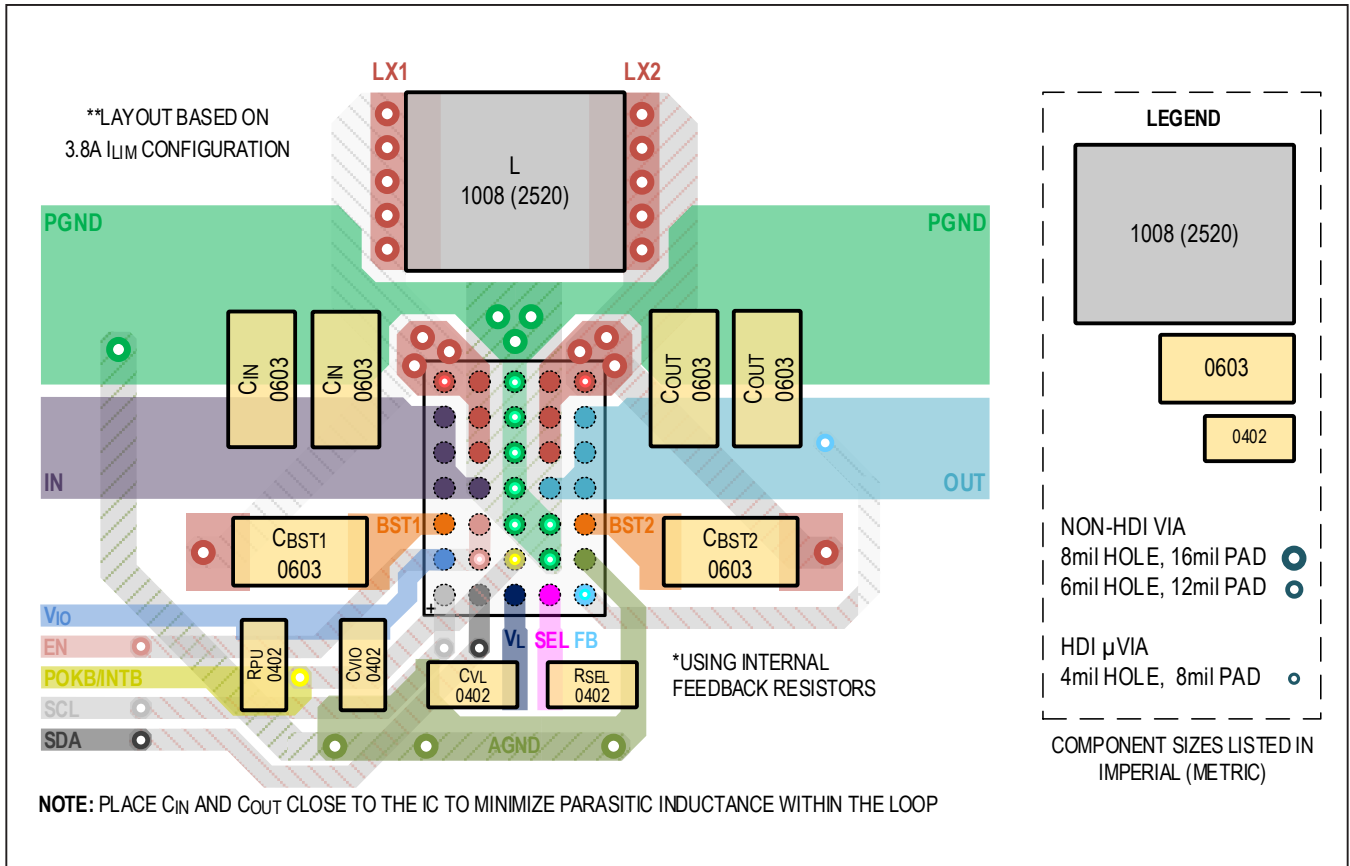

Figure 14. HDI PCB Layout Recommendation (with 2520 Inductor and POKB/INTB)

### Ordering Information

PART	U1 IC	DEFAULT OUTPUT VOLTAGE	TYPE
MAX77831WEVKIT#	MAX77831BEWB+T	5V	EV Kit

#Denotes a RoHS-compliant device that may include lead that is exempt under the RoHS requirements.

+Denotes a lead(Pb)-free/RoHS-compliant package.



MAX77831 EV Kit Bill of Materials

REF DES	QTY	MFG PART #	MANUFACTURER	VALUE	DESCRIPTION
C1	1	T491X107K025A	KEMET	100µF	CAPACITOR; SMT (7343-43); TANTALUM CHIP; 100µF; 25V; TOL = 10%
C2	1	JMK105B7474KVHF	TAIYO YUDEN	0.47µF	CAP; SMT (0402); 0.47µF; 10%; 6.3V; X7R; CERAMIC CHIP
C4, C5	2	GRM21BC71E106KE11	MURATA	10µF	CAPACITOR; SMT (0805); CERAMIC CHIP; 10µF; 25V; TOL = 10%; TG = -55°C TO +125°C; TC = X7S
C6	1	C1005X7S0J225K050BC; GRM155C70J225KE11	TDK;MURATA	2.2µF	CAPACITOR; SMT (0402); CERAMIC CHIP; 2.2µF; 6.3V; TOL = 10%; MODEL = C SERIES; TG = -55°C TO +125°C; TC = X7S
C7, C8	2	GCJ188R71H224KA01	MURATA	0.22µF	CAP; SMT (0603); 0.22µF; 10%; 50V; X7R; CERAMIC CHIP
C10, C11	2	C2012X5R1E226M125AC; CL21A226MAQNNN	TDK; SAMSUNG ELECTRO-MECHANICS	22µF	CAPACITOR; SMT (0805); CERAMIC CHIP; 22µF; 25V; TOL = 20%; TG = -55°C TO +85°C; TC = X5R
C13	1	GRM155R71E104KE14; C1005X7R1E104K050BB; TMK105B7104KVH; CGJ2B3X7R1E104K050BB	MURATA;TDK; TAIYO YUDEN;TDK	0.1µF	CAP; SMT (0402); 0.1µF; 0.1; 25V; X7R; CERAMIC CHIP
EN, POKB/INTB, POT1, POT2, SCL, SDA	6	5002	KEYSTONE	N/A	TEST POINT; PIN DIA = 0.1IN; TOTAL LENGTH = 0.3IN; BOARD HOLE = 0.04IN; WHITE; PHOSPHOR BRONZE WIRE SILVER;
GND, IN, OUT, PGND1, PGND2	5	9020 BUSS	WEICO WIRE	MAXIMPAD	EVK KIT PARTS; MAXIM PAD; WIRE; NATURAL; SOLID; WEICO WIRE; SOFT DRAWN BUS TYPE-S; 20AWG
GND3, GND4	2	5011	KEYSTONE	N/A	TEST POINT; PIN DIA = 0.125IN; TOTAL LENGTH = 0.445IN; BOARD HOLE = 0.063IN; BLACK; PHOSPHOR BRONZE WIRE SILVER PLATE FINISH;
INS, OUTS, VIO, VL	4	5000	KEYSTONE	N/A	TEST POINT; PIN DIA = 0.1IN; TOTAL LENGTH = 0.3IN; BOARD HOLE = 0.04IN; RED; PHOSPHOR BRONZE WIRE SILVER PLATE FINISH;
J1, J2	2	PEC03SAAN	SULLINS ELECTRONICS CORP.	PEC03SAAN	EVKIT PART-CONNECTOR; MALE; THROUGH HOLE; BREAKAWAY; STRAIGHT; 3PINS; -65°C TO +125°C;
J3, J4	2	PBC02SAAN	SULLINS ELECTRONICS CORP.	PBC02SAAN	EVKIT PART-CONNECTOR; MALE; THROUGH HOLE; BREAKAWAY; STRAIGHT; 2PINS; -65°C TO +125°C;
J5	1	PPPC092LJBN-RC	SULLINS ELECTRONICS CORP.	PPPC092LJBN-RC	CONNECTOR; FEMALE; THROUGH HOLE; PPP SERIES; RIGHT ANGLE; 18PINS
L1	1	XEL4020-152ME	COILCRAFT	1.5UH	INDUCTOR; SMT; COMPOSITE; 1.5µH; 20%; 7.5A
MH1-MH4	4	9032	KEYSTONE	9032	MACHINE FABRICATED; ROUND-THRU HOLE SPACER; NO THREAD; M3.5; 5/8IN; NYLON
PGND1S, PGND2S	2	5001	KEYSTONE	N/A	TEST POINT; PIN DIA = 0.1IN; TOTAL LENGTH = 0.3IN; BOARD HOLE = 0.04IN; BLACK; PHOSPHOR BRONZE WIRE SILVER PLATE FINISH;
R3, R9, R10, R12	4	ERJ-2GE0R00	PANASONIC	0	RESISTOR; 0402; 0Ω; 0%; JUMPER; 0.10W; THICK FILM
R4, R7	2	CRCW04022K20FK; RC0402FR-072K2L	VISHAY DALE; YAGEO PHICOMP	2.2K	RESISTOR, 0402, 2.2KΩ, 1%, 100PPM, 0.0625W, THICK FILM
R13	1	ERJ-2RKF1502	PANASONIC	15K	RESISTOR; 0402; 15KΩ; 1%; 100PPM; 0.1W; THICK FILM
U1	1	MAX77831BEWB+	MAXIM	MAX77831BEWB+	EVKIT PART - IC; MAX77831BEWB+; PACKAGE OUTLINE DRAWING: 21-100367; PACKAGE CODE: W352A2+1; WLP35
PACK-OUT	1	MAXUSB_ INTERFACE#	MAXIM	MAXUSB_ INTERFACE#	ASSEMBLED BOARD
PCB	1	MAX77831WLP	MAXIM	PCB	PCB:MAX77831WLP
LX1, LX2, OUT1	DNP	SS-102-TT-2	SAMTEC	SS-102-TT-2	IC-SOCKET; SIP; STRAIGHT; PRECISION MACHINED SOCKET STRIP; OPEN FRAME; 2PINS; 100MIL
R2, R8	DNP	3296Y-1-204LF	BOURNS	200K	RESISTOR; THROUGH HOLE-RADIAL LEAD; 3296 SERIES; 200KΩ; 10%; 100PPM; 0.5W
C3, C12	DNP	N/A	N/A	OPEN	CAPACITOR; SMT (0805); OPEN; FORMFACTOR
C9	DNP	N/A	N/A	OPEN	CAPACITOR; SMT (0402); OPEN; FORMFACTOR
R1, R5, R6, R11	DNP	N/A	N/A	OPEN	RESISTOR; 0402; OPEN; FORMFACTOR
	<b>48</b>				

MAX77831 EV Kit Schematic Diagram

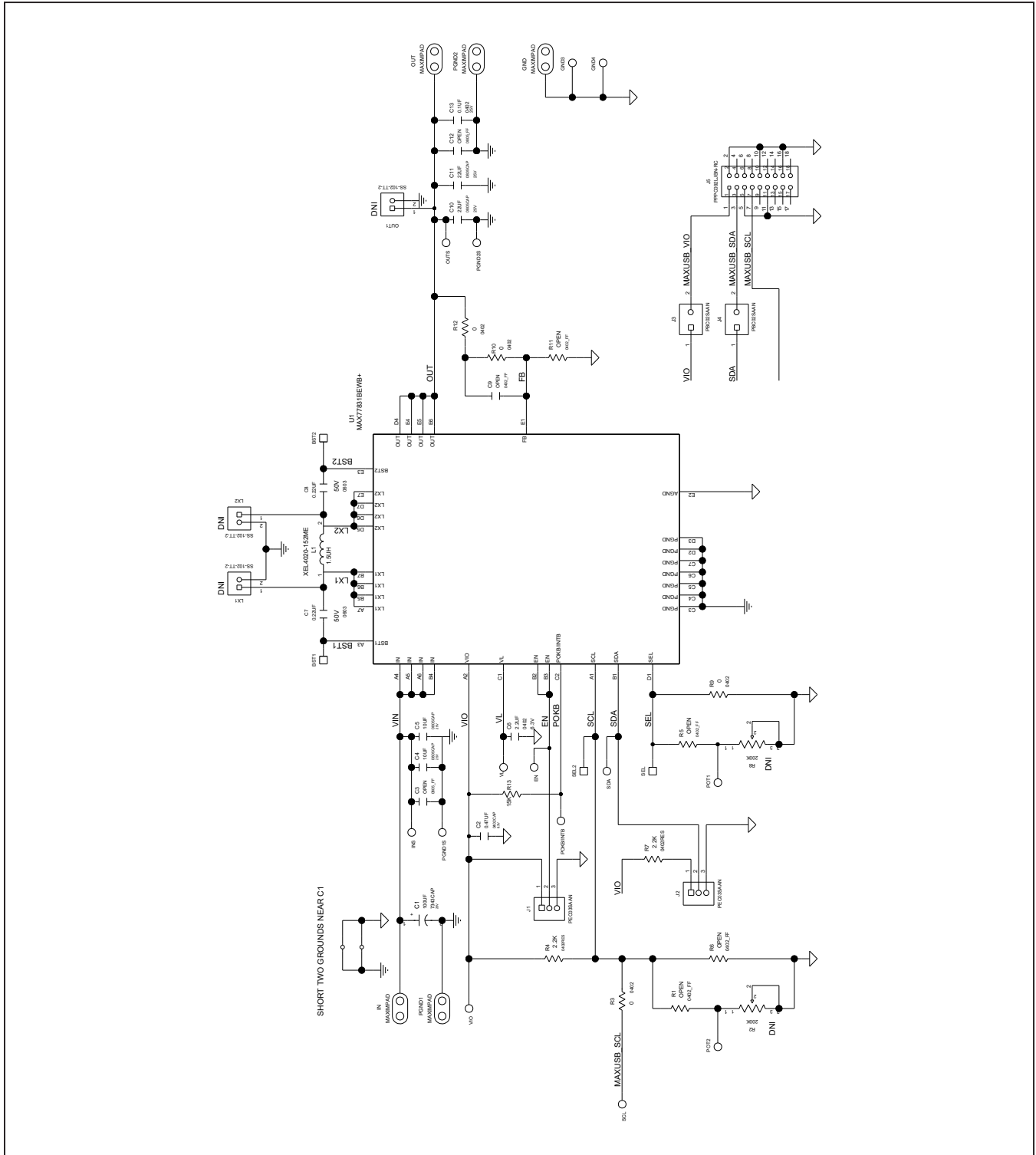

MAX77831 EV Kit Schematic Diagram

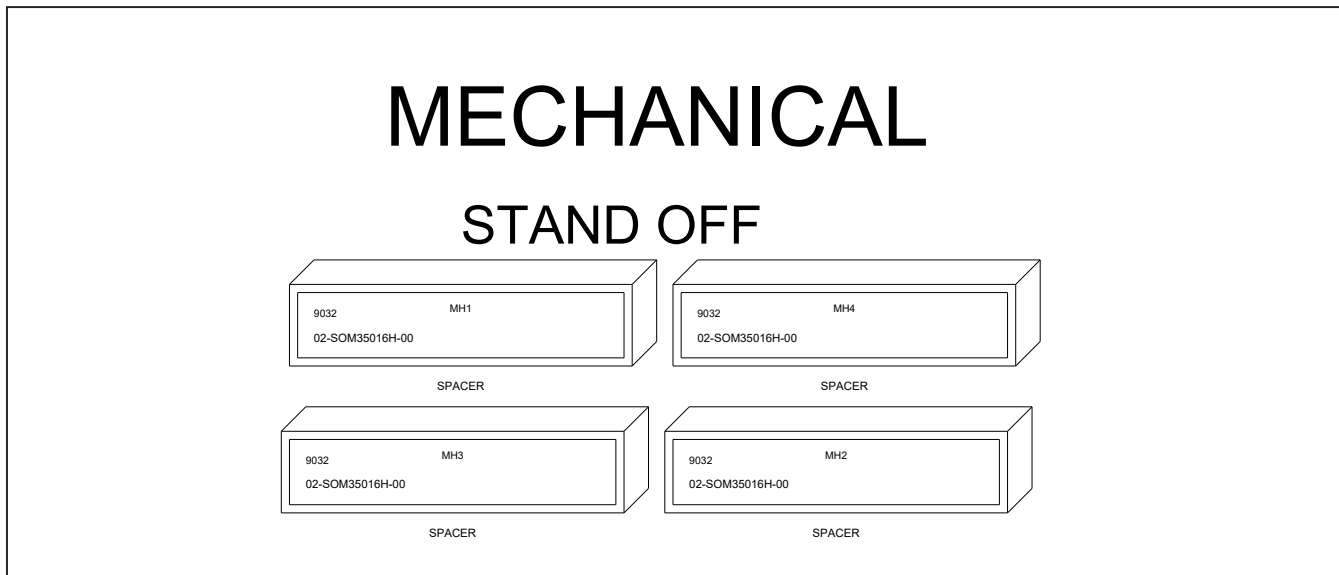

MAX77831 EV Kit PCB Layout Diagrams

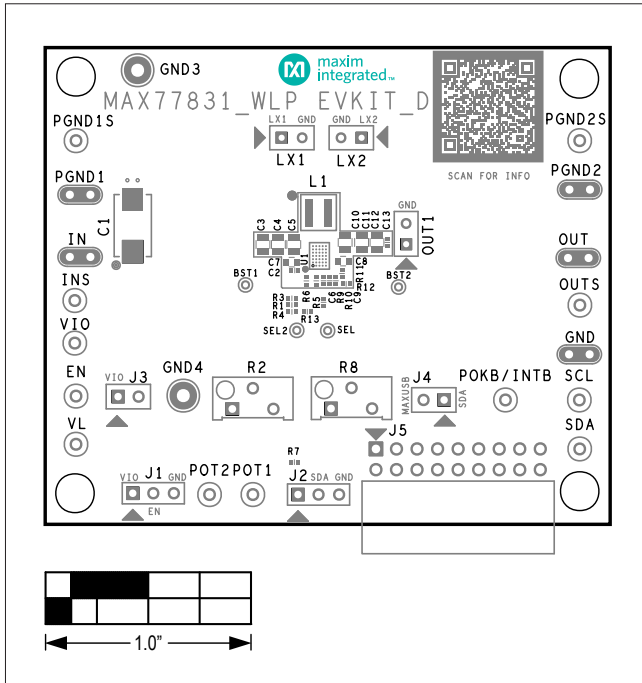

MAX77831 EV Kit PCB Layout — Top Silkscreen

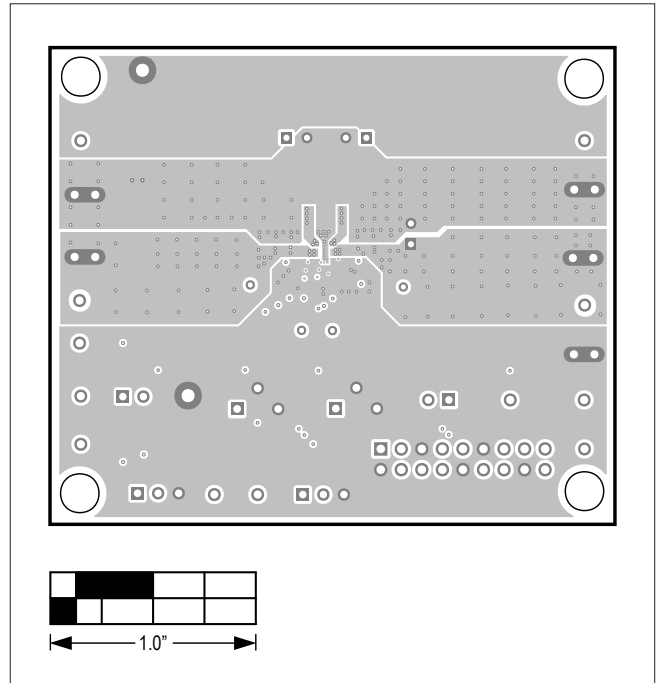

MAX77831 EV Kit PCB Layout — Internal 2

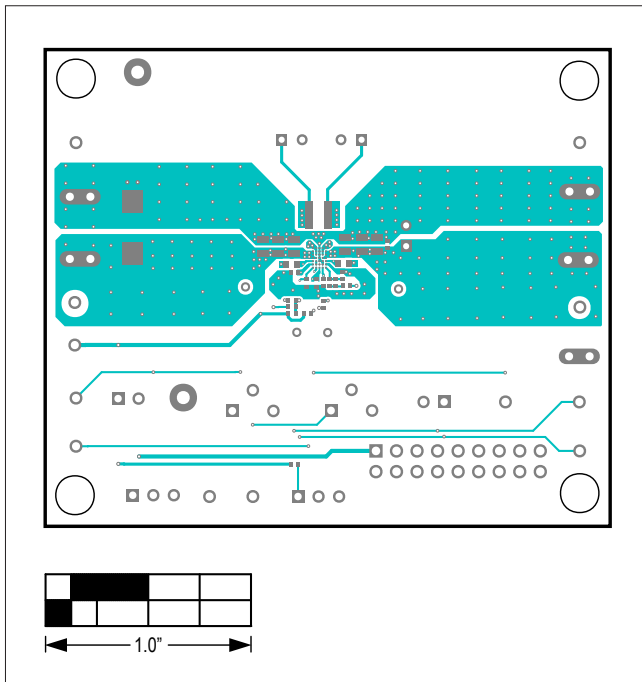

MAX77831 EV Kit PCB Layout — Top View

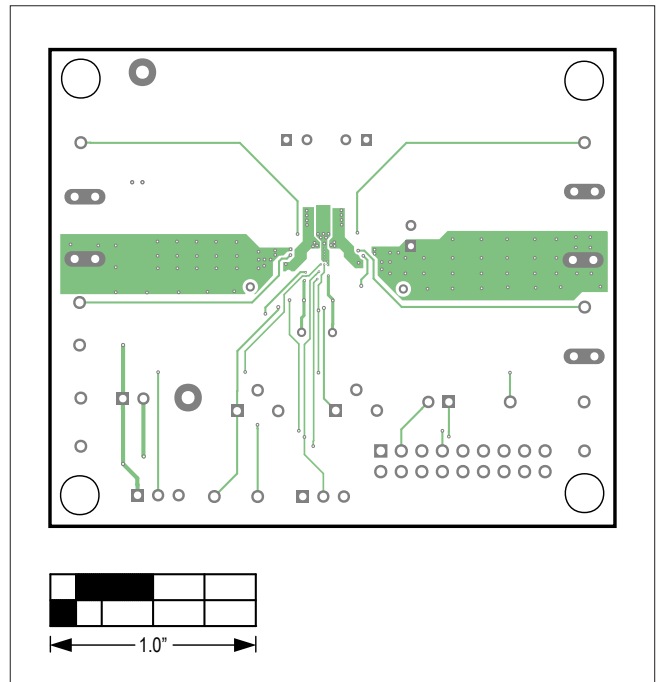

MAX77831 EV Kit PCB Layout — Internal 3

MAX77831 EV Kit PCB Layout Diagrams (continued)

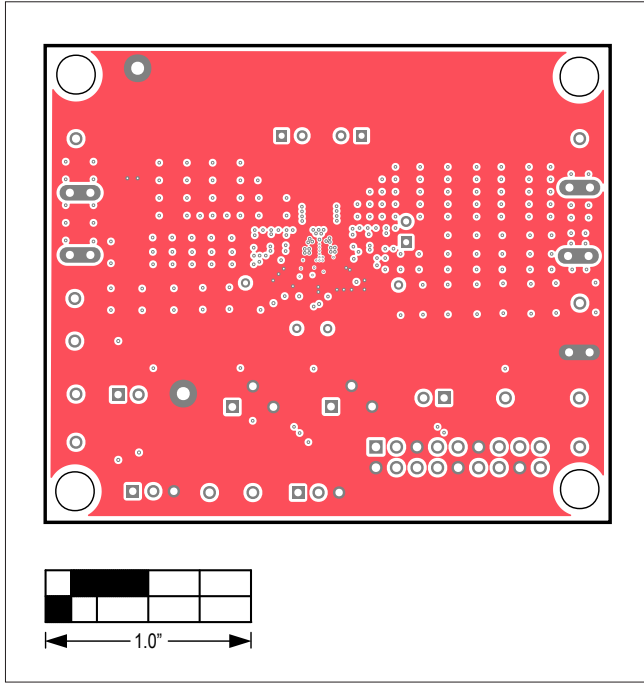

MAX77831 EV Kit PCB Layout — Internal 4

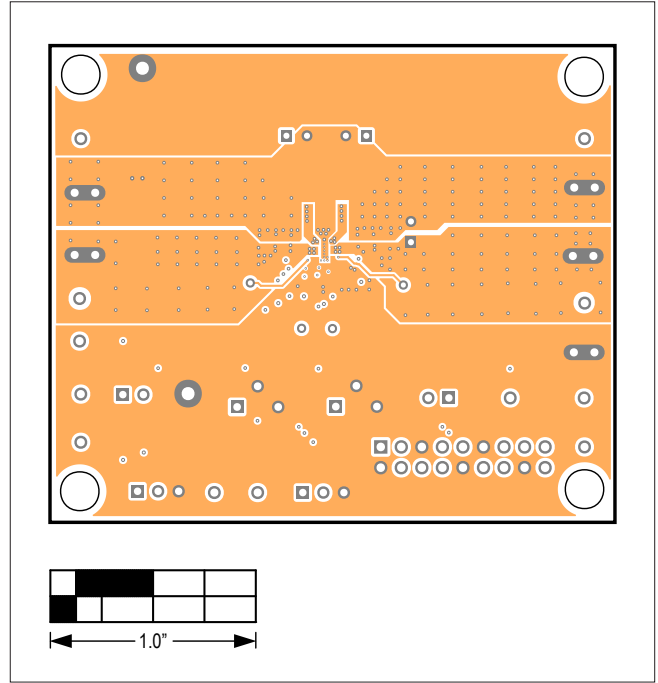

MAX77831 EV Kit PCB Layout — Internal 5

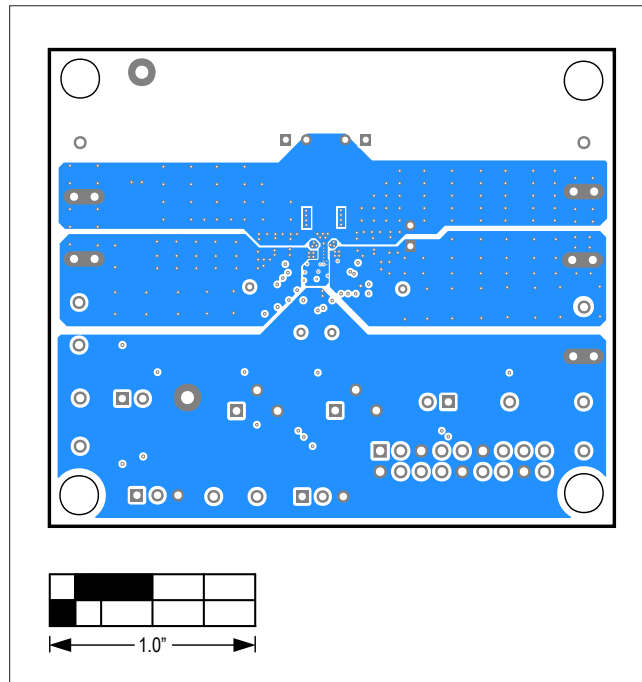

MAX77831 EV Kit PCB Layout — Bottom View



Revision History

REVISION NUMBER	REVISION DATE	DESCRIPTION	PAGES CHANGED
0	9/20	Initial release	—
1	9/21	Updated <i>General Description</i> and <i>Benefits and Features</i> sections, <i>MAX77831 EV Kit Specifications</i> table, Figure 2, updated <i>EV Kit Default Configuration, Quick Start</i> , Table 1, Table 3, updated <i>MAXUSB_INTERFACE#</i> , <i>External I<sup>2</sup>C Bus</i> , <i>High Temperature Testing</i> , <i>Critical Node Measurement (OUT and LX)</i> , and <i>EV Kit Software</i> , added Figure 3 and Table 4, updated <i>Windows Driver</i> and <i>Connecting GUI to MAXUSB_INTERFACE#</i> sections	1–7



Information furnished by Analog Devices is believed to be accurate and reliable. However, no responsibility is assumed by Analog Devices for its use, nor for any infringements of patents or other rights of third parties that may result from its use. Specifications subject to change without notice. No license is granted by implication or otherwise under any patent or patent rights of Analog Devices. Trademarks and registered trademarks are the property of their respective owners.