

# ESD and Surge Protection Diode

Low Clamping Voltage

## NSPU5201, NSPU5221 Series

### Features

- Unidirectional High Voltage ESD and Surge Protection
- Provides ESD Protection to IEC61000-4-2 Level 4:  $\pm 30$  kV Contact Discharge
- Small Package: 1.8 mm x 2.0 mm
- These Devices are Pb-Free, Halogen Free/BFR Free and are RoHS Compliant

### APPLICATION DIAGRAM

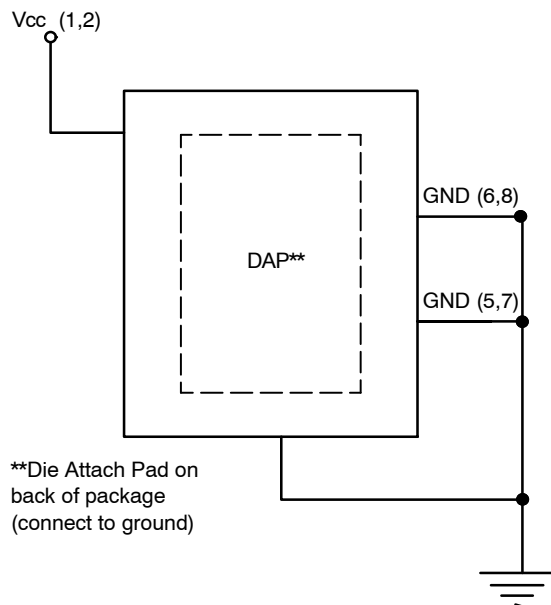

ON Semiconductor®

[www.onsemi.com](http://www.onsemi.com)



UDFN6  
CASE 517CS

### BLOCK DIAGRAM

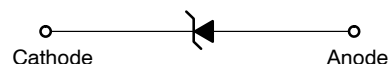

### MARKING DIAGRAM



XX = Specific Device Code  
M = Date Code  
▪ = Pb-Free Package

### ORDERING INFORMATION

Device	Package	Shipping <sup>†</sup>
NSPU5201MUTBG	UDFN6 (Pb-Free)	3000 / Tape & Reel
NSPU5221MUTBG	UDFN6 (Pb-Free)	3000 / Tape & Reel

<sup>†</sup>For information on tape and reel specifications, including part orientation and tape sizes, please refer to our Tape and Reel Packaging Specification Brochure, BRD8011/D.

# NSPU5201, NSPU5221 Series

**Table 1. PIN DESCRIPTIONS**

6-Lead, UDFN8 Package		
Pin	Name	Description
1	V <sub>CC</sub>	Cathode
2	V <sub>CC</sub>	Cathode
3	N/C	No Connect
4	N/C	No Connect
5	GND	Anode
6	GND	Anode
7	GND	Anode
8	GND	Anode

## PACKAGE / PINOUT DIAGRAMS

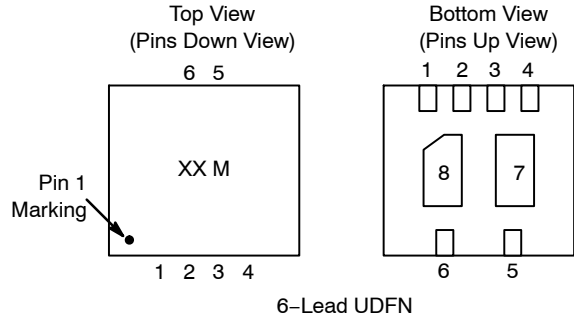

## ELECTRICAL CHARACTERISTICS

Symbol	Parameter
I <sub>PP</sub>	Maximum Reverse Peak Pulse Current
V <sub>C</sub>	Clamping Voltage @ I <sub>PP</sub>
V <sub>RWM</sub>	Working Peak Reverse Voltage
I <sub>R</sub>	Maximum Reverse Leakage Current @ V <sub>RWM</sub>
V <sub>BR</sub>	Breakdown Voltage @ I <sub>T</sub>
I <sub>T</sub>	Test Current
ΘV <sub>BR</sub>	Maximum Temperature Coefficient of V <sub>BR</sub>
I <sub>F</sub>	Forward Current
V <sub>F</sub>	Forward Voltage @ I <sub>F</sub>

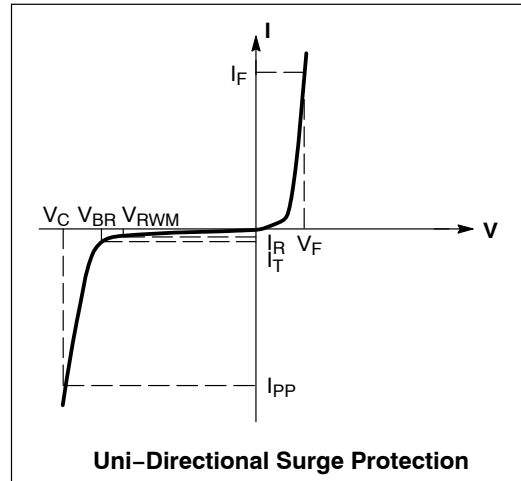

# NSPU5201, NSPU5221 Series

## SPECIFICATIONS

**Table 2. MAXIMUM RATINGS**

Parameter	Rating	Units
Operating Temperature Range	-55 to +125	°C
Storage Temperature Range	-65 to +150	°C

Stresses at or above those listed in Maximum Ratings table may cause permanent damage to the device. This is a stress only rating and operation of the device at these or any other conditions above those indicated in the operational sections of this specification is not implied. Also, due to variations in test equipment, stresses shown above are averages.

### ELECTRICAL CHARACTERISTICS

Device Name	Device Marking	V <sub>RWM</sub> (V) Max	I <sub>R</sub> @ V <sub>RWM</sub> (μA) Max	Breakdown Voltage				I <sub>PP</sub> (A) (8 x 20 μs)	V <sub>C</sub> @ I <sub>PP</sub> (8 x 20 μs)	
				V <sub>BR</sub> V			@ I <sub>T</sub> (mA)	Min	V <sub>C</sub> (V) Max	I <sub>PP</sub> (A)
				Min	Nom	Max				
NSPU5201	AZ	20	1	21.7	22.7	23.7	1	140	31.5	110
NSPU5221	A2	20	1	24	25	26	1	120	33	100
		22	2						35	120

Product parametric performance is indicated in the Electrical Characteristics for the listed test conditions, unless otherwise noted. Product performance may not be indicated by the Electrical Characteristics if operated under different conditions.

### ELECTRICAL CHARACTERISTICS (NSPU5221)

	Description	Min	Typ	Max	Unit
V <sub>CLAMP</sub> Clamp Voltage	24 A IEC61000-4-5 Surge (8/20 μs) from IO to GND, V <sub>IN</sub> = 0 V before surge, 25°C		26.8	28.5	V
	40 A IEC61000-4-5 Surge (8/20 μs) from IO to GND, V <sub>IN</sub> = 0 V before surge, 25°C		28.3	30	V
	35 A IEC61000-4-5 Surge (8/20 μs) from IO to GND, V <sub>IN</sub> = V <sub>RWM</sub> before surge, T <sub>A</sub> = 125°C		29.4	31	V

# NSPU5201, NSPU5221 Series

## TYPICAL CHARACTERISTICS

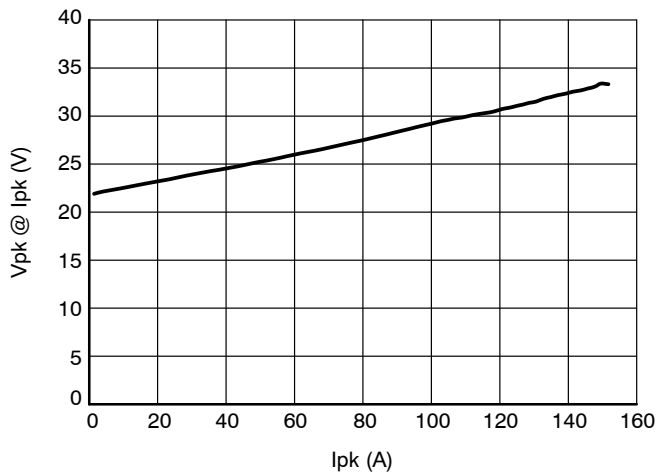

**Figure 1. NSPU5201 Positive Clamping Voltage vs. Peak Pulse Current ( $t_p = 8/20 \mu s$ )**

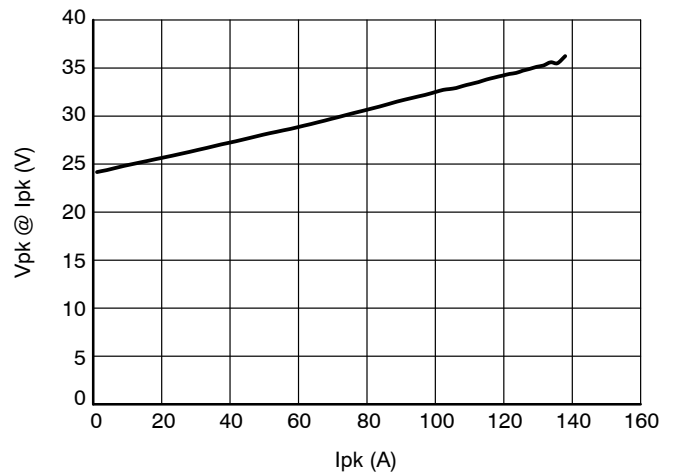

**Figure 2. NSPU5221 Positive Clamping Voltage vs. Peak Pulse Current ( $t_p = 8/20 \mu s$ )**

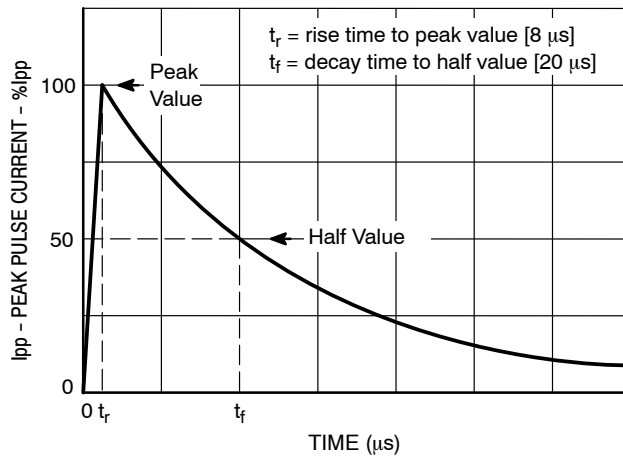

**Figure 3. IEC61000-4-5 8/20 μs Pulse Waveform**

# MECHANICAL CASE OUTLINE

## PACKAGE DIMENSIONS

ON Semiconductor®



SCALE 4:1

### UDFN6, 1.8x2, 0.4P CASE 517CS ISSUE 0

DATE 30 APR 2013

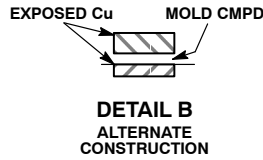
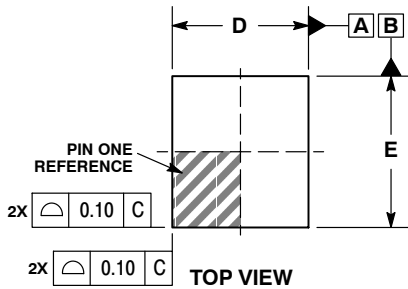

- NOTES:
1. DIMENSIONING AND TOLERANCING PER ASME Y14.5M, 1994.
  2. CONTROLLING DIMENSION: MILLIMETERS.
  3. DIMENSION b APPLIES TO PLATED TERMINALS AND IS MEASURED BETWEEN 0.15 AND 0.30mm FROM THE TERMINAL TIP.
  4. COPLANARITY APPLIES TO THE EXPOSED PAD AS WELL AS THE TERMINALS.

DIM	MILLIMETERS	
	MIN	MAX
A	0.45	0.55
A1	0.00	0.05
A3	0.125 REF	
b	0.15	0.25
D	1.80 BSC	
D2	0.35	0.55
E	2.00 BSC	
E2	0.74	0.94
e	0.40 BSC	
e1	0.80 BSC	
e2	0.95 BSC	
L	0.20	0.40
L1	---	0.15

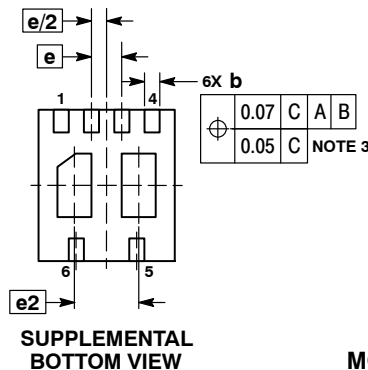
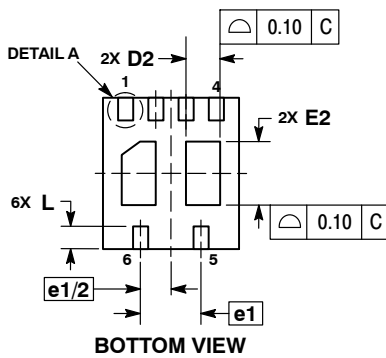
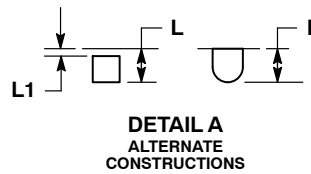
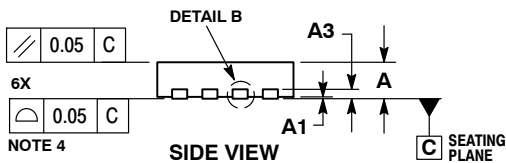

### GENERIC MARKING DIAGRAM\*



XX = Specific Device Code  
M = Date Code

\*This information is generic. Please refer to device data sheet for actual part marking. Pb-Free indicator, "G" or microdot "▪", may or may not be present.

### RECOMMENDED MOUNTING FOOTPRINT\*

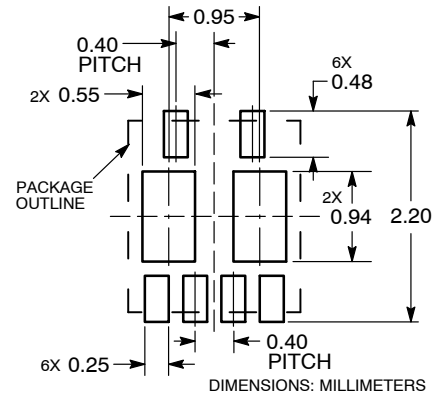

\*For additional information on our Pb-Free strategy and soldering details, please download the ON Semiconductor Soldering and Mounting Techniques Reference Manual, SOLDERRM/D.

<b>DOCUMENT NUMBER:</b>	<b>98AON89602E</b>	Electronic versions are uncontrolled except when accessed directly from the Document Repository. Printed versions are uncontrolled except when stamped "CONTROLLED COPY" in red.
<b>DESCRIPTION:</b>	<b>UDFN6 1.8X2, 0.4P</b>	<b>PAGE 1 OF 1</b>

ON Semiconductor and ON are trademarks of Semiconductor Components Industries, LLC dba ON Semiconductor or its subsidiaries in the United States and/or other countries. ON Semiconductor reserves the right to make changes without further notice to any products herein. ON Semiconductor makes no warranty, representation or guarantee regarding the suitability of its products for any particular purpose, nor does ON Semiconductor assume any liability arising out of the application or use of any product or circuit, and specifically disclaims any and all liability, including without limitation special, consequential or incidental damages. ON Semiconductor does not convey any license under its patent rights nor the rights of others.

**onsemi**, **Onsemi**, and other names, marks, and brands are registered and/or common law trademarks of Semiconductor Components Industries, LLC dba "**onsemi**" or its affiliates and/or subsidiaries in the United States and/or other countries. **onsemi** owns the rights to a number of patents, trademarks, copyrights, trade secrets, and other intellectual property. A listing of **onsemi**'s product/patent coverage may be accessed at [www.onsemi.com/site/pdf/Patent-Marking.pdf](http://www.onsemi.com/site/pdf/Patent-Marking.pdf). **onsemi** reserves the right to make changes at any time to any products or information herein, without notice. The information herein is provided "as-is" and **onsemi** makes no warranty, representation or guarantee regarding the accuracy of the information, product features, availability, functionality, or suitability of its products for any particular purpose, nor does **onsemi** assume any liability arising out of the application or use of any product or circuit, and specifically disclaims any and all liability, including without limitation special, consequential or incidental damages. Buyer is responsible for its products and applications using **onsemi** products, including compliance with all laws, regulations and safety requirements or standards, regardless of any support or applications information provided by **onsemi**. "Typical" parameters which may be provided in **onsemi** data sheets and/or specifications can and do vary in different applications and actual performance may vary over time. All operating parameters, including "Typicals" must be validated for each customer application by customer's technical experts. **onsemi** does not convey any license under any of its intellectual property rights nor the rights of others. **onsemi** products are not designed, intended, or authorized for use as a critical component in life support systems or any FDA Class 3 medical devices or medical devices with a same or similar classification in a foreign jurisdiction or any devices intended for implantation in the human body. Should Buyer purchase or use **onsemi** products for any such unintended or unauthorized application, Buyer shall indemnify and hold **onsemi** and its officers, employees, subsidiaries, affiliates, and distributors harmless against all claims, costs, damages, and expenses, and reasonable attorney fees arising out of, directly or indirectly, any claim of personal injury or death associated with such unintended or unauthorized use, even if such claim alleges that **onsemi** was negligent regarding the design or manufacture of the part. **onsemi** is an Equal Opportunity/Affirmative Action Employer. This literature is subject to all applicable copyright laws and is not for resale in any manner.

## PUBLICATION ORDERING INFORMATION

### LITERATURE FULFILLMENT:

Email Requests to: [orderlit@onsemi.com](mailto:orderlit@onsemi.com)

**onsemi Website:** [www.onsemi.com](http://www.onsemi.com)

### TECHNICAL SUPPORT

**North American Technical Support:**

Voice Mail: 1 800-282-9855 Toll Free USA/Canada

Phone: 011 421 33 790 2910

**Europe, Middle East and Africa Technical Support:**

Phone: 00421 33 790 2910

For additional information, please contact your local Sales Representative