

N-channel 100 V, 17 mΩ typ., 8 A STripFET™ F7 Power MOSFET in a PowerFLAT™ 3.3x3.3 package

Datasheet - production data

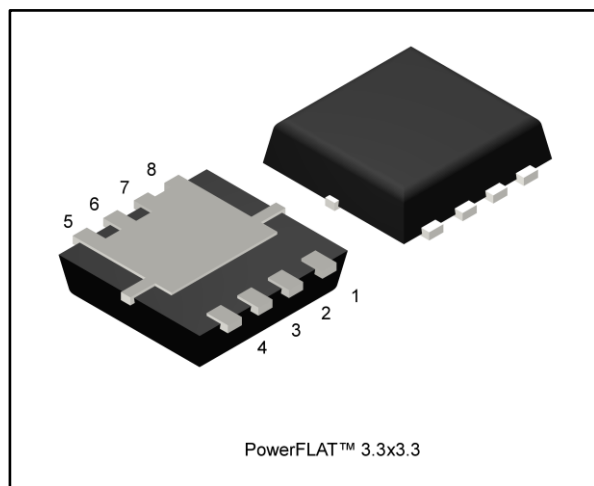
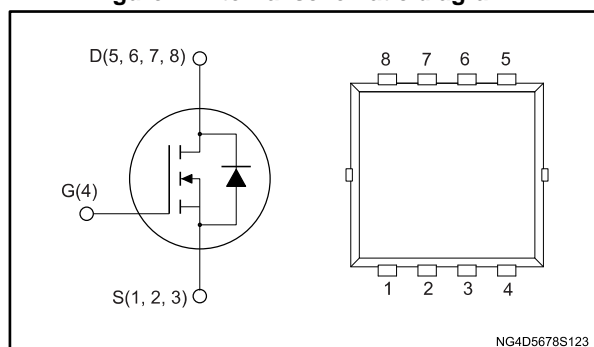

Figure 1: Internal schematic diagram



Features

Order code	V _{DS}	R _{DS(on)} max.	I _D	P _{TOT}
STL8N10F7	100 V	20 mΩ	8 A	2.9 W

- Among the lowest R_{DS(on)} on the market
- Excellent FoM (figure of merit)
- Low C_{rss}/C_{iss} ratio for EMI immunity
- High avalanche ruggedness

Applications

- Switching applications

Description

This N-channel Power MOSFET utilizes STripFET™ F7 technology with an enhanced trench gate structure that results in very low on-state resistance, while also reducing internal capacitance and gate charge for faster and more efficient switching.

Table 1: Device summary

Order code	Marking	Package	Packing
STL8N10F7	8N10F	PowerFLAT™ 3.3x3.3	Tape and reel

Contents

1	Electrical ratings	3
2	Electrical characteristics	4
	2.1 Electrical characteristics (curves)	6
3	Test circuits	8
4	Package information	9
	4.1 PoweFLAT 3.3x3.3 package information	10
5	Revision history	13

1 Electrical ratings

Table 2: Absolute maximum ratings

Symbol	Parameter	Value	Unit
V_{DS}	Drain-source voltage	100	V
V_{GS}	Gate-source voltage	± 20	V
$I_D^{(1)}$	Drain current (continuous) at $T_{pcb} = 25\text{ }^\circ\text{C}$	8	A
$I_D^{(1)}$	Drain current (continuous) at $T_{pcb} = 100\text{ }^\circ\text{C}$	6	A
$I_D^{(2)}$	Drain current (continuous) at $T_c = 25\text{ }^\circ\text{C}$	35	A
$I_D^{(2)}$	Drain current (continuous) at $T_c = 100\text{ }^\circ\text{C}$	22	A
$I_{DM}^{(1)(3)}$	Drain current (pulsed)	32	A
$I_{DM}^{(2)(3)}$	Drain current (pulsed)	140	A
$P_{TOT}^{(2)}$	Total dissipation at $T_c = 25\text{ }^\circ\text{C}$	50	W
$P_{TOT}^{(1)}$	Total dissipation at $T_{pcb} = 25\text{ }^\circ\text{C}$	2.9	W
T_{stg}	Storage temperature range	-55 to 150	$^\circ\text{C}$
T_j	Operating junction temperature range		$^\circ\text{C}$

Notes:

- (1) This value is rated according to $R_{thj-pcb}$.
 (2) This value is rated according to $R_{thj-case}$.
 (3) Pulse width limited by safe operating area.

Table 3: Thermal data

Symbol	Parameter	Value	Unit
$R_{thj-case}$	Thermal resistance junction-case	2.5	$^\circ\text{C}/\text{W}$
$R_{thj-pcb}^{(1)}$	Thermal resistance junction-pcb	42.8	

Notes:

- (1) When mounted on FR-4 board of 1inch², 2oz Cu, $t < 10\text{ s}$.

2 Electrical characteristics

($T_C = 25\text{ }^\circ\text{C}$ unless otherwise specified)

Table 4: Static

Symbol	Parameter	Test conditions	Min.	Typ.	Max.	Unit
$V_{(BR)DSS}$	Drain-source breakdown voltage	$V_{GS} = 0\text{ V}$, $I_D = 1\text{ mA}$	100			V
I_{DSS}	Zero gate voltage drain current	$V_{GS} = 0\text{ V}$, $V_{DS} = 100\text{ V}$			1	μA
		$V_{GS} = 0\text{ V}$, $V_{DS} = 100\text{ V}$, $T_c = 125\text{ }^\circ\text{C}$ ⁽¹⁾			100	μA
I_{GSS}	Gate-body leakage current	$V_{DS} = 0\text{ V}$, $V_{GS} = \pm 20\text{ V}$			± 100	nA
$V_{GS(th)}$	Gate threshold voltage	$V_{DS} = V_{GS}$, $I_D = 250\text{ }\mu\text{A}$	2.5		4.5	V
$R_{DS(on)}$	Static drain-source on-resistance	$V_{GS} = 10\text{ V}$, $I_D = 4\text{ A}$		17	20	m Ω

Notes:

⁽¹⁾Defined by design, not subject to production test.

Table 5: Dynamic

Symbol	Parameter	Test conditions	Min.	Typ.	Max.	Unit
C_{iss}	Input capacitance	$V_{DS} = 50\text{ V}$, $f = 1\text{ MHz}$, $V_{GS} = 0\text{ V}$	-	1640	-	pF
C_{oss}	Output capacitance		-	360	-	pF
C_{rss}	Reverse transfer capacitance		-	25	-	pF
Q_g	Total gate charge	$V_{DD} = 50\text{ V}$, $I_D = 8\text{ A}$, $V_{GS} = 0\text{ to }10\text{ V}$ (see Figure 14: "Test circuit for gate charge behavior")	-	25	-	nC
Q_{gs}	Gate-source charge		-	12	-	nC
Q_{gd}	Gate-drain charge		-	5	-	nC

Table 6: Switching times

Symbol	Parameter	Test conditions	Min.	Typ.	Max.	Unit
$t_{d(on)}$	Turn-on delay time	$V_{DD} = 50\text{ V}$, $I_D = 4\text{ A}$, $R_G = 4.7\text{ }\Omega$, $V_{GS} = 10\text{ V}$ (see Figure 13: "Test circuit for resistive load switching times" and Figure 18: "Switching time waveform")	-	15	-	ns
t_r	Rise time		-	17	-	ns
$t_{d(off)}$	Turn-off-delay time		-	24	-	ns
t_f	Fall time		-	8	-	ns

Table 7: Source-drain diode

Symbol	Parameter	Test conditions	Min.	Typ.	Max.	Unit
$V_{SD}^{(1)}$	Forward on voltage	$V_{GS} = 0\text{ V}$, $I_{SD} = 8\text{ A}$	-		1.1	V
t_{rr}	Reverse recovery time	$I_{SD} = 8\text{ A}$, $di/dt = 100\text{ A}/\mu\text{s}$, $V_{DD} = 80\text{ V}$, $T_j = 150\text{ }^\circ\text{C}$ (see Figure 15: "Test circuit for inductive load switching and diode recovery times")	-	53		ns
Q_{rr}	Reverse recovery charge		-	67		nC
I_{RRM}	Reverse recovery current		-	2.5		A

Notes:

⁽¹⁾Pulse test: pulse duration = 300 μs , duty cycle 1.5%

2.1 Electrical characteristics (curves)

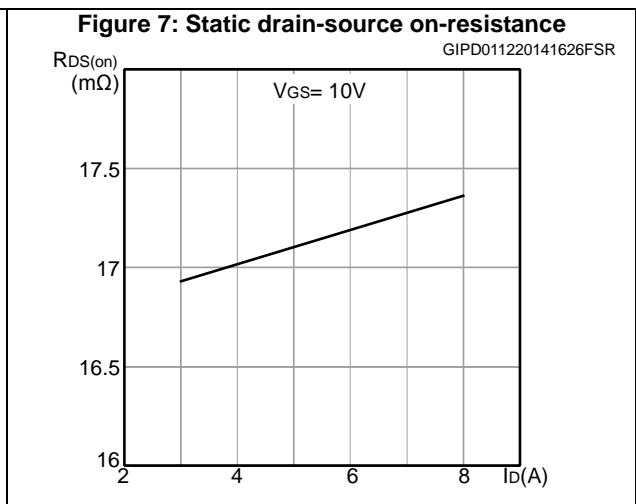
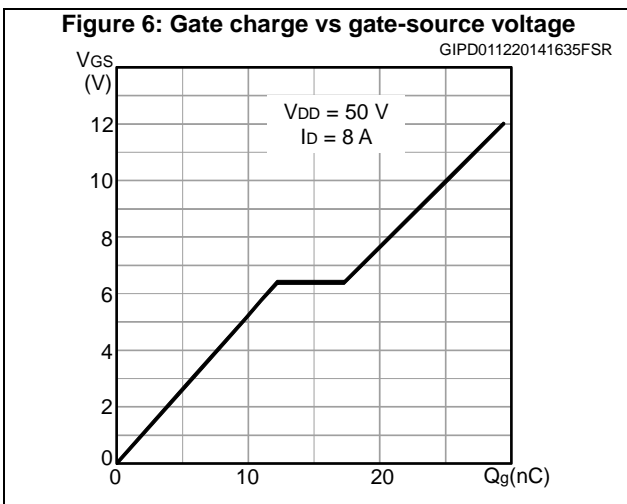
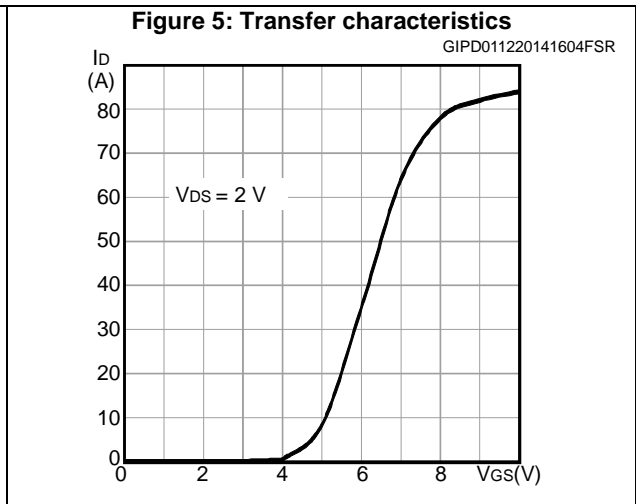
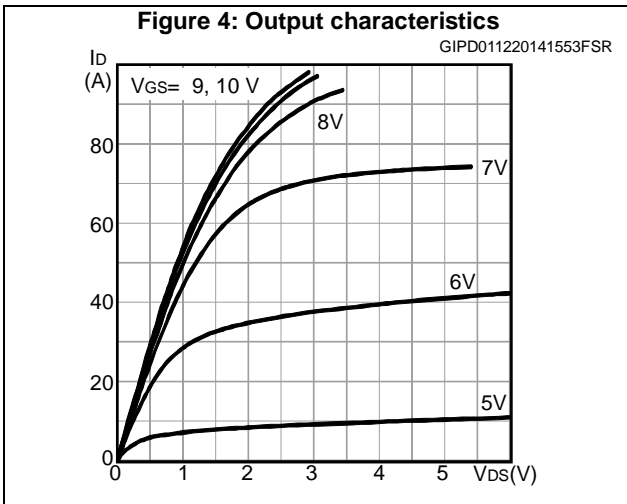
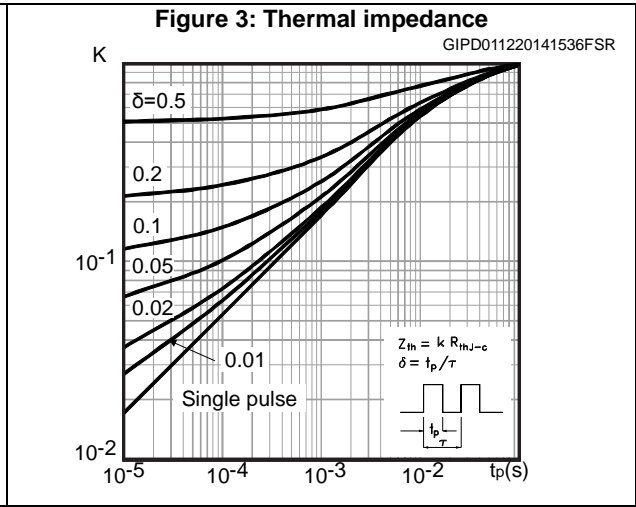
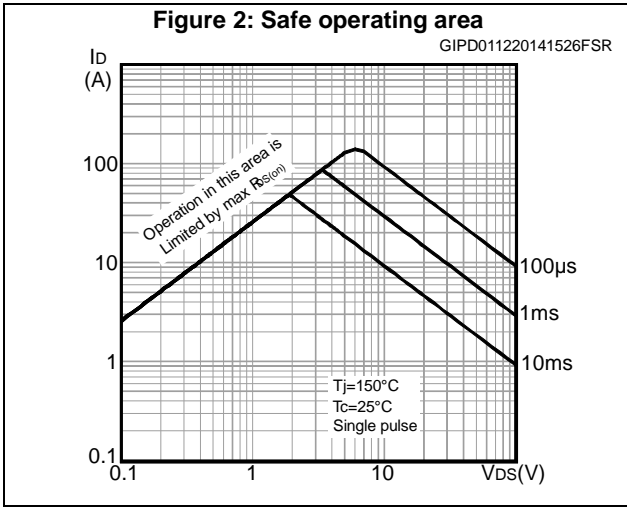

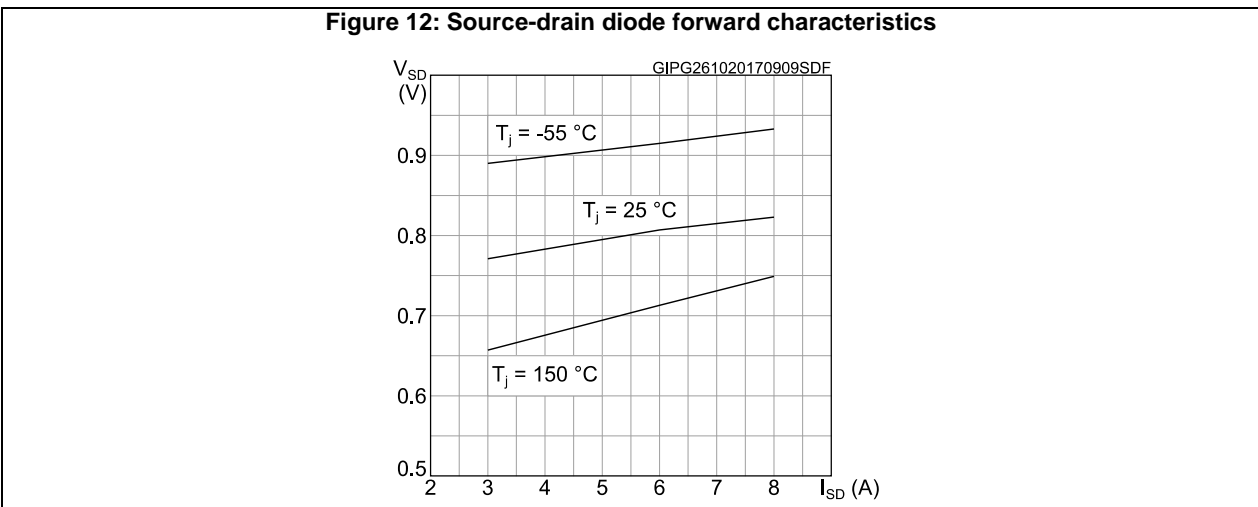
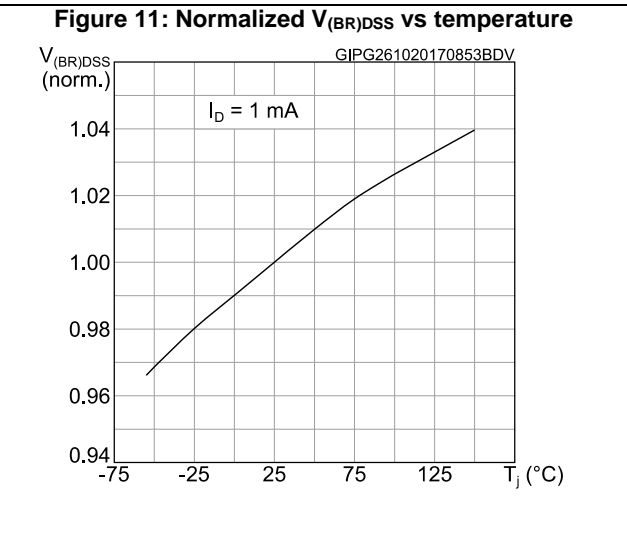
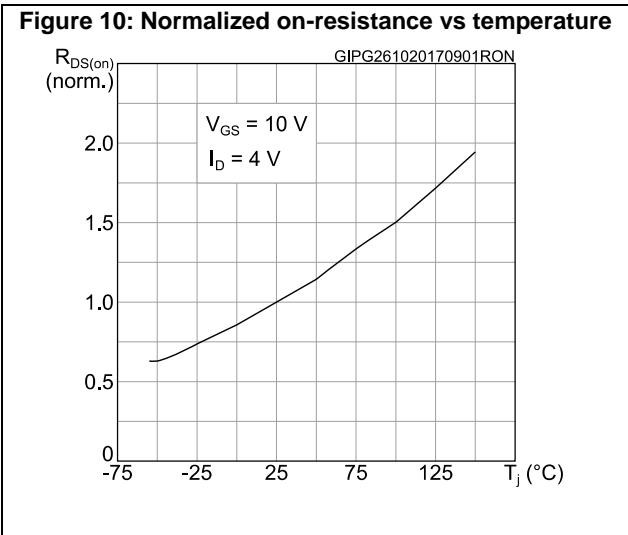
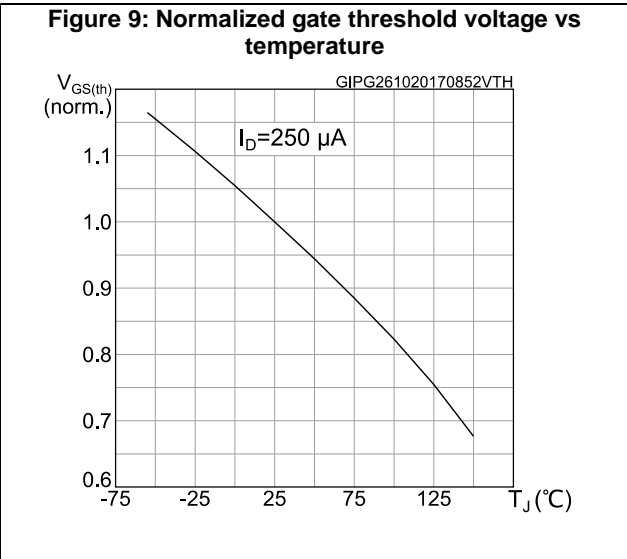
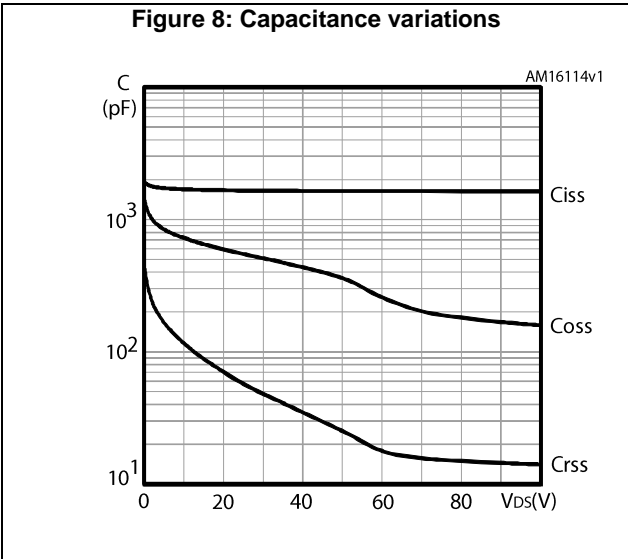

3 Test circuits

Figure 13: Test circuit for resistive load switching times



AM01468v1

Figure 14: Test circuit for gate charge behavior



AM01469v1

Figure 15: Test circuit for inductive load switching and diode recovery times



AM01470v1

Figure 16: Unclamped inductive load test circuit

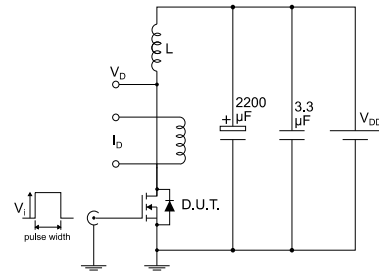

AM01471v1

Figure 17: Unclamped inductive waveform

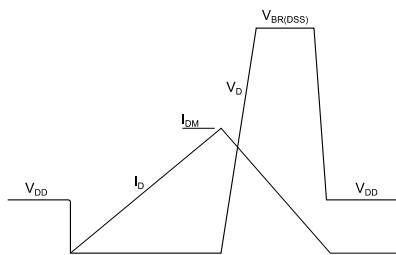

AM01472v1

Figure 18: Switching time waveform

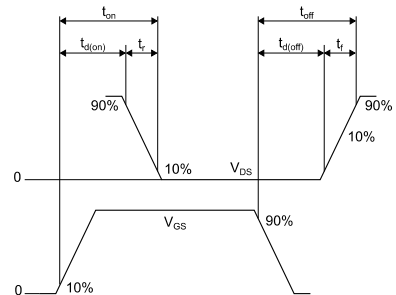

AM01473v1

4 Package information

In order to meet environmental requirements, ST offers these devices in different grades of ECOPACK® packages, depending on their level of environmental compliance. ECOPACK® specifications, grade definitions and product status are available at: www.st.com. ECOPACK® is an ST trademark.

4.1 PoweFLAT 3.3x3.3 package information

Figure 19: PowerFLAT™ 3.3x3.3 package outline

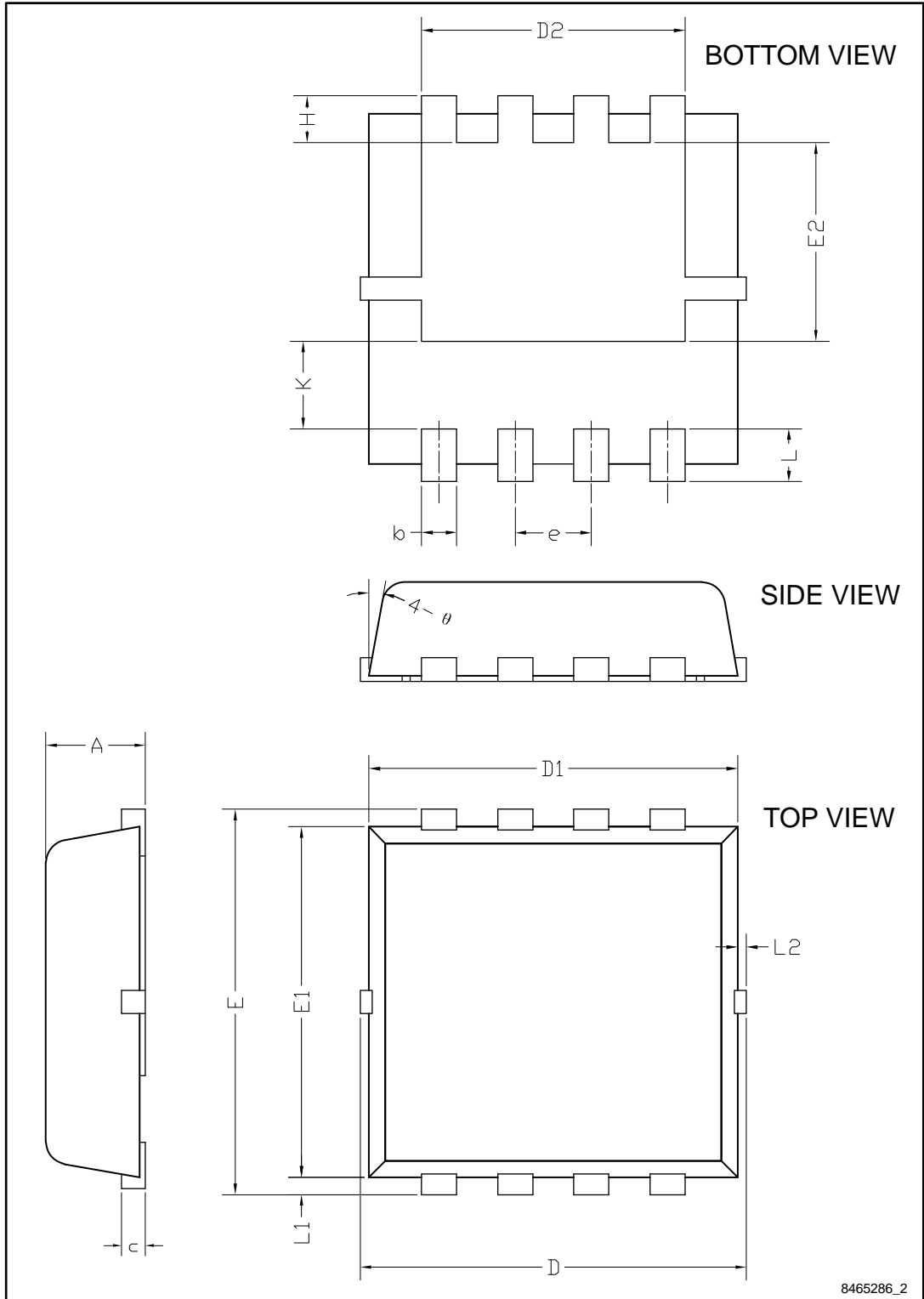
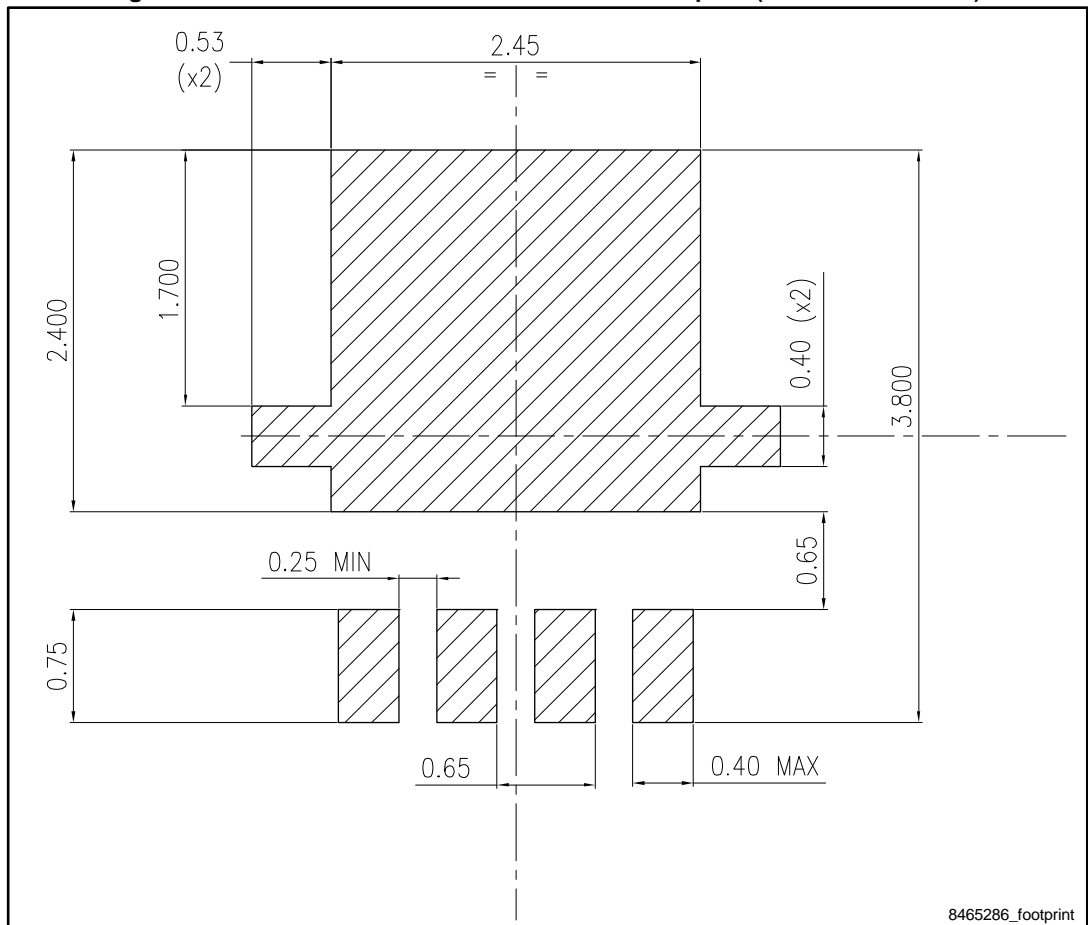

Table 8: PowerFLAT™ 3.3x3.3 package mechanical data

Dim.	mm		
	Min.	Typ.	Max.
A	0.70	0.80	0.90
b	0.25	0.30	0.39
c	0.14	0.15	0.20
D	3.10	3.30	3.50
D1	3.05	3.15	3.25
D2	2.15	2.25	2.35
e	0.55	0.65	0.75
E	3.10	3.30	3.50
E1	2.90	3.00	3.10
E2	1.60	1.70	1.80
H	0.25	0.40	0.55
K	0.65	0.75	0.85
L	0.30	0.45	0.60
L1	0.05	0.15	0.25
L2			0.15
θ	8°	10°	12°

Figure 20: PowerFLAT™ 3.3x3.3 recommended footprint (dimensions in mm)



5 Revision history

Table 9: Document revision history

Date	Revision	Changes
31-Jul-2013	1	First release.
05-Dec-2014	2	<p>Document status promoted from preliminary to production data. Modified title, features and description in cover page. Modified: $R_{DS(on)}$ typical and max values in first page and in <i>Table 4: On/off states</i> Modified: <i>Section 4: Package mechanical data</i> Added <i>Section 2.1: Electrical characteristics (curves)</i>.</p>
02-Nov-2017	3	<p>Datasheet promoted from preliminary data to production data. Modified title, silhouette and features table on cover page. Modified <i>Table 2: "Absolute maximum ratings"</i>, <i>Table 4: "Static"</i> and <i>Table 5: "Dynamic"</i>. Modified <i>Figure 8: "Capacitance variations"</i>, <i>Figure 9: "Normalized gate threshold voltage vs temperature"</i>, <i>Figure 10: "Normalized on-resistance vs temperature"</i>, <i>Figure 11: "Normalized $V_{(BR)DSS}$ vs temperature"</i> and <i>Figure 12: "Source-drain diode forward characteristics"</i>. Updated <i>Section 4: "Package information"</i>. Minor text changes.</p>

IMPORTANT NOTICE – PLEASE READ CAREFULLY

STMicroelectronics NV and its subsidiaries ("ST") reserve the right to make changes, corrections, enhancements, modifications, and improvements to ST products and/or to this document at any time without notice. Purchasers should obtain the latest relevant information on ST products before placing orders. ST products are sold pursuant to ST's terms and conditions of sale in place at the time of order acknowledgement.

Purchasers are solely responsible for the choice, selection, and use of ST products and ST assumes no liability for application assistance or the design of Purchasers' products.

No license, express or implied, to any intellectual property right is granted by ST herein.

Resale of ST products with provisions different from the information set forth herein shall void any warranty granted by ST for such product.

ST and the ST logo are trademarks of ST. All other product or service names are the property of their respective owners.

Information in this document supersedes and replaces information previously supplied in any prior versions of this document.

© 2017 STMicroelectronics – All rights reserved