

Panel Cutout M1:1

Valid for contact arrangement:
05b, 07b, 08a, 12a, 14a

Valid for contact arrangement:
03a, 04a, 05a, 06a, 07a

Alternative 1

Alternative 2

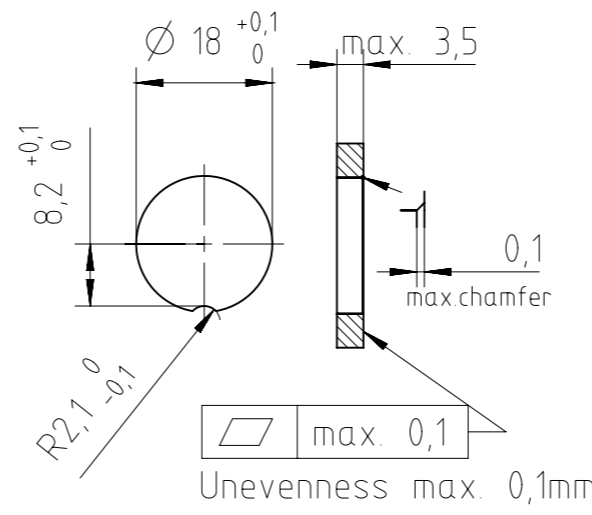
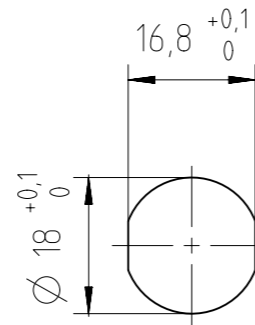
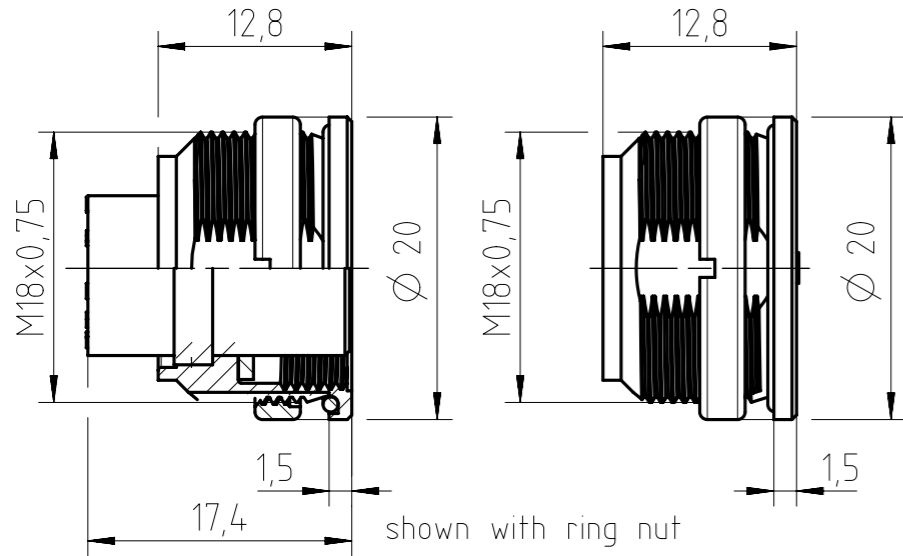

Recommended roughness sealing surface Rz6,3 (Ra0,8)

Number of contacts	Standard	3	4	5	5S	6	7	7	8	12	14
Contact arrangement	DIN EN 61076-2-106	03-a	04-a	05-a	05-b	06-a	07-a	07-b	08-a	12-a	14-a
Contact arrangement	IEC 60130-9 ¹⁾										
Rated voltage ²⁾	IEC 60664-1	300 V (100 V)	300 V (63 V)	100 V (32 V)	300 V (63 V)			100 V (32 V)		150 V (32 V)	
Rated voltage	UL 1977	250 V						60 V			
Rated impulse withstand voltage ²⁾	IEC 60664-1	1500 V (840 V)		1200 V (500 V)	1500 V (840 V)		1200 V (500 V)				
Pollution degree ²⁾	IEC 60664-1	1 (3 ³⁾)									
Installation category	IEC 60664-1	I									
Insulation group	IEC 60664-1	II, 400 ≤ CTI < 600									
Current rating	IEC 60512-5-2 UL 1977	10A/+40°C		7A/+40°C/+104°F				3A/+40°C/+104°F			
Insulation resistance	IEC 60512-3-1	>10 ¹⁰ Ohm ⁴⁾									
Contact resistance	IEC 60512-2-1	<5m Ohm									
Climatic category	IEC 60668-1	40 / 100 / 56									
Temperatur range	IEC 60668-1	-40°C...+100°C / -40°F...+212°F									
salt spray resistance	DIN IEC 60068-2-11	720h									
IP degree	IEC 60529	IP 69K / IP 67 / IP 65 (in mated condition)									
Insertion and withdrawal force	IEC 60512-13-2	25N	30N	35N	50N	55N	60N	50N			
Mechanical operation	IEC 60512-9-1	silver ≥500 mating cycles gold ≥1000 mating cycles									
Housing material		brass and / or zinc die cast, nickel plated									
Dielectric material		thermoplastic									
Contacts		silver or gold plated, please order contacts separately acc. to drawing M-N 02 015 00XX X (3-8pol) or M-N 02 010 0157 X U (12-14pol)									
Termination technique		crimp									
Wire gauge		2-6 pol (exclusive 5S): 0,09-1,0mm ² / 28-18 AWG						0,09-0,25mm ² / 28-24 AWG			
Flamability		UL 94 V0									
locking system	IEC 60130-9 DIN EN 61076-2-106	metal screw coupling; tightening torque 1,0-1,5Nm									

	14 (14-a)	C091 11N014 000 2 U	C091 11N014 009 2 U
	12 (12-a)	C091 11N012 000 2 U	C091 11N012 009 2 U
	8 (08-a)	C091 11N008 000 2 U	C091 11N008 009 2 U
	7 (07-b)	C091 11N107 000 2 U	C091 11N107 009 2 U
	7 (07-a)	C091 11N007 000 2 U	C091 11N007 009 2 U
	6 (06-a)	C091 11N006 000 2 U	C091 11N006 009 2 U
	5 (05-b)	C091 11N105 000 2 U	C091 11N105 009 2 U
	5 (05-a)	C091 11N005 000 2 U	C091 11N005 009 2 U
	4 (04-a)	C091 11N004 000 2 U	C091 11N004 009 2 U
	3 (03-a)	C091 11N003 000 2 U	C091 11N003 009 2 U
Contact arrangement View on mating side	Number of contacts	type-number-crimp with ring nut	type-number-crimp with hex nut SW20

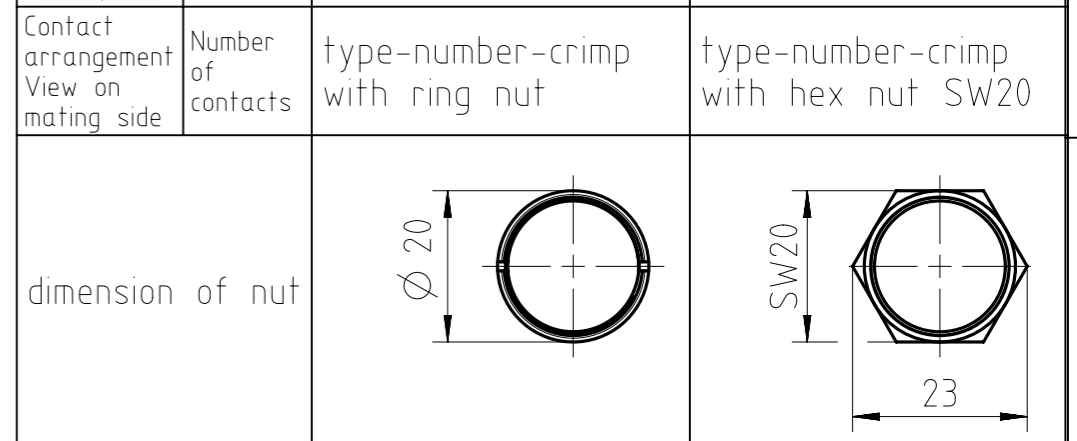

Gewicht (errechnet) / Calc WT:		Zul. Abw./Tolerances:		Maßstab / Scale : 2:1;1:1		A3	
Prüfmaß / Testdimension		ISO 2768-c		DIN / ISO 13715		CUSTOMER DRAWING	
Teileindex / Partindexnumber:		Gez. Drawn		12.03.2020		Gerätedose	
Bagatelle change:		Status		Released		female receptacle	
		Gepr. Checked		30.04.2020			
		MGRIMM					
		Amphenol Tuchel Industrial GmbH		M C091 11NXXX 00X 2 U		Blatt / Sheet 1	
01 20200001		30.04.2020		MCARL		1 Bl.	
Index		Änderung / Description		Datum / Date		Name	
		Ers. f. / Replacement for : M-C091 11NXXX 000 2 U Rev.01					

Copying of this document and giving it to others and the use or communication of the contents thereof, are forbidden without express authority. Offenders are liable to the payment of damages. All rights are reserved in the event of the grant of a patent or the registration of the utility model or design.

¹⁾ Edition 2000-05
²⁾ values in brackets are according to DIN EN 61076-2-106
³⁾ designed acc. pollution degree 2; can be used under pollution degree 3 when the rules of IEC 60644-1 are fulfilled
⁴⁾ under operating conditions >10⁸ Ohm
 All technical data have been measured in a laboratory environment and can be different during practical usage of the product. Any product information is for descriptive usage only and not legally binding; particularly the information does not constitute or provide any legal guaranties. Do not connect or disconnect under load. Metal housing parts shall be securely incorporated to protected ground. Parts according to directive 2002/95/EG (RoHS).

FAI2020-000921
NXM-V01