

IEC Appliance Inlet C14 with Filter, Fuseholder 1- or 2-pole (5x20 mm or 6.3x32 mm), optional Voltage Selector (step switch)



KFC
with voltage selector
3-digits



KFC
without voltage selector



See below:
[Approvals and Compliances](#)

Description

- Panel mount :
Screw-on mounting front side
- 4 Functions :
Appliance Inlet Protection class I , Fuseholder with interchangeable fuse drawer for Fuse-links 5x20 mm or 6.3x32 mm , with or without voltage selector (step switch) , Line filter in standard and medical version
- Quick connect terminals 4.8 x 0.8 mm

Unique Selling Proposition

- Multifunctional power entry module
- Suitable for various fuses
- Highly resistant since fully potted
- V-Lock cord retaining

Characteristics

- All single elements are already wired
- The fuse drawer "Fingergrip" can be removed by hand
- For applications according IEC/UL 62368-1 we recommend variants with bleed resistor
- Suitable for use in medical equipment according to IEC/UL 60601-1 (1 MOOP, 1 MOPP)

Other versions on request

- Variant with notch for V-Lock mating Cordsets

References

Alternative: version without line filter [KEC](#)
 Alternative: Standard version

Weblinks

[pdf data sheet](#), [html datasheet](#), [General Product Information](#), [Approvals](#), [Distributor-Stock-Check](#), [Accessories](#), [Detailed request for product](#)

Newly available variants corresponding to V-Lock mating cordset. The connector is equipped with a notch intended for use with the latching cordset. The cord latching system prevents against accidental removal of the cordset.

Technical Data

Ratings IEC	1 - 10A @ Ta 40 °C / 250 VAC; 50Hz	Appliance inlet/-outlet	C14 acc. to IEC 60320-1, UL 498, CSA C22.2 no. 42 (for cold conditions) pin-temperature 70 °C, 10A, Protection Class I
Ratings UL/CSA	1 - 10A @ Ta 40 °C / 250 VAC; 60Hz	Fuseholder	1-/2-pole, Shocksafe category PC2 acc. to IEC 60127-6, for fuse-links 5 x 20 / 6.3 x 32 mm
Leakage Current	standard < 0.5 mA (250 V / 60Hz) medical < 5 µA (250 V / 60 Hz)	Rated Power Acceptance @ Ta 23 °C	5 x 20: 2.5W (1 pole)/ 2W (2-pole) per pole 6.3 x 32: 3.15W (1 pole)/ 2.5W (2-pole) per pole
Dielectric Strength	> 1.7 kVDC between L-N > 2.7 kVDC between L/N-PE Test voltage (2 sec)	Power Acceptance @ Ta > 23°C	Admissible power acceptance at higher ambient temperature see derating curves
Allowable Operation Temperature	-25 °C to 85 °C	Voltage Selector	optional, step, 3 pos.
Climatic Category	25/085/21 acc. to IEC 60068-1	Line Filter	Standard and Medical Version, IEC 60939, UL 1283, CSA C22.2 no. 8 Technical Details
IP-Protection	front side IP40 acc. to IEC 60529	MTBF	> 1'700'000h acc. to MIL-HB-217 F
Protection Class	Suitable for appliances with protection class I acc. to IEC 61140		
Terminal	Quick connect terminals 4.8 x 0.8 mm		
Panel Thickness S	Screw: max 8 mm Mounting screw torque max 0.5 Nm		
Material: Housing	Thermoplastic, black, UL 94V-0		

Approvals and Compliances



Detailed information on product approvals, code requirements, usage instructions and detailed test conditions can be looked up in [Details about Approvals](#)

SCHURTER products are designed for use in industrial environments. They have approvals from independent testing bodies according to national and international standards. Products with specific characteristics and requirements such as required in the automotive sector according to IATF 16949, medical technology according to ISO 13485 or in the aerospace industry can be offered exclusively with customer-specific, individual agreements by SCHURTER.

Approvals









The approval mark is used by the testing authorities to certify compliance with the safety requirements placed on electronic products.

Approval Reference Type: KFC

Approval Logo	Certificates	Certification Body	Description
	VDE Approvals	VDE	Certificate Number: 40004665 (FKO, FKP, FKQ, FKR)
	UL Approvals	UL	UL File Number: E72928 (FKO, FKP, FKQ, FKR)
	CQC Approvals	CQC	CQC Certificate Number: CQC19001212148



Product standards

Product standards that are referenced

Organization	Design	Standard	Description
	Designed according to	IEC 60320-1	Appliance couplers for household and similar general purposes
	Designed according to	IEC 60939	Passive filters for suppressing electromagnetic interference
	Designed according to	IEC 60127-6	Miniature fuses. Part 6. Fuse-holders for miniature fuse-links
	Designed according to	IEC 61058-1	Switches for appliances. Part 1. General requirements
	Designed according to	UL 498	Standard for Attachment Plugs and Receptacles
	Designed according to	UL 1283	Electromagnetic interference filters
	Designed according to	CSA C22.2 no. 42	General Use Receptacles, Attachment Plugs, and Similar Wiring Devices
	Designed according to	CSA C22.2 no. 8	Electromagnetic interference (EMI) filters









Application standards

Application standards where the product can be used

Organization	Design	Standard	Description
	Designed for applications acc.	IEC/UL 62368-1	Audio/video, information and communication technology equipment - Part 1: Safety requirements
	Designed for applications acc.	IEC 60601-1	Medical electrical equipment - Part 1: General requirements for basic safety and essential performance
	Designed for applications acc.	IEC 60335-1	Safety of electrical appliances for household and similar purposes. Meets the requirements for appliances in unattended use. This includes the enhanced requirements of glow wire tests acc. to IEC 60695-2-11 or -12 & -13.

Compliances

The product complies with following Guide Lines

Identification	Details	Initiator	Description
	CE declaration of conformity	SCHURTER AG	The CE marking declares that the product complies with the applicable requirements laid down in the harmonisation of Community legislation on its affixing in accordance with EU Regulation 765/2008.
	UKCA declaration of conformity	SCHURTER AG	The UKCA marking declares that the product complies with the applicable requirements laid down in the British Amendment of Regulation (EC) 765/2008.
	RoHS	SCHURTER AG	Directive RoHS 2011/65/EU, Amendment (EU) 2015/863
	China RoHS	SCHURTER AG	The law SJ / T 11363-2006 (China RoHS) has been in force since 1 March 2007. It is similar to the EU directive RoHS.
	REACH	SCHURTER AG	On 1 June 2007, Regulation (EC) No 1907/2006 on the Registration, Evaluation, Authorization and Restriction of Chemicals 1 (abbreviated as "REACH") entered into force.
		SCHURTER AG	V-Lock system are based on a matching plug-dose combination. The connector is equipped with a notch intended for use with the latching cordset. The cord latching system prevents against accidental removal of the cordset.
	White Paper Glow wire test	SCHURTER AG	Meets the requirements of IEC 60335-1 for appliances in unattended use. This includes the enhanced requirements of glow wire tests acc. to IEC 60695-2-11 or -12 & -13.
	Medical Equipment	SCHURTER AG	Suitable for use in medical equipment according to IEC/UL 60601-1 (1 MOPP, 1 MOPP)

Dimension [mm]

KFC

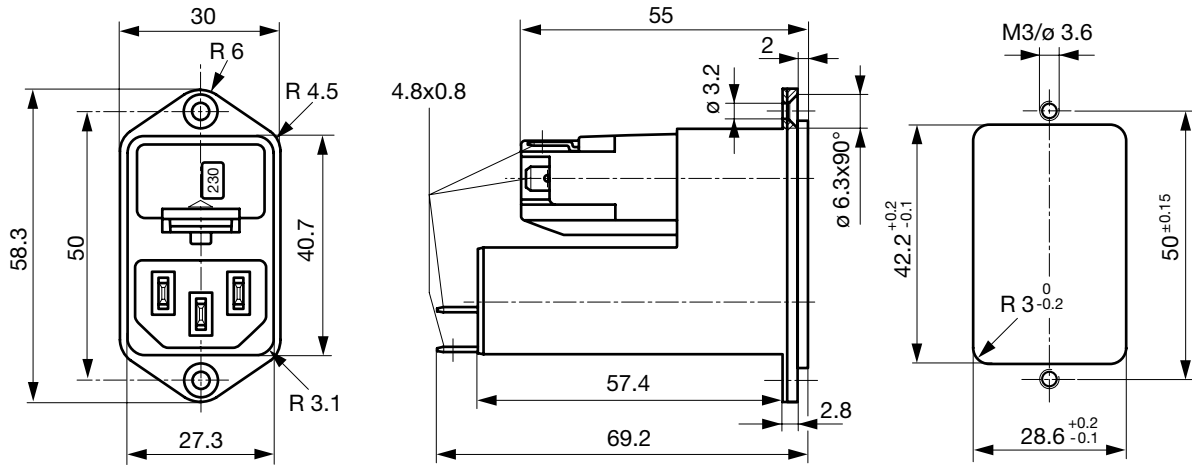

Technical Data of Filter-Components

Rated Current [A]	Filter-Type	Inductances L [mH]	Capacitance CX [nF]	Capacitance CY [nF]	R [MΩ]
1	Standard version	2 x 10	68	2.2	-
2	Standard version	2 x 4	68	2.2	-
4	Standard version	2 x 1.5	68	2.2	-
6	Standard version	2 x 0.8	68	2.2	-
10	Standard version	2 x 0.3	68	2.2	-
1	Medical Version (M5)	2 x 10	68	-	1
2	Medical Version (M5)	2 x 4	68	-	1
4	Medical Version (M5)	2 x 1.5	68	-	1
6	Medical Version (M5)	2 x 0.8	68	-	1
10	Medical Version (M5)	2 x 0.3	68	-	1
10	Standard and Medical Version	2 x 0.3	68	2.2	1

Diagrams

Standard version
with voltage selector

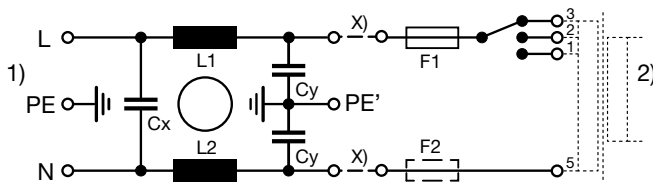

Medical Version (M5)
with voltage selector

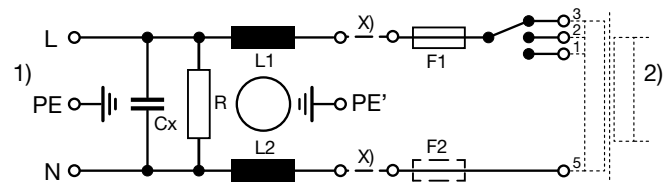

x) external connection to be made by the customer

x) external connection to be made by the customer

- 1) Line
- 2) Load

- 1) Line
- 2) Load

Derating Curves

Fuses

5 x 20 mm (1-pole)

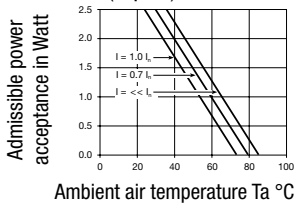

Fuses

5 x 20 mm (2-pole, per pole)

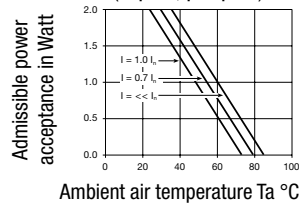

Fuses

6.3 x 32 mm (1-pole)

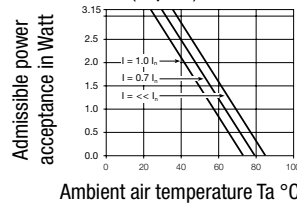

Fuses

6.3 x 32 mm (2-pole, per pole)

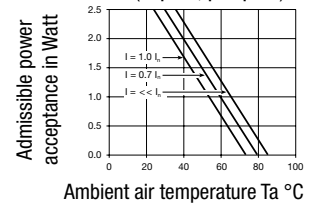

Attenuation Loss

--- 50Ω differential mode ___ 50Ω common mode

Standard version

1 A

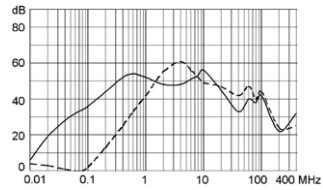

2 A

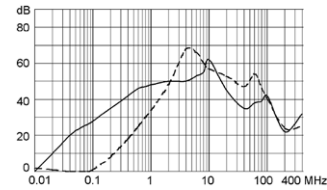

4 A

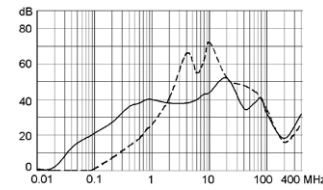

6 A

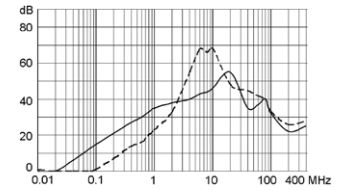

10 A

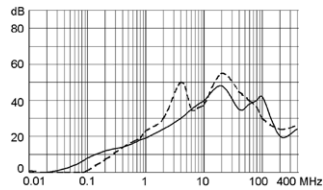

Medical version (M5)

1 A

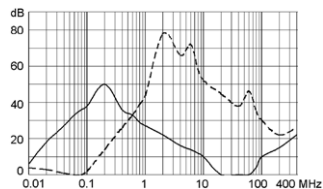

2 A

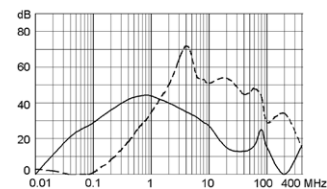

4 A

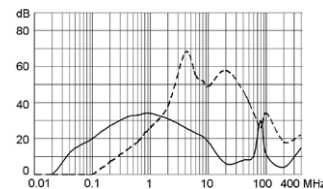

6 A

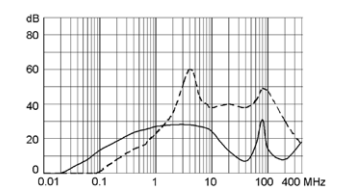

10 A

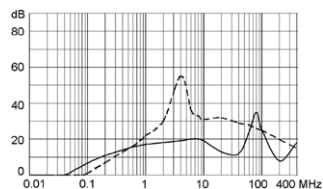

All Variants

Rated Current [A]	Filter-Type	Fuseholder	Voltage Selector	V-Lock	Order Number
1	Standard version	1-pole	-		4303.5011
2	Standard version	1-pole	-		4303.5012
4	Standard version	1-pole	-		4303.5013
6	Standard version	1-pole	-		4303.5014
10	Standard version	1-pole	-		4303.5015

Rated Current [A]	Filter-Type	Fuseholder	Voltage Selector	V-Lock	Order Number
1	Standard version	1-pole	3 pos.		4303.5031
2	Standard version	1-pole	3 pos.		4303.5032
4	Standard version	1-pole	3 pos.		4303.5033
6	Standard version	1-pole	3 pos.		4303.5034
10	Standard version	1-pole	3 pos.		4303.5035
1	Standard version	2-pole	-		4303.5001
2	Standard version	2-pole	-		4303.5002
4	Standard version	2-pole	-		4303.5003
6	Standard version	2-pole	-		4303.5004
10	Standard version	2-pole	-		4303.5005
1	Standard version	2-pole	3 pos.		4303.5021
2	Standard version	2-pole	3 pos.		4303.5022
4	Standard version	2-pole	3 pos.		4303.5023
6	Standard version	2-pole	3 pos.		4303.5024
10	Standard version	2-pole	3 pos.		4303.5025
1	Medical Version (M5)	2-pole	3 pos.		4303.5221
2	Medical Version (M5)	2-pole	3 pos.		4303.5223
4	Medical Version (M5)	2-pole	3 pos.		4303.5225
6	Medical Version (M5)	2-pole	3 pos.		4303.5227
10	Medical Version (M5)	2-pole	3 pos.	●	4303.5209.21
10	Medical Version (M5)	2-pole	3 pos.		4303.5229

Most Popular.

Availability for all products can be searched real-time: <https://www.schurter.com/en/Stock-Check/Stock-Check-SCHURTER>

The fuse drawer is not included and must be ordered separately (see required accessory).

Packaging unit 10 Pcs

Required Accessory

Description

Fusedrawer 3

Fusedrawer for Fuse Links 5x20 mm resp. 6.3x32 mm



Fingergrip, 5 x 20, 2-pole, Voltage Selector	4303.2014.00
Fingergrip, 5 x 20, 2-pole, Voltage Selector, 100, 120, 220, 240	4303.2014.01
Fingergrip, 5 x 20, 2-pole, Voltage Selector, 110, 150, 220	4303.2014.02
Fingergrip, 5 x 20, 2-pole, Voltage Selector, 110, 220	4303.2014.03

...

Accessories

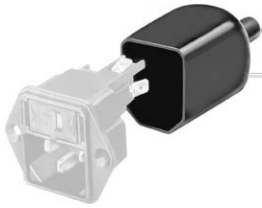

Assorted Covers
Rear Cover

0859.0072



RC320
Rear Cover for Power Entry Module



Cord retaining kits
Cord retaining strain relief

Flat head, A

4700.0001

Mating Outlets/Connectors

Category / Description

[Appliance Outlet Overview complete](#)



4787, Mounting: Screw-on mounting, Appliance Outlet: IEC Solder terminals, 10 A, Suitable for appliances with protection class I

4787

4788, Mounting: Snap-in version, Appliance Outlet: IEC Solder / Quick Connect, 10 A, Suitable for appliances with protection class I

4788

IEC Appliance Outlet F or H, Screw-on Mounting, Front Side, Solder, PCB or Quick-connect Terminal

5091

[Connector Overview complete](#)



4782 Mounting: Power Cord, 3 x 1 mm² / 3 x 18 AWG, Cable, Connector: IEC C13

4782

4785 Mounting: Power Cord, 3 x 1 mm² / 3 x 18 AWG, Cable, Connector: IEC C13

4785

4300-06 Mounting: Power Cord, 3 x 1 mm² / 3 x 18 AWG, Cable, Connector: IEC C13

4300-06

4781 Mounting: Power Cord, Cable, Connector: IEC C15

4781

4784 Mounting: Power Cord, 3 x 1 mm² / 3 x 18 AWG, Cable, Connector: IEC C15

4784

...

Mating Outlets/Connectors shuttered



[Connector Overview complete](#)

4783 Mounting: Power Cord, 3 x 1 mm² / 3 x 18 AWG, Cable, Connector: IEC C13

4783



[Power Cord Overview complete](#)

VAC13KS, Overview, V-Lock cord retaining, diverse Connector IEC C13, diverse, black

[VAC13KS](#)