

Cord retaining strain relief



See below:
[Approvals and Compliances](#)

Description

- Front Panel :
 Screw-on from front side
- 1 Function :
 Protection against accidental disconnection of the plug

Weblinks

[pdf data sheet](#), [html datasheet](#), [General Product Information](#), [Approvals](#), [Distributor-Stock-Check](#), [Accessories](#), [Detailed request for product](#)

For protection against loosening or accidental disconnection of the plug connector. Can also be mounted later. The correct kit type respectively the corresponding Order No. for each combination of fixed and free components is shown in the selection chart.

Horizontal flanged components are secured to the panel using the kit supplied. Vertical flanged or snap-in components require additional drilling for the cord retaining kit as shown in the diagrams below.

The kits with the part number 4700.00XX consist of:

- 1 Stainless steel retaining clip
- 2 Nickel plated brass pillars
- 2 Nickel plated brass nuts
- 2 Nickel plated beryllium copper crinkle washers



Approvals and Compliances

Detailed information on product approvals, code requirements, usage instructions and detailed test conditions can be looked up in [Details about Approvals](#)

SCHURTER products are designed for use in industrial environments. They have approvals from independent testing bodies according to national and international standards. Products with specific characteristics and requirements such as required in the automotive sector according to IATF 16949, medical technology according to ISO 13485 or in the aerospace industry can be offered exclusively with customer-specific, individual agreements by SCHURTER.





Application standards

Application standards where the product can be used

Organization	Design	Standard	Description
	Designed for applications acc.	IEC/UL 62368-1	Audio/video, information and communication technology equipment - Part 1: Safety requirements
	Designed for applications acc.	IEC 60601-1	Medical electrical equipment - Part 1: General requirements for basic safety and essential performance

Compliances

The product complies with following Guide Lines

Identification	Details	Initiator	Description
	RoHS	SCHURTER AG	Directive RoHS 2011/65/EU, Amendment (EU) 2015/863
	China RoHS	SCHURTER AG	The law SJ / T 11363-2006 (China RoHS) has been in force since 1 March 2007. It is similar to the EU directive RoHS.
	REACH	SCHURTER AG	On 1 June 2007, Regulation (EC) No 1907/2006 on the Registration, Evaluation, Authorization and Restriction of Chemicals 1 (abbreviated as "REACH") entered into force.
	Medical Equipment	SCHURTER AG	Suitable for use in medical equipment according to IEC/UL 60601-1 (1 MOOP, 1 MOPP)

Dimension [mm]

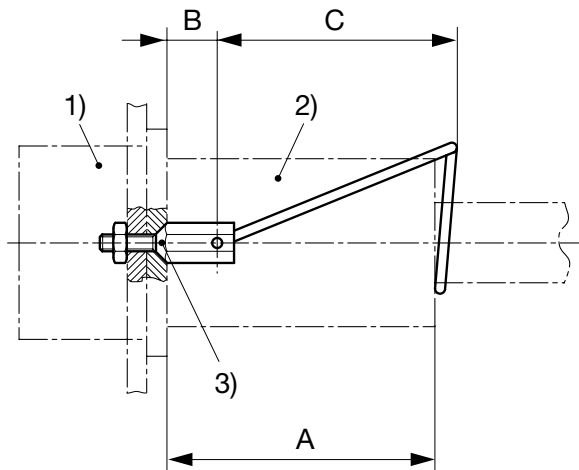

(Details see overview table and table of variants)

- 1) Inlet/Outlet 2) Plug/Connector 3) Design

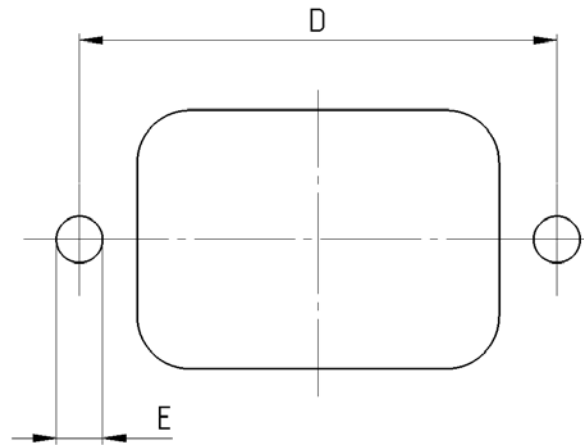

Type	Snap-in Mounting	Screw-on Mounting	Appliance inlet/outlet		Outlet	Inlet	Panel Thickness	Cord plug /connector						
			Mounting from Frontside	Mounting from Rearside				Type	4781	4782	4795	4732	4735	4796
								Dimension A	48	48	38	39	43	40
								Plug	•	•	•	•	•	•
								Connector	•	•	•			
1621		•	•			•								K
4707		•	•			•			B	B				
4721		•	•			•								D
4721		•	•			•								F
4723	•		•			•								E
4723	•		•			•								G
4752	•		•			•								E
4752	•		•			•								G
4754	•		•			•								E
4754	•		•			•	•							G
4754	•		•			•			H	H				
4758	•		•			•								E
4758	•		•			•	•							G
4758	•		•			•	•		H	H				
4793		•	•			•								L
4797	•		•			•								
4797		•	•			•								L
4797		•	•			•								J
4798		•	•			•								K
5110	•		•			•			A	A				
5110		•	•			•			C	C				
5120	•		•			•			G	G				
5120		•	•			•			G	G				
5120		•	•			•	> 5 mm		E	E				
5120		•	•			•	< 3 mm		G	G				
5150	•		•			•			G	G				
5150		•	•			•			G	G				
5150		•	•			•	> 5 mm		E	E				
5150		•	•			•	< 3 mm		G	G				
5130	•		•			•								L
5130		•	•			•								L
5130		•	•			•	< 3 mm							L
5200		•	•			•			B	B				
5216		•	•			•								L
5220		•	•			•			B	B				
6100	•		•			•			A	A				
6100		•	•			•			C	C				
6110	•		•			•			A	A				
6110		•	•			•			C	C				
6135	•		•			•			A	A				
6200	•		•			•			A	A				
6200		•	•			•			B	B				
6220	•		•			•			A	A				
6220		•	•			•			B	B				
6600	•		•			•								E
6600	•		•			•								G
6600		•	•			•								D
6600		•	•			•								F
6610	•		•			•								E
6610	•		•			•								G
0723		•	•			•								J
C20F	•		•			•								L
C20F		•	•			•								L
C20F		•	•			•	< 3 mm							L
CD	•	•	•			•			A	A				
CE	•	•	•			•			A	A				
CG	•	•	•			•			A	A				
DA22		•	•			•			H	H				
DC11	•		•			•			A	A				
DC11		•	•			•			B	B				
DC12	•		•			•			A	A				
DC12		•	•			•			B	B				
DC12		•	•			•			A	A				
DC21		•	•			•			G	G				
DC22		•	•			•			H	H				
DD11		•	•			•			A	A				
DD11		•	•			•	< 3 mm		A	A				
DD12		•	•			•			A	A				
DD12		•	•			•	< 3 mm		A	A				
DD21		•	•			•	< 3 mm		A	A				
DD22		•	•			•	< 3 mm		A	A				

Type	Snap-in Mounting	Screw-on Mounting	Appliance inlet /outlet		Outlet	Inlet	Panel Thickness	Cord plug /connector						
			Mounting from Frontside	Mounting from Rearside				Type	4781	4782	4795	4732	4735	4796
								Dimension A	48	48	38	39	43	40
								Plug				•	•	•
								Connector	•	•	•			
EC11		•	•			•						M		
EC12		•			•							M		
EF11		•			•							M		
EF12		•			•							M		
Felcom 54	•		•			•		A	A					
Felcom 54	•		•			•						E		
Felcom 54	•		•			•							G	
Felcom 64	•		•			•		A	A					
Felcom 64	•		•			•						E		
Felcom 64	•		•			•							G	
KD	•	•	•			•		A	A					
KE	•	•	•			•		A	A					
KEA	•		•			•		A	A					
KEA		•	•			•		B	B					
KEB1	•		•			•		A	A					
KEB1		•	•			•		B	B					
KEB2	•	•	•			•		A	A					
KFC	•	•	•			•		A	A					
KFA	•		•			•		A	A					
KFA		•	•			•		B	B					
KFA		•	•		•	•		A	A					
KFB1		•	•			•		B	B					
KFB2	•	•	•			•		A	A					
KFC	•	•	•			•		A	A					
KFS		•	•			•		C	C					
KFX		•	•			•		C	C					
KG		•	•			•		A	A					
KM	•		•			•		A	A					

All Variants

Kit	Type	B [mm]	C [mm]	D [mm]	E [mm]	Packaging unit [PCS]	Order Number
-	Flat head	5	36	36	3.4	50	0888.0005
-	Flat head	11.5	36	36	3.4	50	0888.0016
-	Countersunk	3	35	36	3.4	50	0888.0001
-	Countersunk	3.5	36	36	3.4	50	0888.0004
-	Countersunk	9	36	36	3.4	50	0888.0015
-	Countersunk	6.5	36	36	3.4	50	0888.0017
A	Flat head	8	45	40	3.4	100	4700.0001
B	Countersunk	8	45	36	3.4	100	4700.0002
C	Countersunk	6.5	45	40	3.4	100	4700.0003
D	Countersunk	2.5	40	40	3.4	100	4700.0004
E	Flat head	4.5	40	42	3.4	100	4700.0005
F	Countersunk	2.5	45	40	3.4	100	4700.0006
G	Flat head	4.5	45	40	3.4	100	4700.0007
H	Flat head	5.5	45	39	3.4	100	4700.0008
J	Countersunk	6.5	37	45	3.4	100	4700.0009
K	Countersunk	5	37	42	3.4	100	4700.0010
L	Flat head	5.5	37	42	3.4	100	4700.0011
M	Flat head	5.5	40	42	3.4	100	4700.0012

Most Popular.

Availability for all products can be searched real-time: <https://www.schurter.com/en/Stock-Check/Stock-Check-SCHURTER>