



# 92x92x38 mm

San Ace 92W 9WL type   

DC  
Splash Proof Fan 92 mm sq.

## General Specifications

- Material ..... Frame: Aluminum (Black coating), Impeller: Plastic (Flammability: UL 94V-1)
- Expected life ..... See the table below. (L10 life: 90% survival rate for continuous operation in indoor free air at 60°C, rated voltage)  
Expected life at 40°C is for reference only.
- Motor protection function ..... Locked rotor burnout protection, Reverse polarity protection  
For details, please refer to p. 599.
- Dielectric strength ..... 50/60 Hz, 500 VAC, for 1 minute (between lead wire conductors and frame)
- Insulation resistance ..... 10 MΩ or more with a 500 VDC megger (between lead wire conductors and frame)
- Sound pressure level (SPL) ..... At 1 m away from the air inlet
- Storage temperature ..... -30 to +70°C (Non-condensing)
- Lead wire ..... ⊕Red ⊖Black (Sensor) Yellow (Control) Brown
- Mass ..... 300 g
- Ingress protection ..... IP68

## Specifications

The models listed below **have pulse sensors with PWM control function.**

Model no.	Rated voltage [V]	Operating voltage range [V]	PWM duty cycle* [%]	Rated current [A]	Rated input [W]	Rated speed [min <sup>-1</sup> ]	Max. airflow [m <sup>3</sup> /min] [CFM]	Max. static pressure [Pa] [inchH <sub>2</sub> O]	SPL [dB (A)]	Operating temperature [°C]	Expected life [h]
9WL0912P1H001	12	10.2 to 13.2	100	1.9	22.8	9000	3.7 130.6	430 1.72	61	-20 to +70	100000/60°C (135000/40°C)
			20	0.13	1.56	2700	1.11 39.1	48.0 0.19	30		
9WL0912P1F001	12	10.2 to 13.2	100	0.95	11.4	7000	2.9 102.4	263 1.05	55		
			20	0.1	1.2	2000	0.83 29.3	26.3 0.1	22		
9WL0924P1H001	24	20.4 to 26.4	100	0.95	22.8	9000	3.7 130.6	430 1.72	61		
			20	0.07	1.68	2700	1.11 39.1	48.0 0.19	30		
9WL0924P1F001	24	20.4 to 26.4	100	0.5	12	7000	2.9 102.4	263 1.05	55		
			20	0.06	1.44	2000	0.83 29.3	26.3 0.1	22		
9WL0948P1H601	48	40.8 to 52.8	100	0.48	23.04	9000	3.7 130.6	430 1.72	61		
			20	0.05	2.4	2700	1.11 39.1	48.0 0.19	30		
9WL0948P1F601	48	40.8 to 52.8	100	0.24	11.52	7000	2.9 102.4	263 1.05	55		
			20	0.05	2.4	2000	0.83 29.3	26.3 0.1	22		

\* PWM input frequency is 25 kHz; models without specifications at 0% PWM duty cycle have zero fan speed at 0%.

Note: Sensor and control options are available for selection. Refer to the table on p. 638.

## Airflow - Static Pressure Characteristics / PWM Duty - Speed Characteristics Example

**9WL0912P1H001** With pulse sensor with PWM control function

PWM duty cycle

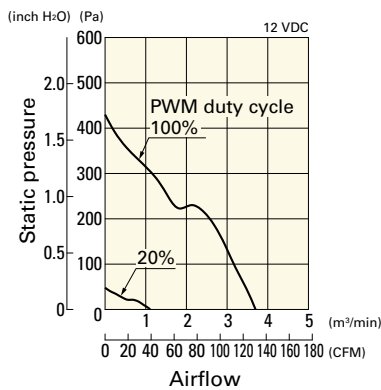

Operating voltage range

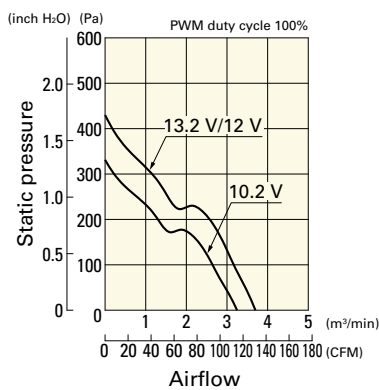

PWM duty - Speed characteristics example

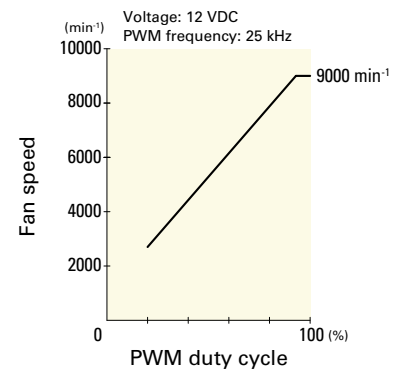

# Airflow - Static Pressure Characteristics / PWM Duty - Speed Characteristics Example

**9WL0912P1F001** With pulse sensor with PWM control function

PWM duty cycle

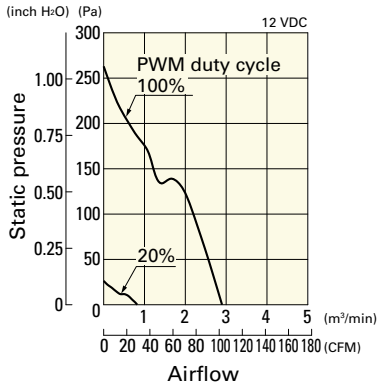

Operating voltage range

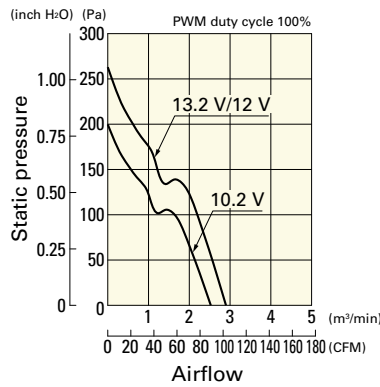

PWM duty - Speed characteristics example

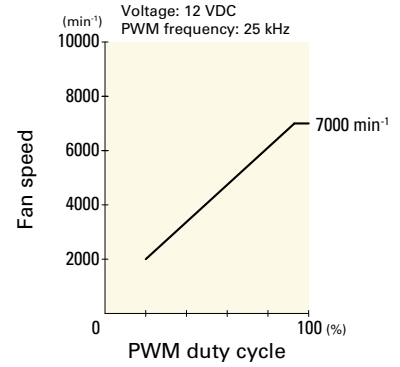

**9WL0924P1H001** With pulse sensor with PWM control function

PWM duty cycle

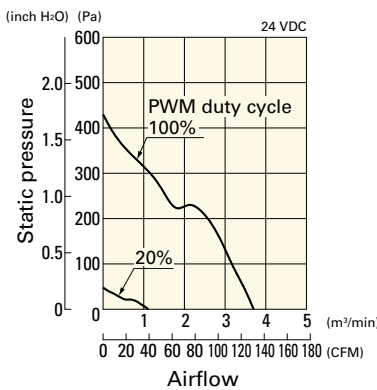

Operating voltage range

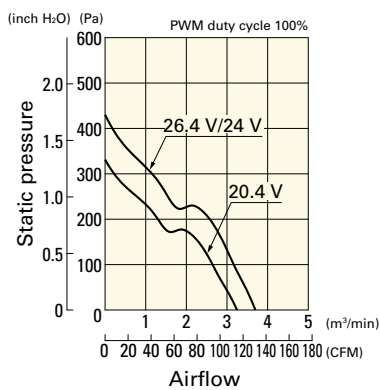

PWM duty - Speed characteristics example

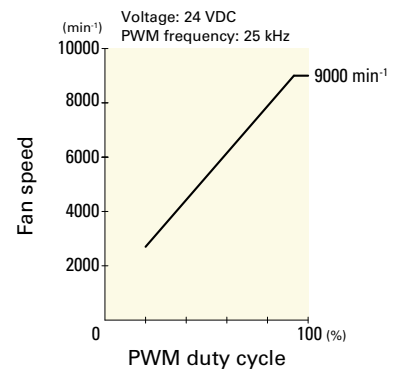

**9WL0924P1F001** With pulse sensor with PWM control function

PWM duty cycle

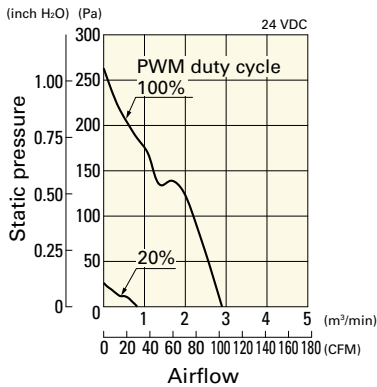

Operating voltage range

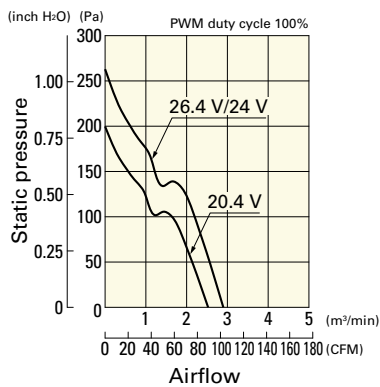

PWM duty - Speed characteristics example

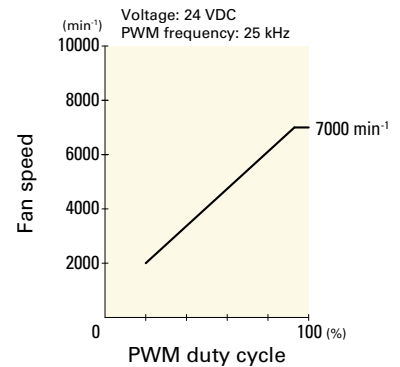

**9WL0948P1H601** With pulse sensor with PWM control function

PWM duty cycle

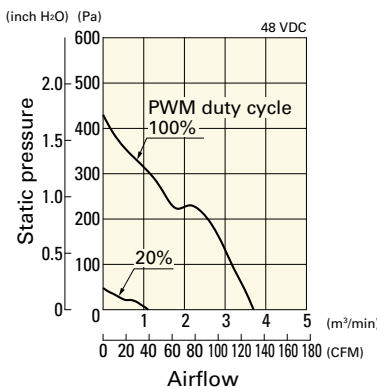

Operating voltage range

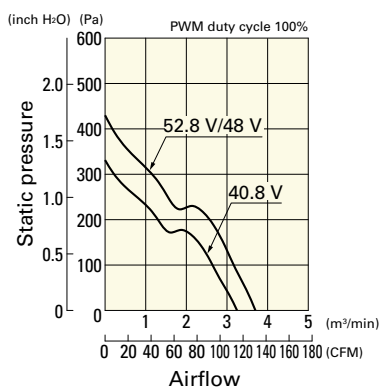

PWM duty - Speed characteristics example

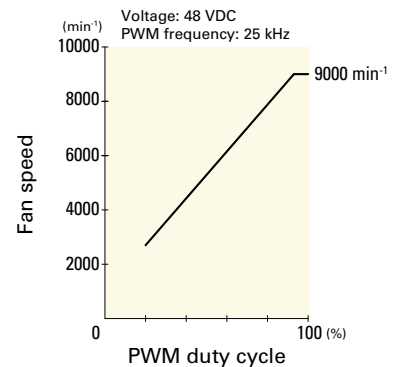

DC  
Splash Proof Fan 92 mm sq.

## Airflow - Static Pressure Characteristics / PWM Duty - Speed Characteristics Example

**9WL0948P1F601** With pulse sensor with PWM control function

PWM duty cycle

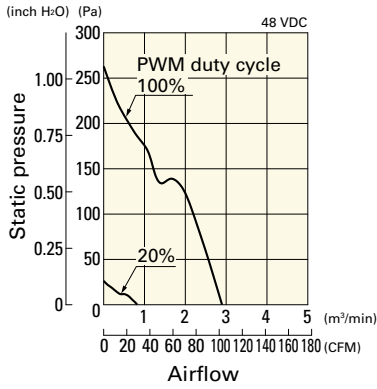

Operating voltage range

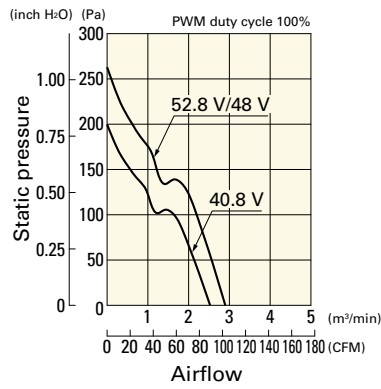

PWM duty - Speed characteristics example

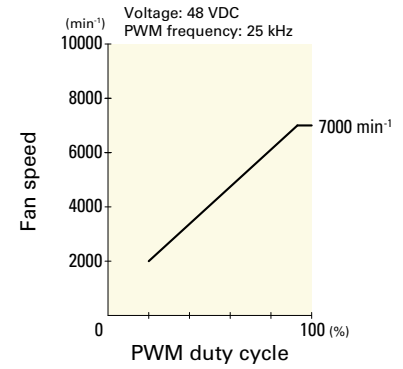

## Dimensions (unit: mm)

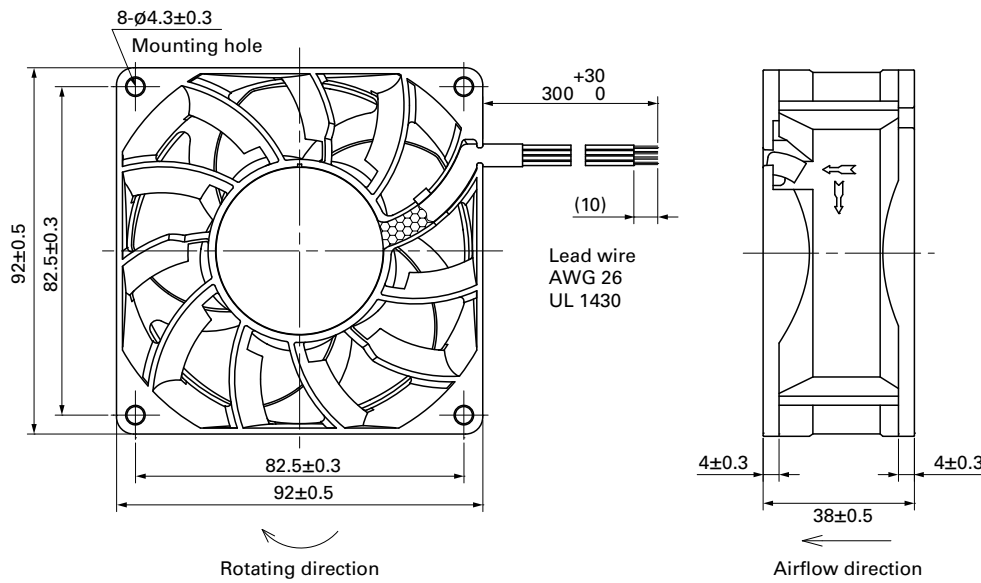

## Reference Dimensions of Mounting Holes and Vent Opening (unit: mm)

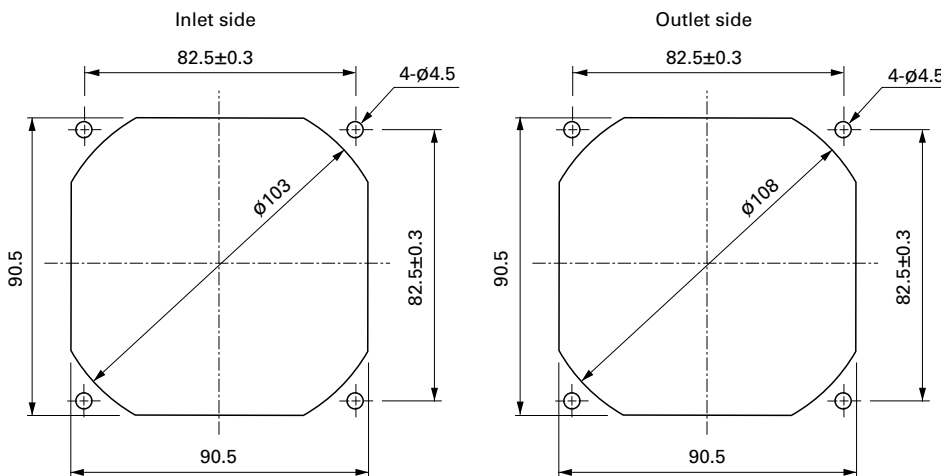

## Options

Finger guards

page: p. 584

Model no.: 109-099E, 109-099H, 109-099C

Resin finger guards

page: p. 591

Model no.: 109-1001G