



BCM62B

PNP/PNP matched double transistor

Rev. 02 — 28 August 2009

Product data sheet

1. Product profile

1.1 General description

PNP/PNP matched double transistor in a SOT143B small Surface-Mounted Device (SMD) plastic package. Matched version of BCV62.

NPN/NPN equivalent: BCM61B

1.2 Features

- Current gain matching

1.3 Applications

- Current mirror
- Differential amplifier

1.4 Quick reference data

Table 1. Quick reference data

| Symbol | Parameter | Conditions | Min | Typ | Max | Unit |
|---------------------------|---------------------------|--|-------|-----|------|------|
| Per transistor TR1 | | | | | | |
| V_{CEO} | collector-emitter voltage | open base | - | - | -45 | V |
| h_{FE} | DC current gain | $V_{CE} = -5\text{ V};$ $I_C = -2\text{ mA}$ | 200 | 290 | 450 | |
| Per transistor | | | | | | |
| I_C | collector current | | - | - | -100 | mA |
| Per device | | | | | | |
| I_{C1}/I_{E2} | current matching | $V_{CE1} = -5\text{ V};$ $I_{E2} = 0.5\text{ mA};$ $T_{amb} \leq 25\text{ °C}$ | [1] 1 | 1.1 | 1.2 | |

[1] Device mounted on an FR4 Printed-Circuit Board (PCB), single-sided copper, tin-plated and standard footprint.

2. Pinning information

Table 2. Pinning

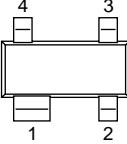
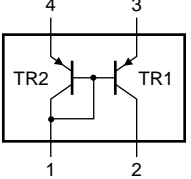
| Pin | Description | Simplified outline | Symbol |
|-----|---------------------------------|---|---|
| 1 | collector TR2, base TR1 and TR2 |  |  |
| 2 | collector TR1 | | |
| 3 | emitter TR1 | | |
| 4 | emitter TR2 | | |

006aaa843

3. Ordering information

Table 3. Ordering information

| Type number | Package | | |
|-------------|---------|--|---------|
| | Name | Description | Version |
| BCM62B | - | plastic surface-mounted package; 4 leads | SOT143B |

4. Marking

Table 4. Marking codes

| Type number | Marking code ^[1] |
|-------------|-----------------------------|
| BCM62B | *AD |

- [1] * = -: made in Hong Kong
 * = p: made in Hong Kong
 * = t: made in Malaysia
 * = W: made in China

5. Limiting values

Table 5. Limiting values

In accordance with the Absolute Maximum Rating System (IEC 60134).

| Symbol | Parameter | Conditions | Min | Max | Unit |
|---------------------------|---------------------------|----------------------------------|-------|------|------|
| Per transistor TR1 | | | | | |
| V_{CBO} | collector-base voltage | open emitter | - | -50 | V |
| V_{CEO} | collector-emitter voltage | open base | - | -45 | V |
| Per transistor | | | | | |
| V_{EBS} | emitter-base voltage | $V_{CB} = 0$ V | - | -5 | V |
| I_C | collector current | | - | -100 | mA |
| I_{CM} | peak collector current | single pulse; $t_p \leq 1$ ms | - | -200 | mA |
| P_{tot} | total power dissipation | $T_{amb} \leq 25$ °C | [1] - | 220 | mW |
| Per device | | | | | |
| P_{tot} | total power dissipation | $T_{amb} \leq 25$ °C | [1] - | 390 | mW |
| T_j | junction temperature | | - | 150 | °C |
| T_{amb} | ambient temperature | | -65 | +150 | °C |
| T_{stg} | storage temperature | | -65 | +150 | °C |

[1] Device mounted on an FR4 PCB, single-sided copper, tin-plated and standard footprint.

6. Thermal characteristics

Table 6. Thermal characteristics

| Symbol | Parameter | Conditions | Min | Typ | Max | Unit |
|-----------------------|---|-------------|-------|-----|-----|------|
| Per transistor | | | | | | |
| $R_{th(j-a)}$ | thermal resistance from junction to ambient | in free air | [1] - | - | 568 | K/W |
| Per device | | | | | | |
| $R_{th(j-a)}$ | thermal resistance from junction to ambient | in free air | [1] - | - | 321 | K/W |

[1] Device mounted on an FR4 PCB, single-sided copper, tin-plated and standard footprint.

7. Characteristics

Table 7. Characteristics

$T_{amb} = 25\text{ °C}$ unless otherwise specified.

| Symbol | Parameter | Conditions | Min | Typ | Max | Unit | |
|---------------------------|--------------------------------------|---|-----|------|------|---------------|----|
| Per transistor TR1 | | | | | | | |
| I_{CBO} | collector-base cut-off current | $V_{CB} = -30\text{ V};$ $I_E = 0\text{ A}$ | - | - | -15 | nA | |
| | | $V_{CB} = -30\text{ V};$ $I_E = 0\text{ A};$ $T_j = 150\text{ °C}$ | - | - | -5 | μA | |
| I_{EBO} | emitter-base cut-off current | $V_{EB} = -5\text{ V};$ $I_C = 0\text{ A}$ | - | - | -100 | nA | |
| h_{FE} | DC current gain | $V_{CE} = -5\text{ V};$ $I_C = -10\text{ }\mu\text{A}$ | - | 250 | - | | |
| | | $V_{CE} = -5\text{ V};$ $I_C = -100\text{ }\mu\text{A}$ | 100 | - | - | | |
| | | $V_{CE} = -5\text{ V};$ $I_C = -2\text{ mA}$ | 200 | 290 | 450 | | |
| V_{CEsat} | collector-emitter saturation voltage | $I_C = -10\text{ mA};$ $I_B = -0.5\text{ mA}$ | - | -50 | -200 | mV | |
| | | $I_C = -100\text{ mA};$ $I_B = -5\text{ mA}$ | - | -200 | -400 | mV | |
| V_{BEsat} | base-emitter saturation voltage | $I_C = -10\text{ mA};$ $I_B = -0.5\text{ mA}$ | [1] | - | -760 | mV | |
| | | $I_C = -100\text{ mA};$ $I_B = -5\text{ mA}$ | [1] | - | -920 | mV | |
| V_{BE} | base-emitter voltage | $V_{CE} = -5\text{ V};$ $I_C = -2\text{ mA}$ | [2] | -600 | -650 | -700 | mV |
| | | $V_{CE} = -5\text{ V};$ $I_C = -10\text{ mA}$ | [2] | - | - | -760 | mV |
| C_c | collector capacitance | $V_{CB} = -10\text{ V};$ $I_E = i_e = 0\text{ A};$ $f = 1\text{ MHz}$ | - | - | 2.2 | pF | |
| C_e | emitter capacitance | $V_{EB} = -0.5\text{ V};$ $I_C = i_c = 0\text{ A};$ $f = 1\text{ MHz}$ | - | 10 | - | pF | |
| f_T | transition frequency | $V_{CE} = -5\text{ V};$ $I_C = -10\text{ mA};$ $f = 100\text{ MHz}$ | 100 | 175 | - | MHz | |
| NF | noise figure | $V_{CE} = -5\text{ V};$ $I_C = -0.2\text{ mA};$ $R_S = 2\text{ k}\Omega;$ $f = 10\text{ Hz to }15.7\text{ kHz}$ | - | 1.6 | - | dB | |
| | | $V_{CE} = -5\text{ V};$ $I_C = -0.2\text{ mA};$ $R_S = 2\text{ k}\Omega;$ $f = 1\text{ kHz};$ $B = 200\text{ Hz}$ | - | 3.1 | - | dB | |

Table 7. Characteristics ...continued $T_{amb} = 25\text{ °C}$ unless otherwise specified.

| Symbol | Parameter | Conditions | Min | Typ | Max | Unit |
|---------------------------|----------------------|---|----------|------|------|------|
| Per transistor TR2 | | | | | | |
| V_{EBS} | emitter-base voltage | $V_{CB} = 0\text{ V};$ $I_E = 250\text{ mA}$ | - | - | 1.5 | V |
| | | $V_{CB} = 0\text{ V};$ $I_E = 10\text{ }\mu\text{A}$ | 400 | - | - | mV |
| Per device | | | | | | |
| I_{C1}/I_{E2} | current matching | $V_{CE1} = -5\text{ V};$ $I_{E2} = 0.5\text{ mA};$ $T_{amb} \leq 25\text{ °C}$ | [3] 1 | 1.1 | 1.2 | |
| | | $V_{CE1} = -5\text{ V};$ $I_{E2} = 0.5\text{ mA};$ $T_{amb} \leq 150\text{ °C}$ | [3] 1.02 | - | 1.22 | |
| | | $V_{CE1} = -3\text{ V};$ $I_{E2} = 0.5\text{ mA};$ $T_{amb} \leq 25\text{ °C}$ | [3] 0.95 | 1.05 | 1.15 | |
| | | $V_{CE1} = -1\text{ V};$ $I_{E2} = 0.5\text{ mA};$ $T_{amb} \leq 25\text{ °C}$ | [3] 0.9 | 1 | 1.1 | |

[1] V_{BEsat} decreases by about 1.7 mV/K with increasing temperature.[2] V_{BE} decreases by about 2 mV/K with increasing temperature.

[3] Device mounted on an FR4 PCB, single-sided copper, tin-plated and standard footprint.

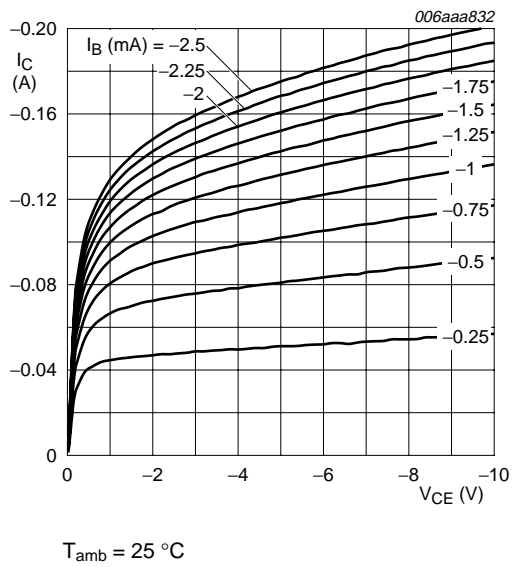

Fig 1. Collector current as a function of collector-emitter voltage; typical values

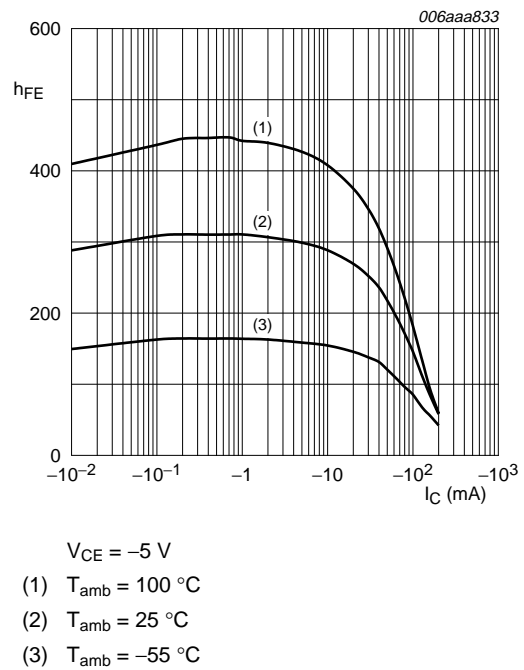

Fig 2. DC current gain as a function of collector current; typical values

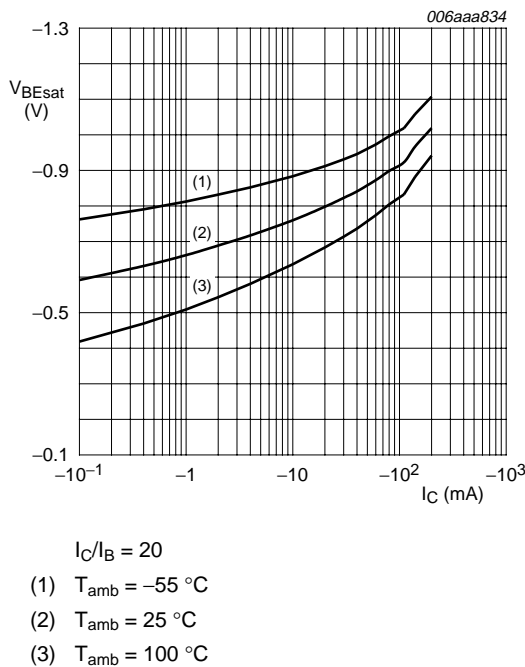

Fig 3. Base-emitter saturation voltage as a function of collector current; typical values

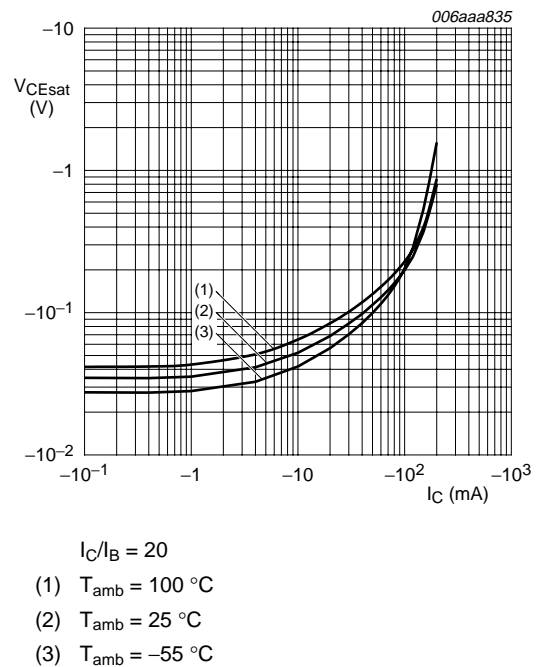
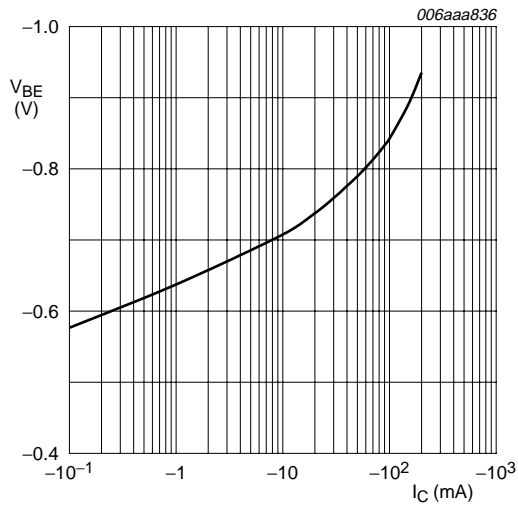
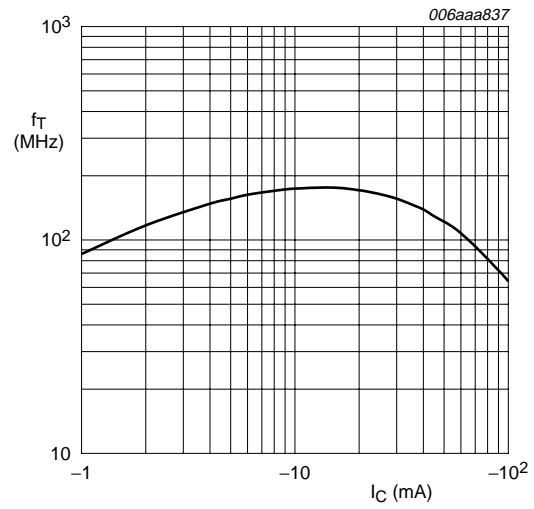

Fig 4. Collector-emitter saturation voltage as a function of collector current; typical values



$V_{CE} = -5$ V; $T_{amb} = 25$ °C

Fig 5. Base-emitter voltage as a function of collector current; typical values



$V_{CE} = -5$ V; $T_{amb} = 25$ °C

Fig 6. Transition frequency as a function of collector current; typical values

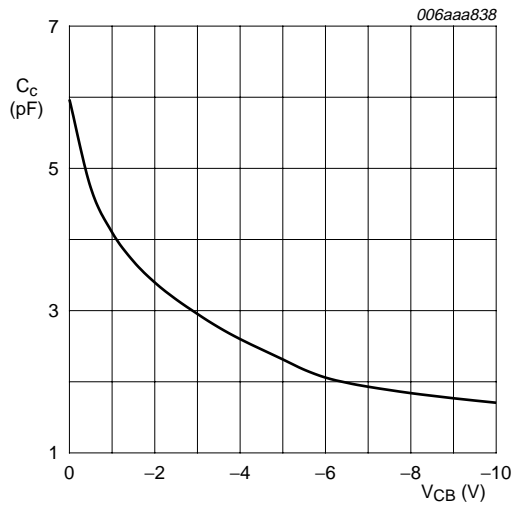

$f = 1$ MHz; $T_{amb} = 25$ °C

Fig 7. Collector capacitance as a function of collector-base voltage; typical values

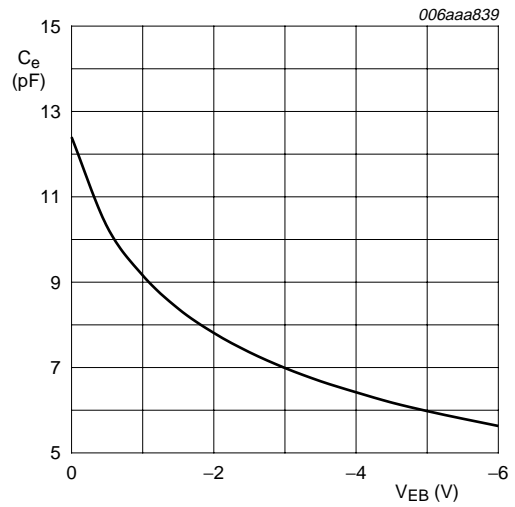

$f = 1$ MHz; $T_{amb} = 25$ °C

Fig 8. Emitter capacitance as a function of emitter-base voltage; typical values

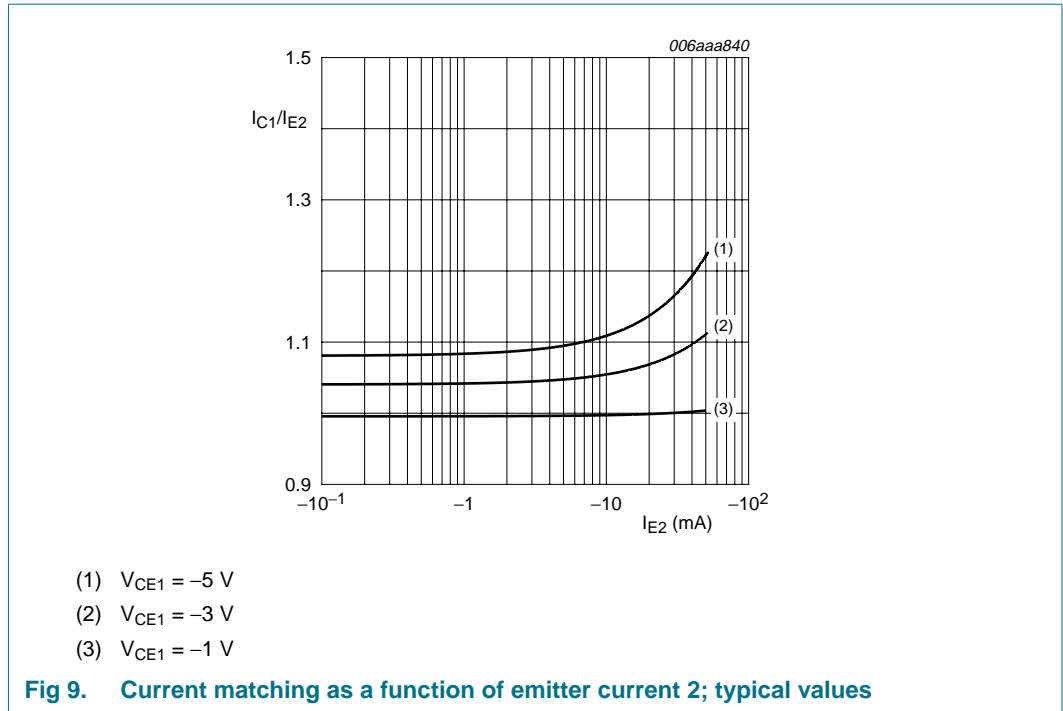

8. Test information

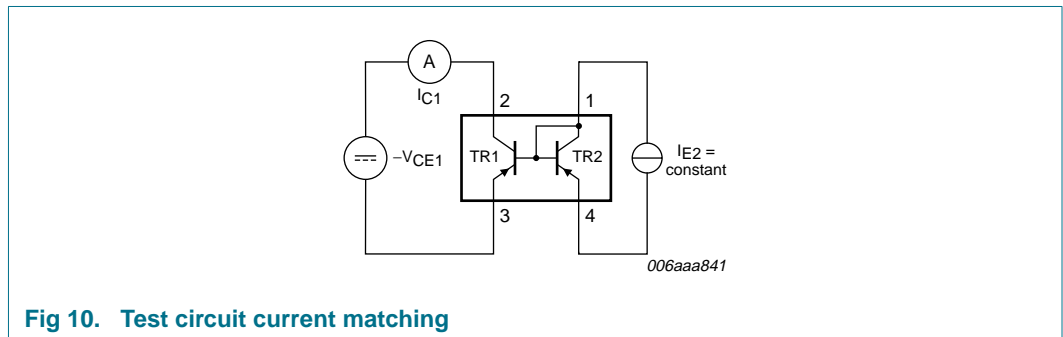

9. Package outline

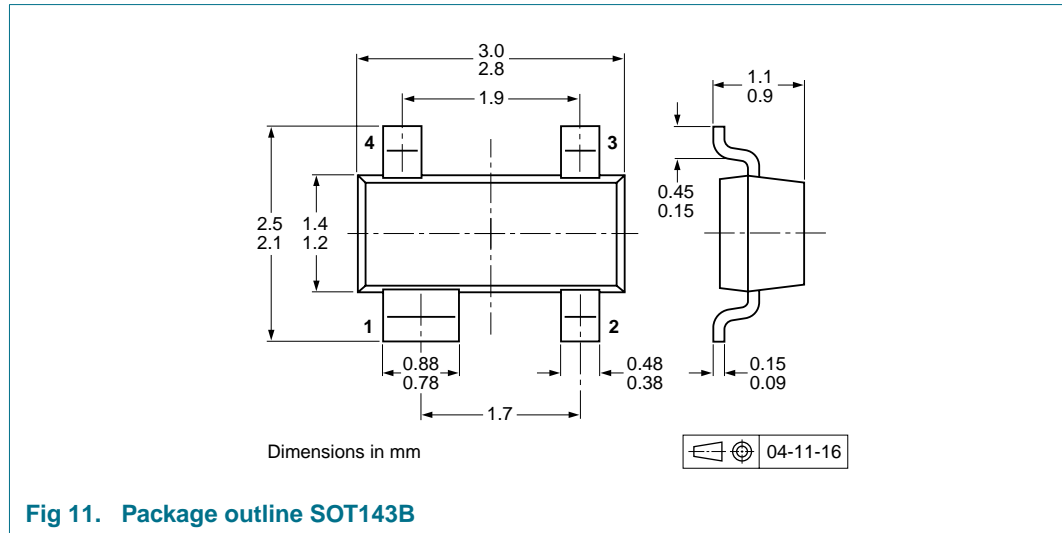

10. Packing information

Please refer to packing information on www.nexperia.com.

11. Soldering

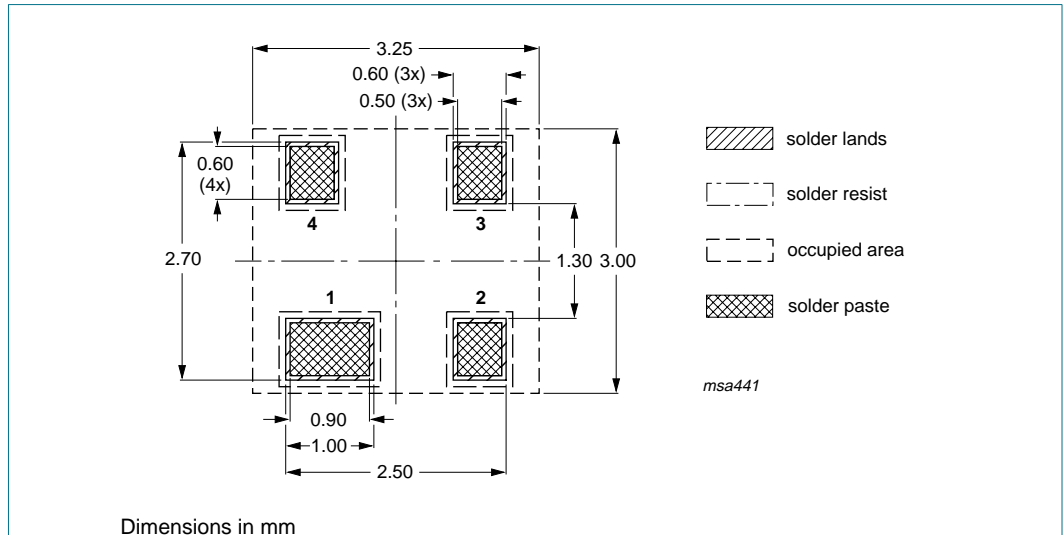

Fig 12. Reflow soldering footprint SOT143B

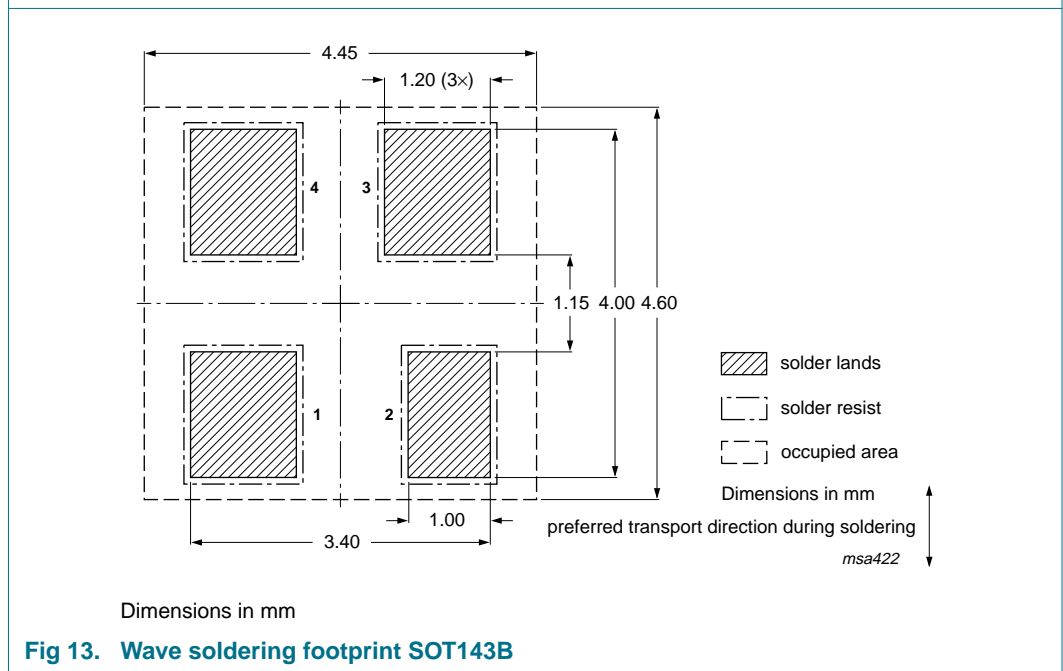

Fig 13. Wave soldering footprint SOT143B

12. Revision history

Table 9. Revision history

| Document ID | Release date | Data sheet status | Change notice | Supersedes |
|----------------|--------------|--|---------------|------------|
| BCM62B_2 | 20090828 | Product data sheet | - | BCM62B_1 |
| Modifications: | | <ul style="list-style-type: none">This data sheet was changed to reflect the new company name NXP Semiconductors, including new legal definitions and disclaimers. No changes were made to the technical content.Figure 13 "Wave soldering footprint SOT143B":updated | | |
| BCM62B_1 | 20060919 | Product data sheet | - | - |

13. Legal information

13.1 Data sheet status

| Document status ^{[1][2]} | Product status ^[3] | Definition |
|-----------------------------------|-------------------------------|---|
| Objective [short] data sheet | Development | This document contains data from the objective specification for product development. |
| Preliminary [short] data sheet | Qualification | This document contains data from the preliminary specification. |
| Product [short] data sheet | Production | This document contains the product specification. |

[1] Please consult the most recently issued document before initiating or completing a design.

[2] The term 'short data sheet' is explained in section "Definitions".

[3] The product status of device(s) described in this document may have changed since this document was published and may differ in case of multiple devices. The latest product status information is available on the Internet at URL <http://www.nexperia.com>.

13.2 Definitions

Draft — The document is a draft version only. The content is still under internal review and subject to formal approval, which may result in modifications or additions. Nexperia does not give any representations or warranties as to the accuracy or completeness of information included herein and shall have no liability for the consequences of use of such information.

Short data sheet — A short data sheet is an extract from a full data sheet with the same product type number(s) and title. A short data sheet is intended for quick reference only and should not be relied upon to contain detailed and full information. For detailed and full information see the relevant full data sheet, which is available on request via the local Nexperia sales office. In case of any inconsistency or conflict with the short data sheet, the full data sheet shall prevail.

13.3 Disclaimers

General — Information in this document is believed to be accurate and reliable. However, Nexperia does not give any representations or warranties, expressed or implied, as to the accuracy or completeness of such information and shall have no liability for the consequences of use of such information.

Right to make changes — Nexperia reserves the right to make changes to information published in this document, including without limitation specifications and product descriptions, at any time and without notice. This document supersedes and replaces all information supplied prior to the publication hereof.

Suitability for use — Nexperia products are not designed, authorized or warranted to be suitable for use in medical, military, aircraft, space or life support equipment, nor in applications where failure or malfunction of an Nexperia product can reasonably be expected to result in personal injury, death or severe property or environmental

damage. Nexperia accepts no liability for inclusion and/or use of Nexperia products in such equipment or applications and therefore such inclusion and/or use is at the customer's own risk.

Applications — Applications that are described herein for any of these products are for illustrative purposes only. Nexperia makes no representation or warranty that such applications will be suitable for the specified use without further testing or modification.

Limiting values — Stress above one or more limiting values (as defined in the Absolute Maximum Ratings System of IEC 60134) may cause permanent damage to the device. Limiting values are stress ratings only and operation of the device at these or any other conditions above those given in the Characteristics sections of this document is not implied. Exposure to limiting values for extended periods may affect device reliability.

Terms and conditions of sale — Nexperia products are sold subject to the general terms and conditions of commercial sale, as published at <http://www.nexperia.com/profile/terms>, including those pertaining to warranty, intellectual property rights infringement and limitation of liability, unless explicitly otherwise agreed to in writing by Nexperia. In case of any inconsistency or conflict between information in this document and such terms and conditions, the latter will prevail.

No offer to sell or license — Nothing in this document may be interpreted or construed as an offer to sell products that is open for acceptance or the grant, conveyance or implication of any license under any copyrights, patents or other industrial or intellectual property rights.

Export control — This document as well as the item(s) described herein may be subject to export control regulations. Export might require a prior authorization from national authorities.

Quick reference data — The Quick reference data is an extract of the product data given in the Limiting values and Characteristics sections of this document, and as such is not complete, exhaustive or legally binding.

13.4 Trademarks

Notice: All referenced brands, product names, service names and trademarks are the property of their respective owners.

14. Contents

| | | |
|-----------|--|-----------|
| 1 | Product profile | 1 |
| 1.1 | General description | 1 |
| 1.2 | Features | 1 |
| 1.3 | Applications | 1 |
| 1.4 | Quick reference data | 1 |
| 2 | Pinning information | 2 |
| 3 | Ordering information | 2 |
| 4 | Marking | 2 |
| 5 | Limiting values | 3 |
| 6 | Thermal characteristics | 3 |
| 7 | Characteristics | 4 |
| 8 | Test information | 8 |
| 9 | Package outline | 9 |
| 10 | Packing information | 9 |
| 11 | Soldering | 10 |
| 12 | Revision history | 11 |
| 13 | Legal information | 12 |
| 13.1 | Data sheet status | 12 |
| 13.2 | Definitions | 12 |
| 13.3 | Disclaimers | 12 |
| 13.4 | Trademarks | 12 |
| 14 | Contents | 13 |

Please be aware that important notices concerning this document and the product(s) described herein, have been included in section 'Legal information'.

© Nexperia B.V. 2009.

All rights reserved.

For more information, please visit: <http://www.nexperia.com>
For sales office addresses, please send an email to:
salesaddresses@nexperia.com

Date of release: 28 August 2009
Document identifier: BCM62B