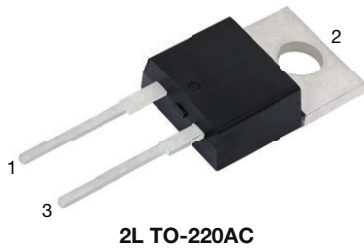
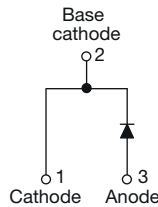

High Voltage, Input Rectifier Diode, 10 A

2L TO-220AC

FEATURES

- Glass passivated pellet chip junction
- Meets JESD 201 class 1A whisker test
- Flexible solution for reliable AC power rectification
- High surge, low V_F rugged blocking diode for DC charging stations
- AEC-Q101 qualified
- Material categorization: for definitions of compliance please see www.vishay.com/doc?99912

RoHS
 COMPLIANT
 HALOGEN
FREE

APPLICATIONS

- On-board and off-board EV/HEV battery chargers
- Input rectification

DESCRIPTION

High voltage rectifiers optimized for very low forward voltage drop with moderate leakage.

These devices are intended for use in main rectification (single or three phase bridge).

PRIMARY CHARACTERISTICS

| | |
|-----------------------|-------------|
| $I_{F(AV)}$ | 10 A |
| V_R | 1200 V |
| V_F at I_F | 1.1 V |
| I_{FSM} | 160 A |
| T_J max. | 150 °C |
| Package | 2L TO-220AC |
| Circuit configuration | Single |

OUTPUT CURRENT IN TYPICAL APPLICATIONS

| APPLICATIONS | SINGLE-PHASE BRIDGE | THREE-PHASE BRIDGE | UNITS |
|------------------------------------------------------------------------------------|---------------------|--------------------|-------|
| Capacitive input filter $T_A = 55$ °C, $T_J = 125$ °C common heatsink of 1 °C/W | 12.0 | 16.0 | A |

MAJOR RATINGS AND CHARACTERISTICS

| SYMBOL | CHARACTERISTICS | VALUES | UNITS |
|-------------|---------------------|-------------|-------|
| $I_{F(AV)}$ | Sinusoidal waveform | 10 | A |
| V_{RRM} | | 1200 | V |
| I_{FSM} | | 160 | A |
| V_F | 10 A, $T_J = 25$ °C | 1.1 | V |
| T_J | | -40 to +150 | °C |

VOLTAGE RATINGS

| PART NUMBER | V_{RRM} , MAXIMUM PEAK REVERSE VOLTAGE V | V_{RSM} , MAXIMUM NON-REPETITIVE PEAK REVERSE VOLTAGE V | I_{RRM} AT 150 °C mA |
|----------------|-----------------------------------------------|--------------------------------------------------------------|------------------------------|
| VS-10ETS12THM3 | 1200 | 1300 | 0.5 |

ABSOLUTE MAXIMUM RATINGS

| PARAMETER | SYMBOL | TEST CONDITIONS | VALUES | UNITS |
|-----------------------------------------------------|---------------|------------------------------------------------|--------|-------------------|
| Maximum average forward current | $I_{F(AV)}$ | $T_C = 105$ °C, 180° conduction half sine wave | 10 | A |
| Maximum peak one cycle non-repetitive surge current | I_{FSM} | 10 ms sine pulse, rated V_{RRM} applied | 135 | |
| | | 10 ms sine pulse, no voltage reapplied | 160 | |
| Maximum I^2t for fusing | I^2t | 10 ms sine pulse, rated V_{RRM} applied | 91 | A ² s |
| | | 10 ms sine pulse, no voltage reapplied | 130 | |
| Maximum $I^2\sqrt{t}$ for fusing | $I^2\sqrt{t}$ | $t = 0.1$ ms to 10 ms, no voltage reapplied | 1300 | A ² √s |

| ELECTRICAL SPECIFICATIONS | | | | | |
|---------------------------------|-------------|----------------------------------------|-------------------------------|--------|------------------|
| PARAMETER | SYMBOL | TEST CONDITIONS | | VALUES | UNITS |
| Maximum forward voltage drop | V_{FM} | 10 A, $T_J = 25\text{ }^\circ\text{C}$ | | 1.1 | V |
| Forward slope resistance | r_t | $T_J = 150\text{ }^\circ\text{C}$ | | 20 | $\text{m}\Omega$ |
| Threshold voltage | $V_{F(TO)}$ | | | 0.82 | V |
| Maximum reverse leakage current | I_{RM} | $T_J = 25\text{ }^\circ\text{C}$ | $V_R = \text{Rated } V_{RRM}$ | 0.05 | mA |
| | | $T_J = 150\text{ }^\circ\text{C}$ | | 0.50 | |

| THERMAL - MECHANICAL SPECIFICATIONS | | | | | |
|-------------------------------------------------------------|----------------|------------------------|--|-------------|---------------------------|
| PARAMETER | SYMBOL | TEST CONDITIONS | | VALUES | UNITS |
| Maximum junction and storage temperature range | T_J, T_{Stg} | | | -40 to +150 | $^\circ\text{C}$ |
| Maximum thermal resistance, junction to case | R_{thJC} | DC operation | | 2.5 | $^\circ\text{C}/\text{W}$ |
| Maximum thermal resistance, junction to ambient (PCB mount) | R_{thJA} | | | 62 | |
| Soldering temperature | T_S | | | 240 | $^\circ\text{C}$ |
| Approximate weight | | | | 2 | g |
| | | | | 0.07 | oz. |
| Marking device | | Case style 2L TO-220AC | | 10ETS12TH | |

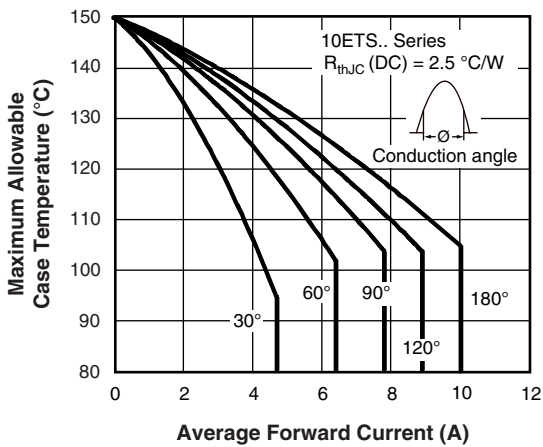

Fig. 1 - Current Rating Characteristics

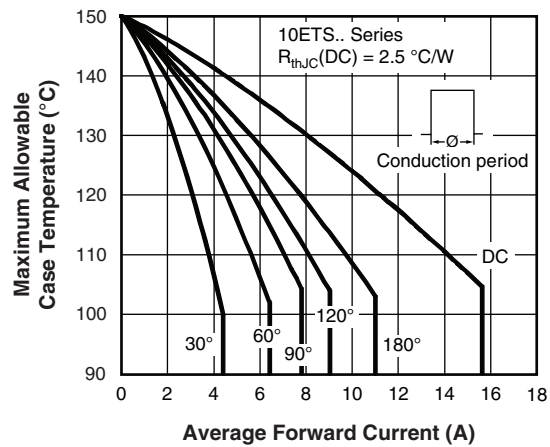

Fig. 2 - Current Rating Characteristics

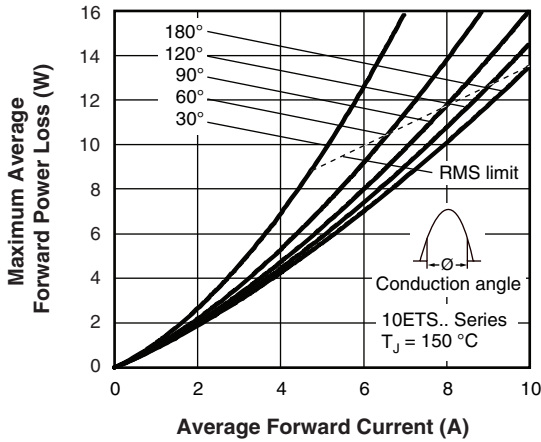

Fig. 3 - Forward Power Loss Characteristics

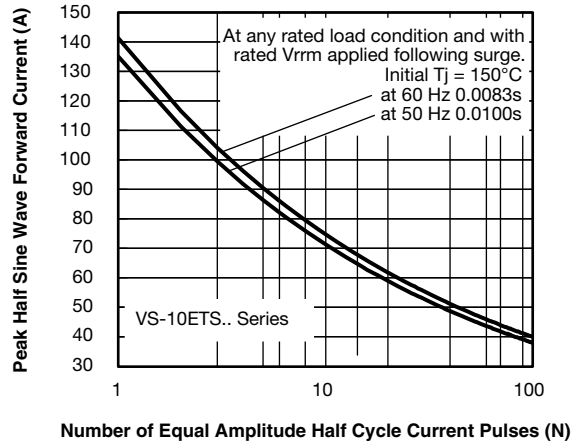

Fig. 5 - Maximum Non-Repetitive Surge Current

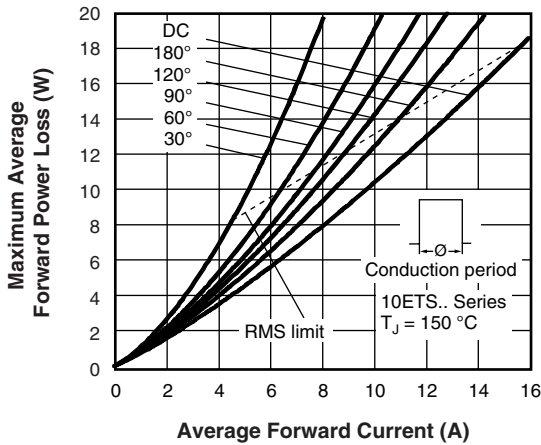

Fig. 4 - Forward Power Loss Characteristics

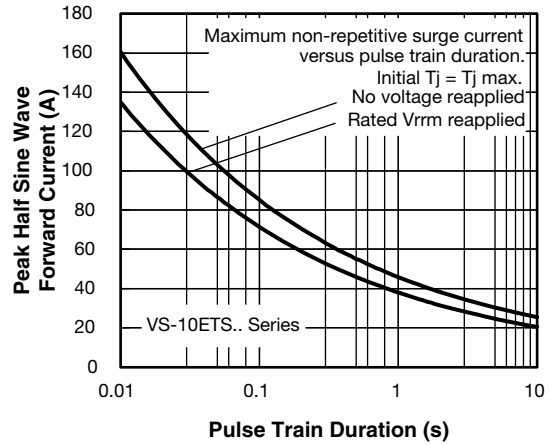

Fig. 6 - Maximum Non-Repetitive Surge Current

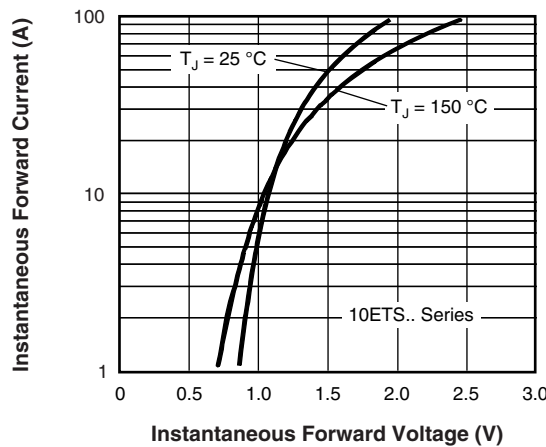

Fig. 7 - Forward Voltage Drop Characteristics

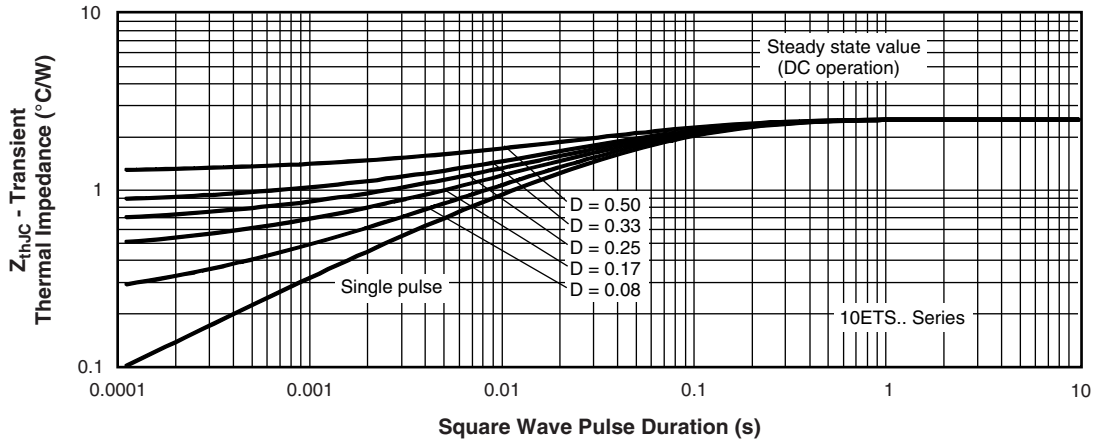

Fig. 8 - Thermal Impedance Z_{thJC} Characteristics

ORDERING INFORMATION TABLE

| | | | | | | | | | |
|-------------|------------|-----------|----------|----------|----------|-----------|----------|----------|-----------|
| Device code | VS- | 10 | E | T | S | 12 | T | H | M3 |
| | ① | ② | ③ | ④ | ⑤ | ⑥ | ⑦ | ⑧ | ⑨ |

- 1** - Vishay Semiconductors product
- 2** - Current rating (10 = 10 A)
- 3** - Circuit configuration:
E = 2L TO-220AC
- 4** - Package:
T = TO-220
- 5** - Type of silicon:
S = standard recovery rectifier
- 6** - Voltage code x 100 = V_{RRM} ——— **12 = 1200 V**
- 7** -
 - None = TO-220AB
 - T = true pin TO-220
- 8** - H = AEC-Q101 qualified
- 9** - Environmental digit:
M3 = halogen-free, RoHS-compliant, and terminations lead (Pb)-free

| ORDERING INFORMATION (Example) | | | |
|---------------------------------------|------------------|------------------------|--------------------------|
| PREFERRED P/N | QUANTITY PER T/R | MINIMUM ORDER QUANTITY | PACKAGING DESCRIPTION |
| VS-10ETS12THM3 | 50 | 1000 | Antistatic plastic tubes |

| LINKS TO RELATED DOCUMENTS | |
|-----------------------------------|------------------------------------------------------------------------|
| Dimensions | www.vishay.com/doc?96069 |
| Part marking information | www.vishay.com/doc?95391 |

2L TO-220AC

DIMENSIONS in millimeters and inches

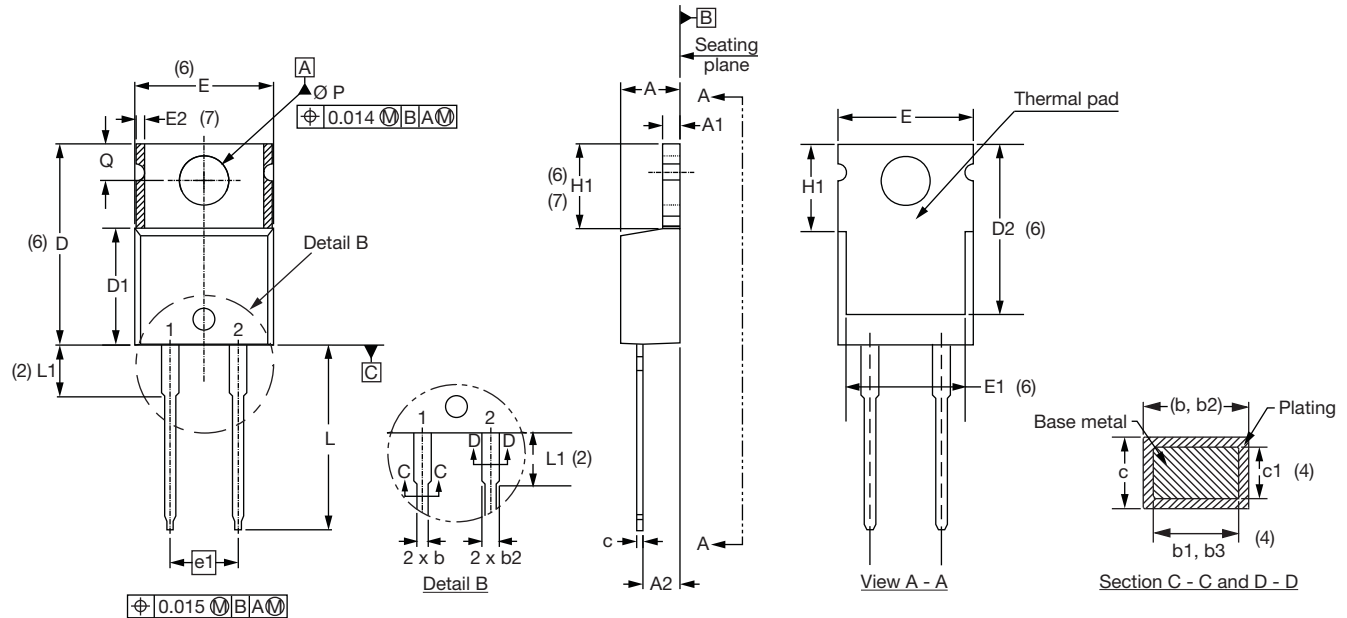

| SYMBOL | MILLIMETERS | | INCHES | | NOTES |
|--------|-------------|-------|--------|-------|-------|
| | MIN. | MAX. | MIN. | MAX. | |
| A | 4.25 | 4.65 | 0.167 | 0.183 | |
| A1 | 1.14 | 1.40 | 0.045 | 0.055 | |
| A2 | 2.56 | 2.92 | 0.101 | 0.115 | |
| b | 0.69 | 1.01 | 0.027 | 0.040 | |
| b1 | 0.38 | 0.97 | 0.015 | 0.038 | 4 |
| b2 | 1.20 | 1.73 | 0.047 | 0.068 | |
| b3 | 1.14 | 1.73 | 0.045 | 0.068 | 4 |
| c | 0.36 | 0.61 | 0.014 | 0.024 | |
| c1 | 0.36 | 0.56 | 0.014 | 0.022 | 4 |
| D | 14.85 | 15.25 | 0.585 | 0.600 | 3 |
| D1 | 8.38 | 9.02 | 0.330 | 0.355 | |
| D2 | 11.68 | 12.88 | 0.460 | 0.507 | 6 |
| E | 10.11 | 10.51 | 0.398 | 0.414 | 3, 6 |

| SYMBOL | MILLIMETERS | | INCHES | | NOTES |
|----------|-------------|-------|--------|-------|-------|
| | MIN. | MAX. | MIN. | MAX. | |
| E1 | 6.86 | 8.89 | 0.270 | 0.350 | 6 |
| E2 | - | 0.76 | - | 0.030 | 7 |
| e1 | 4.88 | 5.28 | 0.192 | 0.208 | |
| H1 | 5.84 | 6.86 | 0.230 | 0.270 | 6, 7 |
| L | 13.52 | 14.02 | 0.532 | 0.552 | |
| L1 | 3.32 | 3.82 | 0.131 | 0.150 | 2 |
| Φ P | 3.54 | 3.73 | 0.139 | 0.147 | |
| Q | 2.60 | 3.00 | 0.102 | 0.118 | |

Notes

- (1) Dimensioning and tolerancing as per ASME Y14.5M-1994
- (2) Lead dimension and finish uncontrolled in L1
- (3) Dimension D, D1 and E do not include mold flash. Mold flash shall not exceed 0.127 mm (0.005") per side. These dimensions are measured at the outermost extremes of the plastic body
- (4) Dimension b1, b3 and c1 apply to base metal only
- (5) Controlling dimension: inches
- (6) Thermal pad contour optional within dimensions E, H1, D2 and E1
- (7) Dimension E2 x H1 define a zone where stamping and singulation irregularities are allowed
- (8) Outline conforms to JEDEC® TO-220, except D2, where JEDEC® minimum is 0.480"



Disclaimer

ALL PRODUCT, PRODUCT SPECIFICATIONS AND DATA ARE SUBJECT TO CHANGE WITHOUT NOTICE TO IMPROVE RELIABILITY, FUNCTION OR DESIGN OR OTHERWISE.

Vishay Intertechnology, Inc., its affiliates, agents, and employees, and all persons acting on its or their behalf (collectively, "Vishay"), disclaim any and all liability for any errors, inaccuracies or incompleteness contained in any datasheet or in any other disclosure relating to any product.

Vishay makes no warranty, representation or guarantee regarding the suitability of the products for any particular purpose or the continuing production of any product. To the maximum extent permitted by applicable law, Vishay disclaims (i) any and all liability arising out of the application or use of any product, (ii) any and all liability, including without limitation special, consequential or incidental damages, and (iii) any and all implied warranties, including warranties of fitness for particular purpose, non-infringement and merchantability.

Statements regarding the suitability of products for certain types of applications are based on Vishay's knowledge of typical requirements that are often placed on Vishay products in generic applications. Such statements are not binding statements about the suitability of products for a particular application. It is the customer's responsibility to validate that a particular product with the properties described in the product specification is suitable for use in a particular application. Parameters provided in datasheets and / or specifications may vary in different applications and performance may vary over time. All operating parameters, including typical parameters, must be validated for each customer application by the customer's technical experts. Product specifications do not expand or otherwise modify Vishay's terms and conditions of purchase, including but not limited to the warranty expressed therein.

Hyperlinks included in this datasheet may direct users to third-party websites. These links are provided as a convenience and for informational purposes only. Inclusion of these hyperlinks does not constitute an endorsement or an approval by Vishay of any of the products, services or opinions of the corporation, organization or individual associated with the third-party website. Vishay disclaims any and all liability and bears no responsibility for the accuracy, legality or content of the third-party website or for that of subsequent links.

Except as expressly indicated in writing, Vishay products are not designed for use in medical, life-saving, or life-sustaining applications or for any other application in which the failure of the Vishay product could result in personal injury or death. Customers using or selling Vishay products not expressly indicated for use in such applications do so at their own risk. Please contact authorized Vishay personnel to obtain written terms and conditions regarding products designed for such applications.

No license, express or implied, by estoppel or otherwise, to any intellectual property rights is granted by this document or by any conduct of Vishay. Product names and markings noted herein may be trademarks of their respective owners.