

DESCRIPTION: M5 FEMALE - RIGHT ANGLE - PANEL MOUNT - 2 POSITION

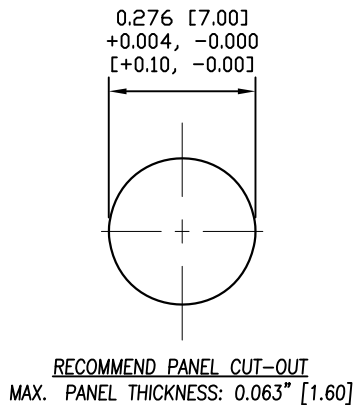
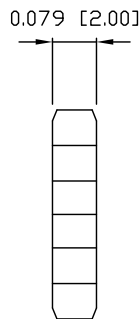
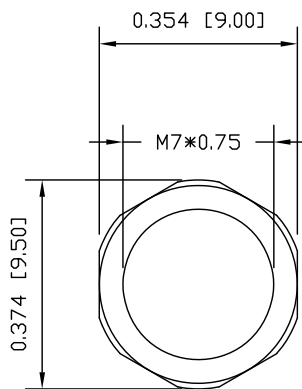
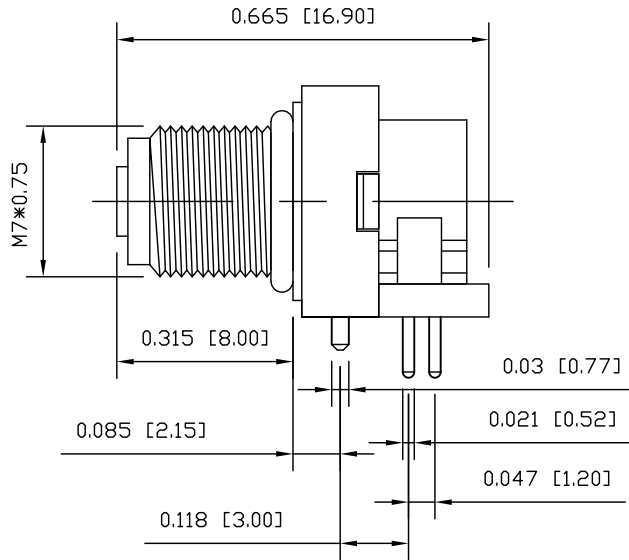
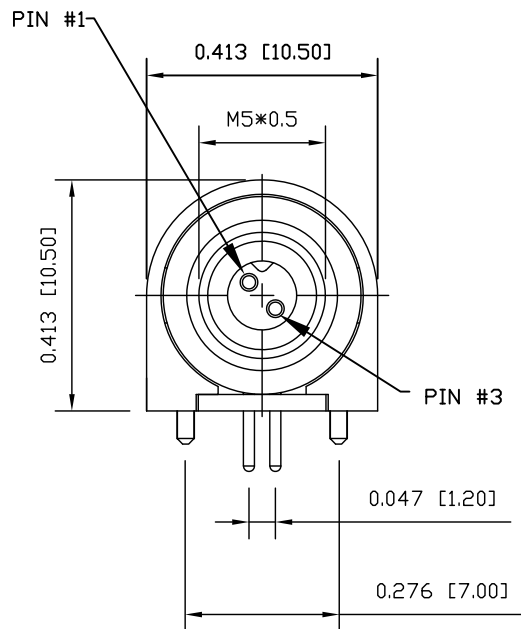

NUT

NOTE:

MATERIAL

HOUSING:	PBT UL94V-0, BLACK
CONTACT:	BRASS
NUT:	BRASS
O-RING:	NBR, BLACK
BACK HOUSING:	PBT UL94V-0, BLACK
DOWN HOUSING:	PBT UL94V-0, BLACK

FINISH

CONTACT:	GOLD PLATED
	OVER 50µ" NICKEL
NUT:	NICKEL PLATED

ELECTRICAL

RATED CURRENT:	1A
RATED VOLTAGE:	60V
INSULATION RESISTANCE:	100 MΩhms MIN.
CONTACT RESISTANCE:	10 mΩhms MAX.
WATER PROOF:	IP67
ENVIRONMENT	
OPERATION TEMPERATURE:	-40°C TO +85°C

853-002-213R00Y

1 = GOLD FLASH  
4 = 10µ" GOLD

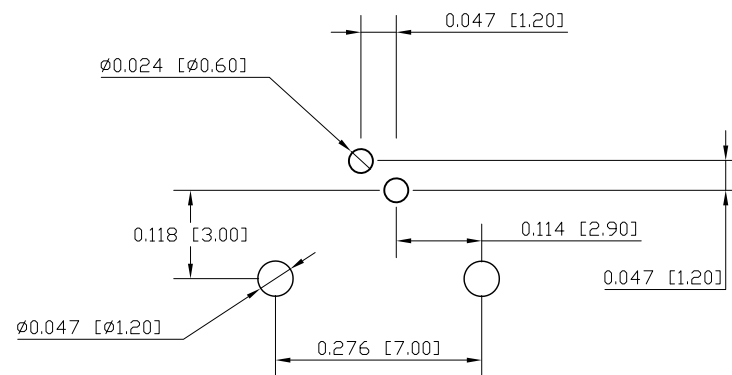

RECOMMENDED PCB LAYOUT

RoHS COMPLIANT

UNITS = INCHES [MM]

DO NOT SCALE FROM DRAWING



THESE DRAWINGS AND SPECIFICATIONS ARE THE PROPERTY OF NorComp AND SHALL NOT BE REPRODUCED, COPIED OR USED AS THE BASIS FOR THE MANUFACTURE OR SALE OF APPARATUS WITHOUT WRITTEN PERMISSION.

DRAWN:

M. SIGMON

DATE:

03-03-16

NorComp

SCALE:

NTS

SHEET

1

OF

1

REV

8

DWG NO.

853-002-213R00Y