

0RQB-30Y05L

Isolated DC-DC Converter

The 0RQB-30Y05L is an isolated DC/DC converter providing 30 W of output power from a wide input range (24 V, 48 V, 72 V, 96 V, 110 V typical). Standard features include remote on/off, input under-voltage protection, output over-voltage protection, over current and short circuit protection.

This converter can also provide a 5 V/5 mA auxiliary supply. When a large hold-up capacitor is added, the converter can still work up to 12 ms when the input supply is interrupted. Conformal coated PCB is used for environmental ruggedness.



Key Features & Benefits

- 24 / 48 / 72 / 96 / 110 VDC Input
- 5 VDC / 6 A Output
- Reinforced Isolation
- Input Under-Voltage Protection
- High Efficiency
- Output Over-Voltage Protection
- Hold-up Function
- Over Current and Short Circuit Protection
- Remote ON/OFF
- Over Temperature Protection
- Conformal Coated
- 5V Auxiliary Supply at Primary Side
- Wide Input Range (24 V, 48 V, 72 V, 96 V, 110 V typical)
- Approved to EN 62368-1
- Class II, Category 2, Isolated DC/DC Converter (refer to IPC-9592B)

Applications

- Industrial
- Railway

1. MODEL SELECTION

MODEL NUMBER ACTIVE LOW	OUTPUT VOLTAGE	INPUT VOLTAGE	MAX. OUTPUT CURRENT	MAX. OUTPUT POWER	TYPICAL EFFICIENCY
ORQB-30Y05LG	5 VDC	24 / 48 / 72 / 96 / 110 VDC	6 A	30 W	82%

PART NUMBER EXPLANATION

0	R	QB	-	30	Y	05	L	G
Mounting Type	RoHS Status	Series Name		Output Power	Input Range	Output Voltage	Active Logic & HSK Feature	Package Type
Through Hole Mount	RoHS	DOSA Quarter Brick		30 W	24 / 48 / 72 / 96 / 110 V	5 V	Active Low, with Baseplate	Tray Package

2. ABSOLUTE MAXIMUM RATINGS

PARAMETER	DESCRIPTION	MIN	TYP	MAX	UNITS
Continuous non-operating Input Voltage		0.5	-	160	V
Remote On/Off		-0.3	-	15	V
Thermal Resistance	Baseplate to heatsink, flat greased surface	-	0.24	-	°C/W
	Baseplate to ambient	-	4	-	
Operating Temperature	Temp. measured at the center of the baseplate, full load	-40	-	105	°C
Storage Temperature		-55	-	125	°C
Altitude		-	-	2000	m

NOTE: Ratings used beyond the maximum ratings may cause a reliability degradation of the converter or may permanently damage the device.

3. INPUT SPECIFICATIONS

PARAMETER	DESCRIPTION	MIN	TYP	MAX	UNIT
Operating Input Voltage Range 1	Fully functioning for long term operation.	16.8	24	137.5	V
			48		
			72		
			96		
			110		
Operating Input Voltage Range 2	Fully functioning for 0.1 s operation. Full function is not guaranteed but undamaged for 1 s operation.	12.9	-	16.8	V
Input Current		-	-	3.0	A
Input Voltage Rising Slope		-	-	2	V/ms
Input Current (no load)		-	100	150	mA
Remote Off Input Current		-	-	40	mA
Input Reflected Ripple Current (pk-pk)	With simulated source impedance of 10 μ H, 5 Hz to 20 MHz. Use two 100 μ F/250 V electrolytic capacitors with ESR = 0.5R max, at 200 kHz @ 25°C.	-	-	300	mA
Input Reflected Ripple Current (rms)		-	-	100	mA
Under-voltage Turn on Threshold	Lockout turn on	14.5	15.2	16	V
Under-voltage Turn off Threshold	Lockout turn off, non-latching	11.7	12.2	12.7	V
Recommended input fast-acting fuse on system board	CAUTION: This converter is not internally fused. An input line fuse must be used in application.	-	6	-	V

4. OUTPUT SPECIFICATIONS

PARAMETER	DESCRIPTION	MIN	TYP	MAX	UNIT
Output Voltage Set Point		4.9	5	5.1	V
Line Regulation		-	-	10	mV
Load Regulation		-	-	20	mV
Regulation Over Temperature		-	-	±100	mV
Output Current Range		0	-	6	A
Output Ripple and Noise (pk-pk)	With a 100 μ F ceramic and a 100 μ F electrolytic capacitors at output.	-	50	80	mV
Output Ripple and Noise (rms)		-	10	15	mV
Output DC Current Limit	Enter a hiccup mode, non-latching.	7	-	10	A
Turn on Time	Enable from Vin	-	-	1500	ms
	Enable from ON/OFF	-	-	200	ms
Rise Time		-	25	50	ms
Overshoot at Turn on		-	0	3	%
Undershoot at Turn off		-	0	3	%
Output Capacitance	Typically 50% ceramic and 50% electrolytic capacitors.	200	-	1000	μ F
5V Auxiliary Supply Source Current		-	-	5	mA
Transient Response					
ΔV 50% ~ 75% of Max Load		-	200	250	mV
Settling Time	di/dt = 0.1 A/ μ s, with a 100 μ F ceramic and a 100 μ F electrolytic capacitors near the brick output.	-	0.5	0.75	ms
ΔV 75% ~ 50% of Max Load		-	200	250	mV
Settling Time		-	0.5	0.75	ms

NOTE: All specifications are typical at nominal input, full load at 25°C unless noted.

5. GENERAL SPECIFICATIONS

PARAMETER	DESCRIPTION	MIN	TYP	MAX	UNIT
Efficiency	Vin = 24 V, Iout = 6 A	81	82	-	%
	Vin = 48 V, Iout = 6 A	82	83	-	
	Vin = 72 V, Iout = 6 A	82	83	-	
	Vin = 96 V, Iout = 6 A	82	83	-	
	Vin = 110 V, Iout = 6 A	83	84	-	
Switching Frequency	1st stage	-	150	-	kHz
	2nd stage	-	250	-	
FIT*	Calculated Per IEC 62380 TR 1 (UTEC 80-810)	-	176.66	-	
MTBF*	(Vin=24 V, Vo=5V, Io=6A, Tac = 50°C, Ta=35°C)	-	5.66	-	Mhours
Dimensions (L x W xH)		2.30 x1.45 x 0.59			inch
		58.42 x 36.83 x15.0			mm
Weight		-	62	-	g
Over Temperature Protection		-	125	-	°C
Over Voltage Protection (Static)		-	6	-	V
Isolation Characteristics					
Isolation Capacitance		-	-	2200	pF
Isolation Resistance		10M	-	-	ohm
Input to Output		-	-	2250	V
Input to Heatsink		-	-	2250	V
Output to Heatsink		-	-	2250	V

NOTE: All specifications are typical at 25 °C unless otherwise stated.

6. EFFICIENCY DATA

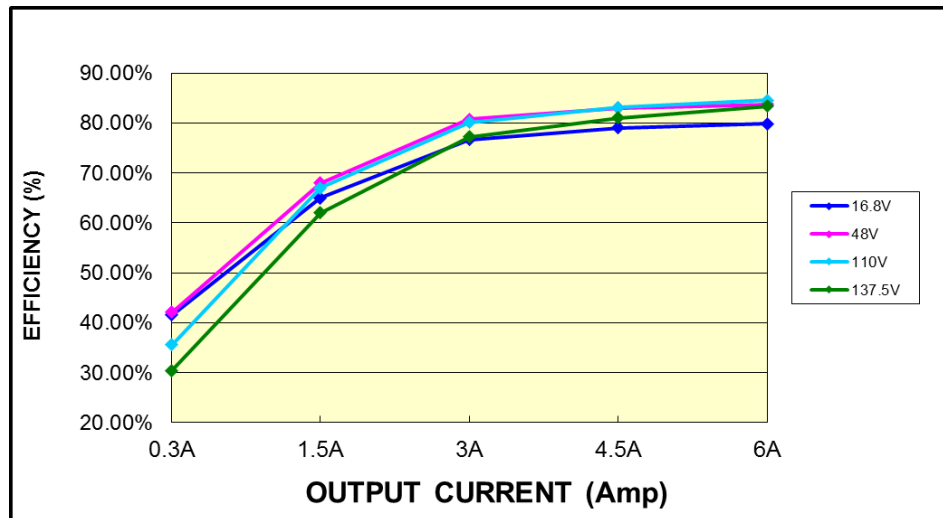

Figure 1. Efficiency

7. REMOVE ON/OFF

PARAMETER	DESCRIPTION	MIN	TYP	MAX	UNIT
Signal Low (Unit On)	Active Low Remote On/Off pin is open, the module is off.	-0.3	-	0.8	V
Signal High (Unit Off)		2.4	-	15	
Current Sink		0	-	1	mA

Recommended Remote On/Off Circuit for Active Low

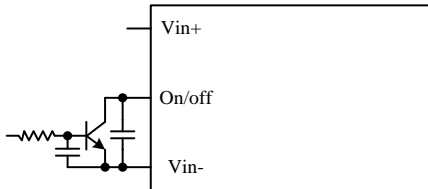

Figure 2. Control with open collector/drain circuit

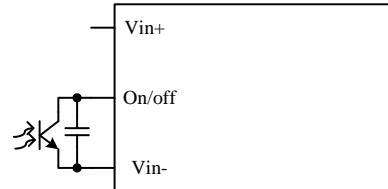

Figure 3. Control with photocoupler circuit

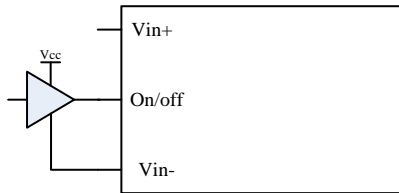

Figure 4. Control with logic circuit

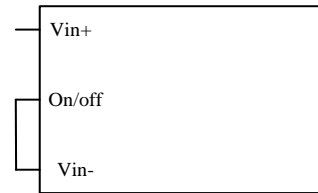

Figure 5. Permanently on

8. RIPPLE AND NOISE WAVEFORM

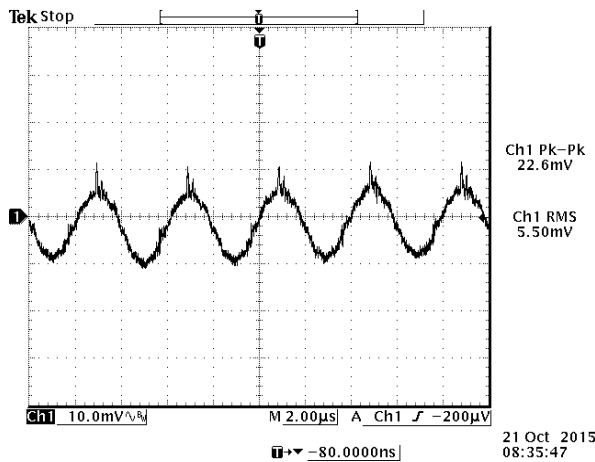

Figure 6.

NOTE: Ripple & noise at full load, 48 V input, with a 1 µF ceramic capacitor and a 10 µF tantalum capacitor at the output, and Ta = 25°C.

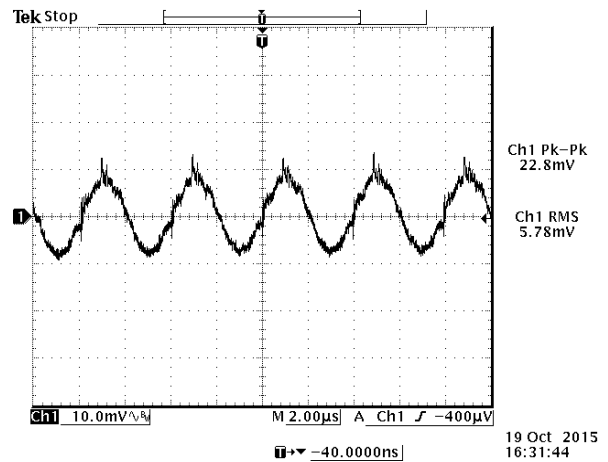

Figure 7.

NOTE: Ripple and noise, 110 VDC input, 5 VDC / 6 A output and Ta=25 °C, with 100 µF ceramic capacitor and 100 µF AL cap at output.



Asia-Pacific +86 755 298 85888 Europe, Middle East +353 61 225 977 North America +1 408 785 5200

9. INPUT NOISE

Input Reflected Ripple Current

Testing setup

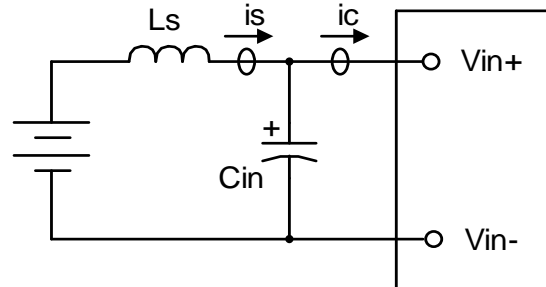

Figure 8.

Notes and values in testing:

is: Input Reflected Ripple Current

ic: Input Terminal Ripple Current

Ls: Simulated Source Impedance (10 μ H)

Cin: Electrolytic capacitor, should be as closed as possible to the power module to dampen ic ripple current and enhance stability. Recommendation: 2* 100 μ F, ESR<0.5R @ 100 kHz, 20°C

Below measured waveforms are based on above simulated and recommended inductance and capacitance.

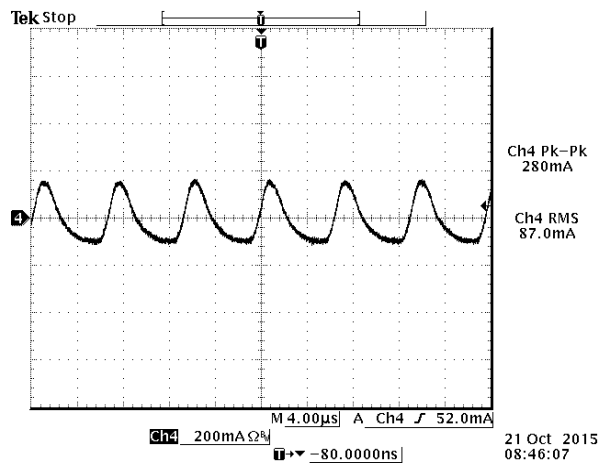

Figure 9. i_s (input reflected ripple current), AC component

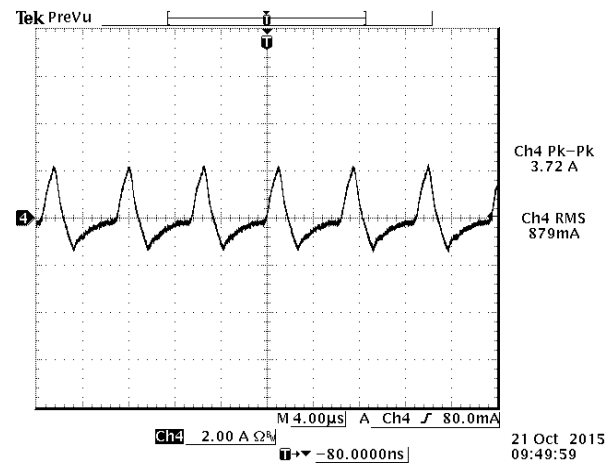

Figure 10. i_c (input reflected ripple current), AC component

NOTE: 48 VDC input, 5 VDC / 6 A output and $T_a = 25^\circ\text{C}$, with 100 μ F ceramic capacitor and 100 μ F AL. cap at output.

10. TRANSIENT RESPONSE

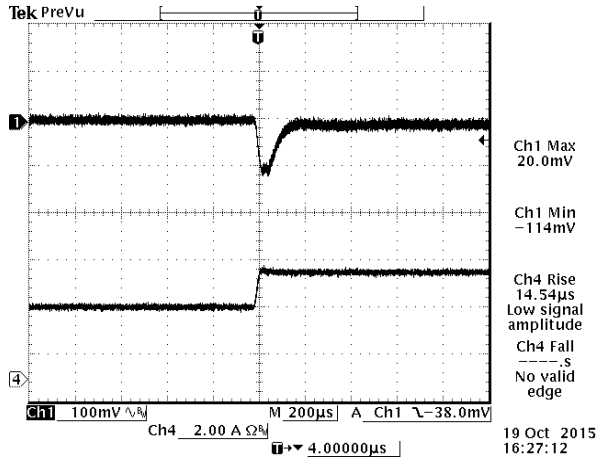

Figure 11. 50%-75% Load Transients at $V_{in} = 48\text{ V}$ @ $T_a = 25^\circ\text{C}$

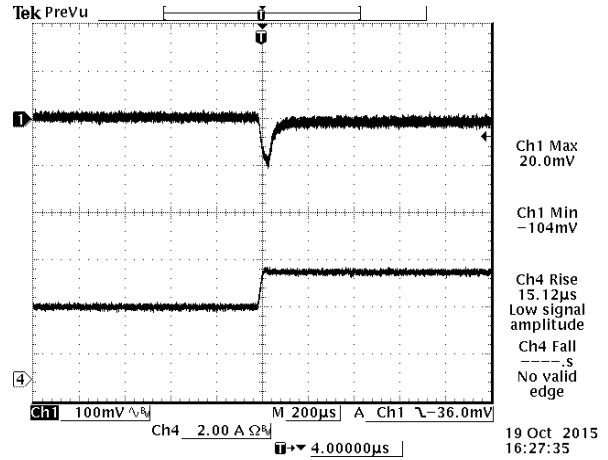

Figure 12. 50%-75% Load Transients at $V_{in} = 110\text{ V}$ @ $T_a = 25^\circ\text{C}$

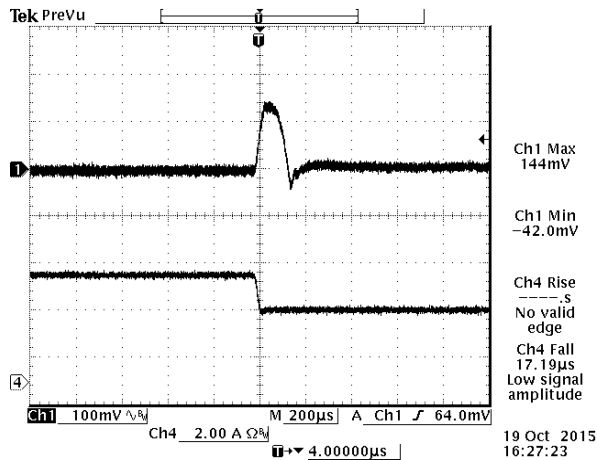

Figure 13. 75%-50% Load Transients at $V_{in} = 48\text{ V}$ @ $T_a = 25^\circ\text{C}$

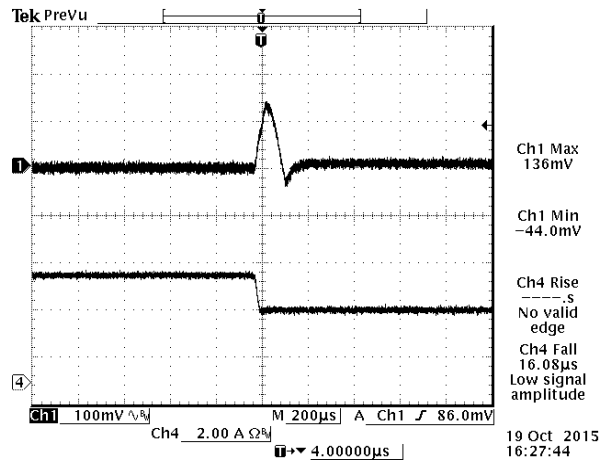

Figure 14. 75%-50% Load Transients at $V_{in} = 110\text{ V}$ @ $T_a = 25^\circ\text{C}$

11. STARTUP & SHUTDOWN

Turn on rise time:

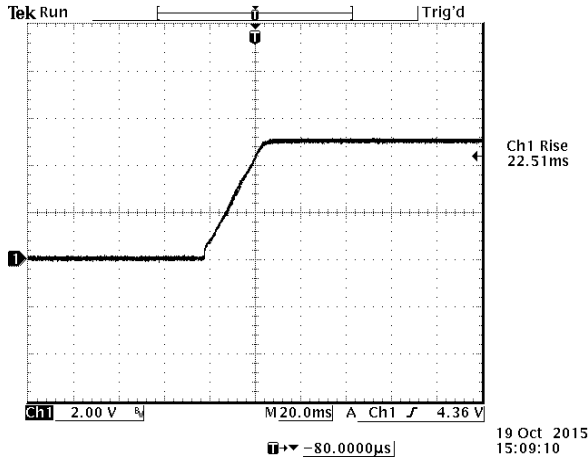

Figure 15. $V_{in} = 48\text{ V}$, $I_o = 6\text{ A}$, $V_o = 5\text{ V}$

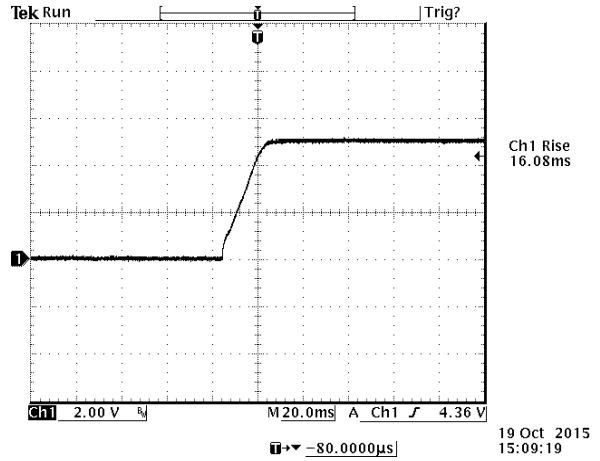

Figure 16. $V_{in} = 110\text{ V}$, $I_o = 6\text{ A}$, $V_o = 5\text{ V}$

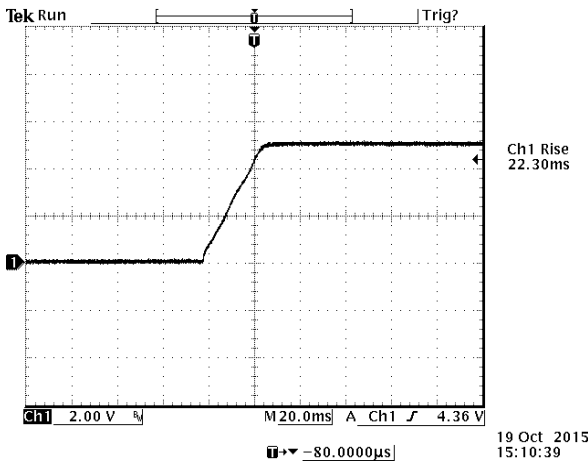

Figure 17. $V_{in} = 48\text{ V}$, $I_o = 6\text{ A}$, $V_o = 5\text{ V}$, with $C_{ext} = 1000\ \mu\text{F}$

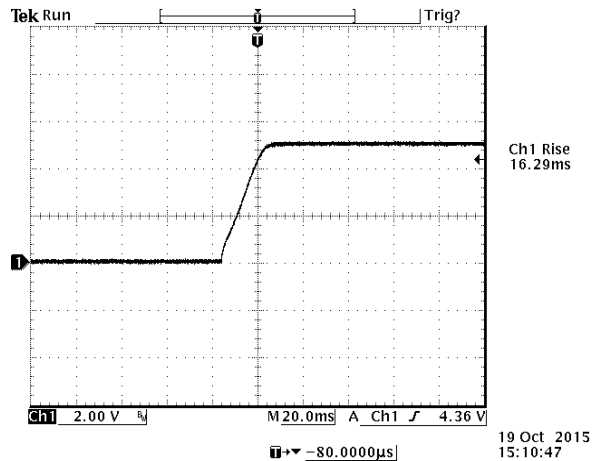

Figure 18. $V_{in} = 48\text{ V}$, $I_o = 6\text{ A}$, $V_o = 5\text{ V}$, with $C_{ext} = 1000\ \mu\text{F}$

Turn on delay time:

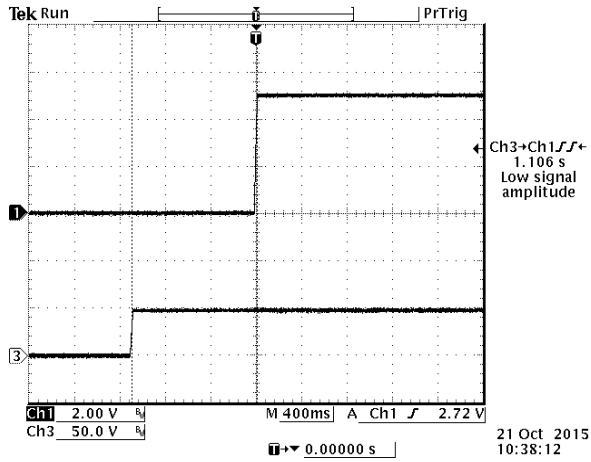

Figure 19. Startup from Vin
Ch1: Vo
Ch3: Vin
Vin = 48 V, Io = 6 A, Vo = 5 V

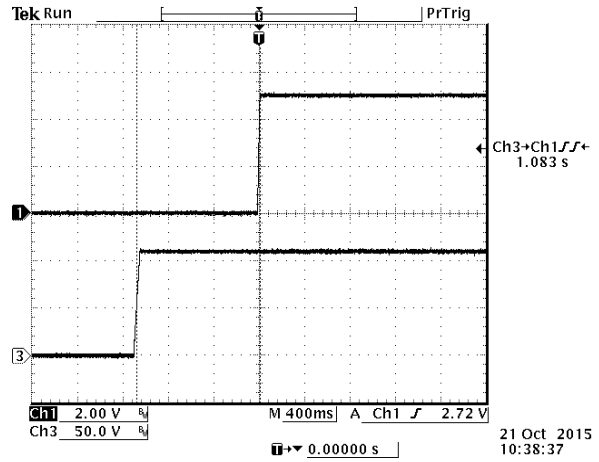

Figure 20. Startup from Vin
Ch1: Vo
Ch3: Vin
Vin = 110 V, Io = 6 A, Vo = 5 V

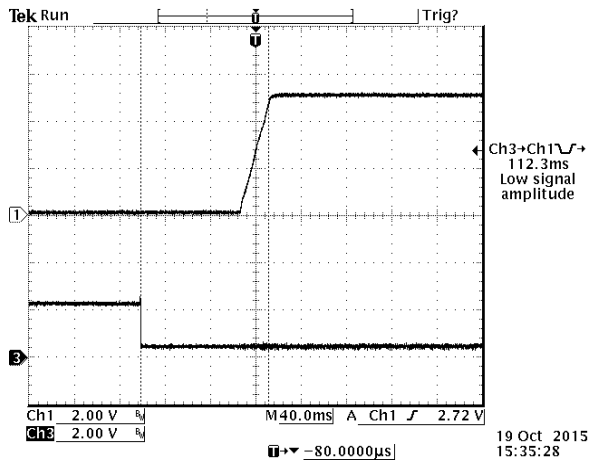

Figure 21. Startup from on/off
Ch1: Vo
Ch3: on/off
Vin = 48 V, Io = 6 A, Vo = 5 V

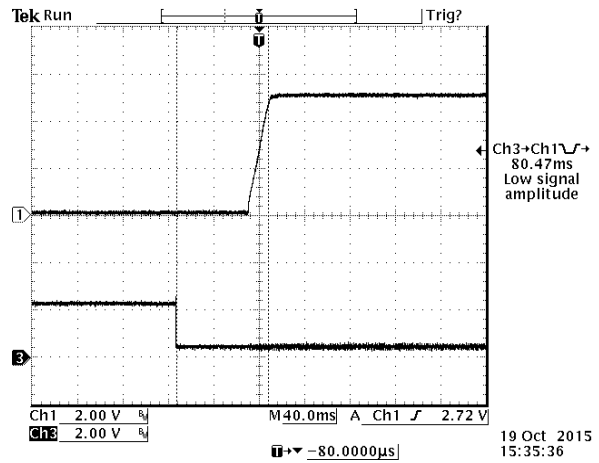

Figure 22. Startup from on/off
Ch1: Vo
Ch3: on/off
Vin = 110 V, Io = 6 A, Vo = 5 V

Shutdown

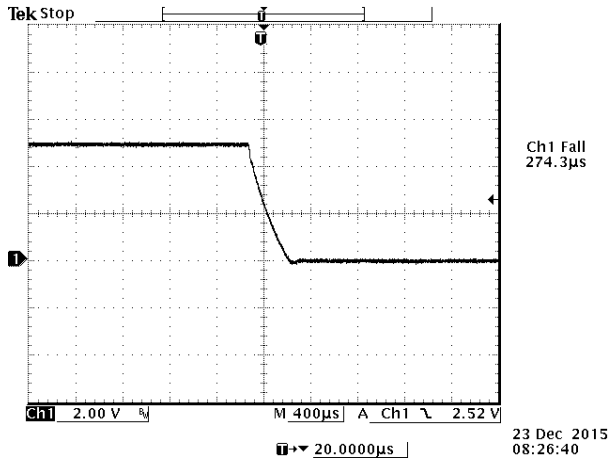

Figure 23. $V_{in} = 48\text{ V}$, $I_o = 6\text{ A}$, $V_o = 5\text{ V}$

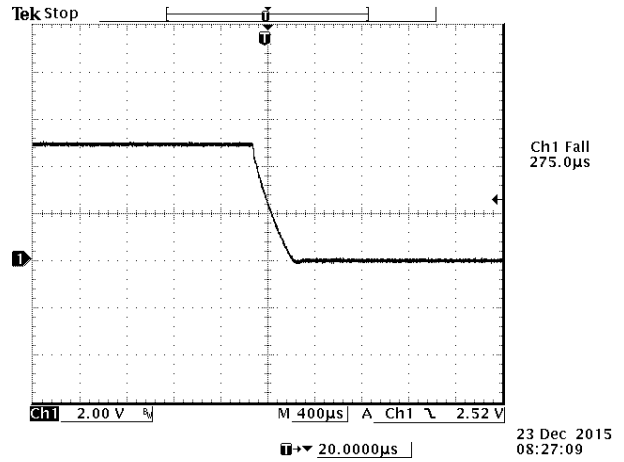

Figure 24. $V_{in} = 48\text{ V}$, $I_o = 6\text{ A}$, $V_o = 5\text{ V}$

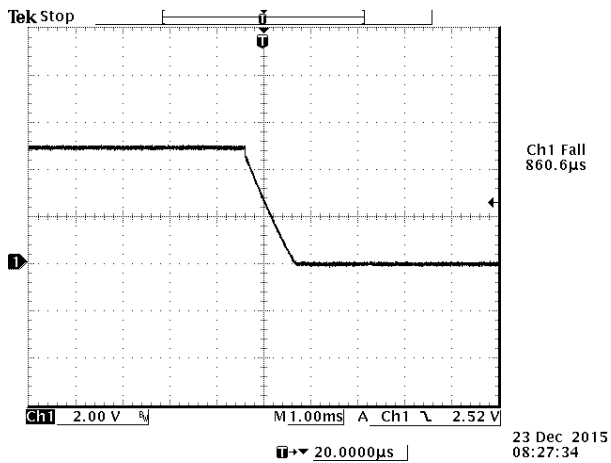

Figure 25. $V_{in} = 48\text{ V}$, $I_o = 6\text{ A}$, $V_o = 5\text{ V}$, with $C_{ext} = 1000\text{ }\mu\text{F}$

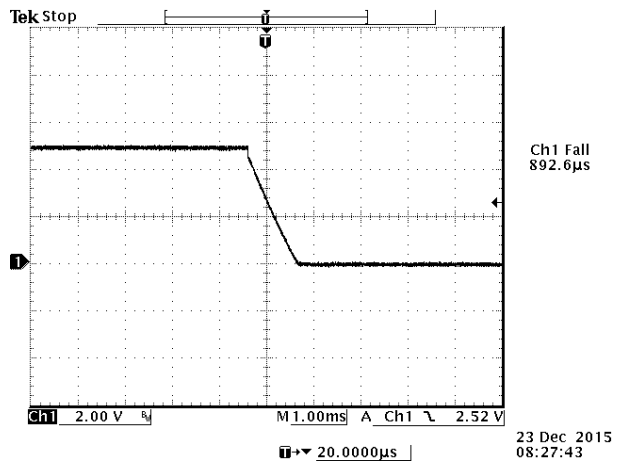

Figure 26. $V_{in} = 48\text{ V}$, $I_o = 6\text{ A}$, $V_o = 5\text{ V}$, with $C_{ext} = 1000\text{ }\mu\text{F}$

12. HOLD UP CIRCUIT

PARAMETER	DESCRIPTION	SYMBOL	MIN	TYP	MAX	UNITS
Hold up Capacitor	Working voltage rating should be 200 V. Caution: This capacitor is necessary for both normal and hold up operation.	C_HOLD	220	-	330	μF
Hold up Voltage	Normal operation.	V_HOLD	45	85	154	V
Hold up Time	16.8 - 137.5 V input and all lout range.	T_HOLD	12	-	-	ms

Recommended External Hold up Circuit

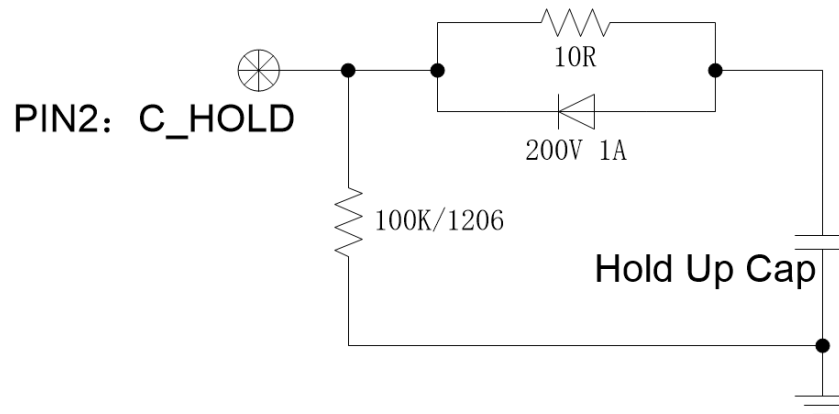

Figure 27.

NOTE: the power of the current-limiting resistance is determined by the rise slope of the input voltage.

13. INPUT UNDER-VOLTAGE LOCKOUT

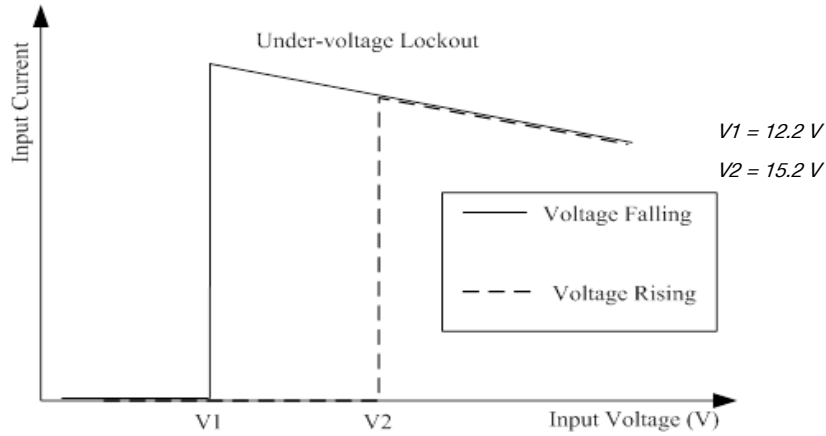

Figure 28. Input under-voltage lockout

14. THERMAL DERATING CURVES

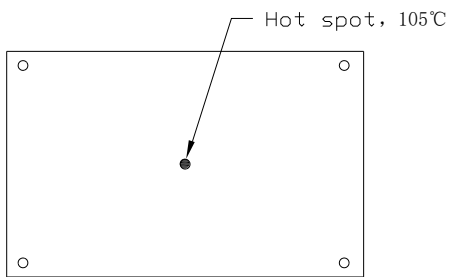

Figure 29. Module top view

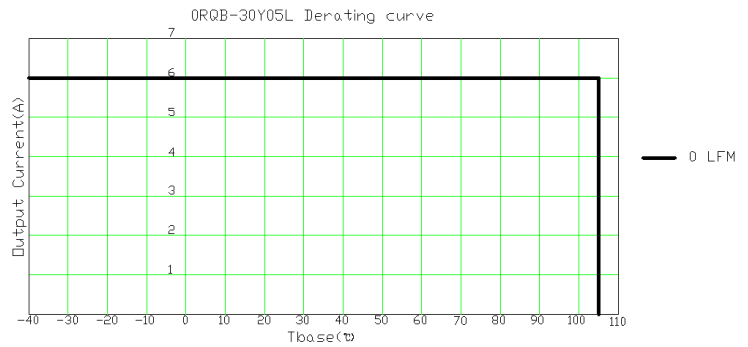

Figure 30. Thermal derating curve

15. SAFETY & EMC

Safety:

safety certificated to EN 62368-1
 CE certificated to Low Voltage Directive 2014/35/EU

EMC:

Conductive EMI: EN 55032 class A
 Compliance to EN 55032 class A (both peak and average) with the following inductive and capacitive filter
 Test setup:

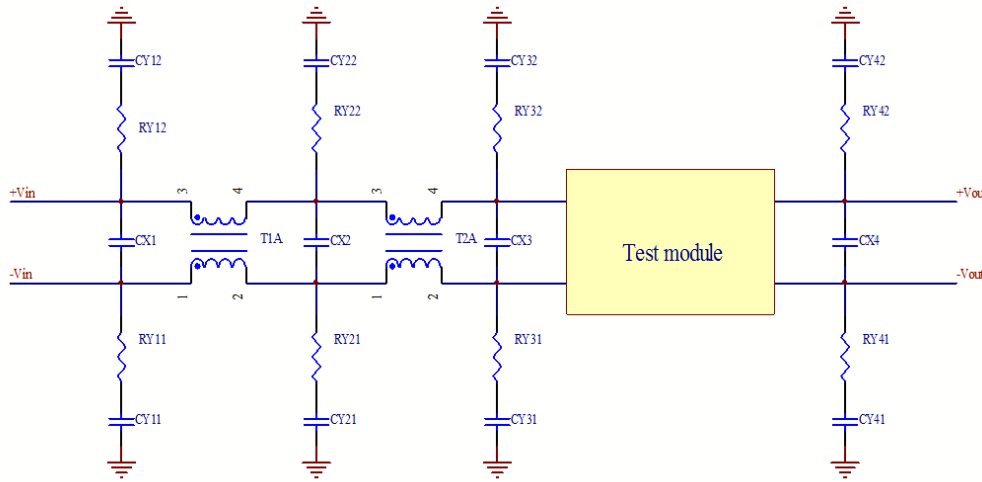

Figure 31.

ITEM	DESIGNATOR	PARAMETER	VENDOR	VENDOR P/N
1	CX1	100µF/200V, AL cap		
2	CX2	220µF/200V, AL cap		
2	CX3	220µF/200V, AL cap		
3	CX4	220µF/200V, AL cap		
3	CY21	0.22µF/1000V, ceramic		
4	CY22	0.22µF/1000V, ceramic		
7	RY21	1206,0 R, Resistor		
8	RY22	1206,0 R ,Resistor		
11	T2A	0.45mH, common mode		
12	T1A	0.9mH, common mode		
12	RY11,RY12,CY11,CY21, RY31,RY32,CY31,CY32 RY41,RY42,CY41,CY42	NIL		

Positive:

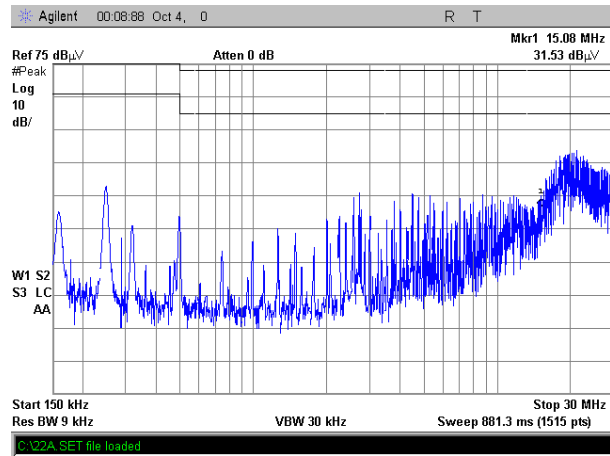

Figure 32.

Negative:

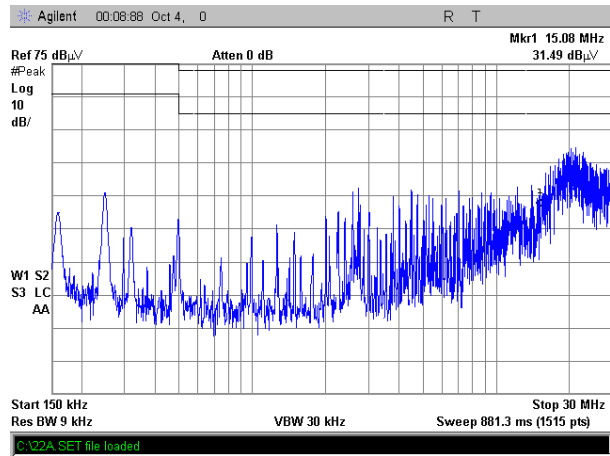

Figure 33.

16. MECHANICAL OUTLINE
OUTLINE

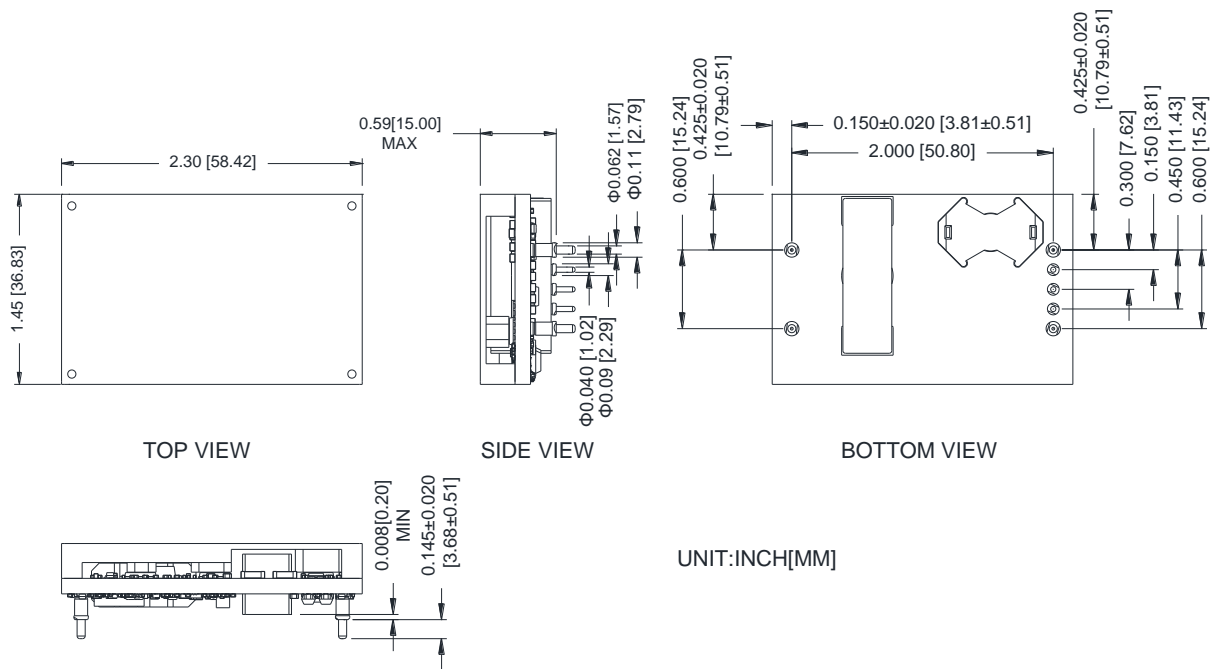

Figure 34. Outline

NOTE: This module is recommended and compatible with Pb-Free Wave Soldering and must be soldered using a peak solder temperature of no more than 260 °C for less than 5 seconds.

NOTES: 1) All Pins: Material - Copper Alloy;

Finish – Tin plated

2) Un-dimensioned components are shown for visual reference only.

3) All dimensions in inch [mm]; Tolerances: x.xx +/-0.02 inch [0.5 mm]; x.xxx +/-0.010 inch [0.25 mm].

PIN DEFINITIONS

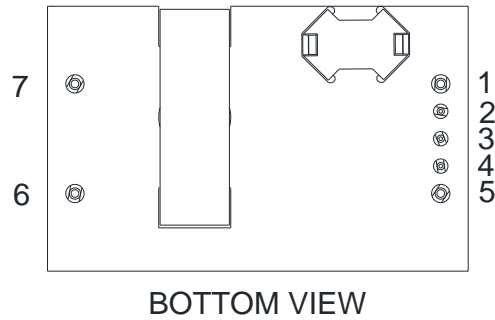
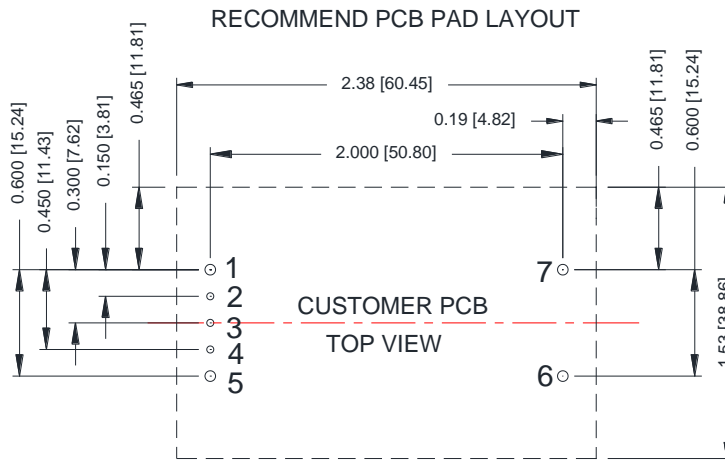

Figure 35. Pins

PIN	FUNCTION
1	Vin(+)
2	C_HOLD
3	ON/OFF
4	V_AUX(5V)
5	Vin(-)
6	Vout(-)
7	Vout(+)

RECOMMENDED PAD LAYOUT



2 3 4 HOLES SIZE $\Phi 0.050$ & PAD SIZE $\Phi 0.100$ MIN
 1 5 6 7 HOLES SIZE $\Phi 0.074$ & PAD SIZE $\Phi 0.120$ MIN

Figure 36. Recommended pad layout

17. REVISION HISTORY

DATE	REVISION	CHANGES DETAIL	APPROVAL
2014-11-12	A	First release	S.Wang
2015-12-23	B	1. Update rise time and turn on time 2. Update Efficiency value 3. Update waveform of electrical performance	S.Wang
2016-02-26	C	1. Change the operation temperature in Absolute Maximum Ratings 2. Add thermal resistance in Absolute Maximum Ratings	S.Wang
2016-04-21	D	Update Safety Certification, MTBF, Thermal Derating Curve, MD.	S.Wang
2018-04-28	AE	Update Operating Input Voltage Range 2, Under-voltage, MD, Turn off Threshold and Transient Response	S.Wang
2018-10-10	AF	Update hold-up circuit	S.Wang
2019-10-24	AG	Add feature reinforced isolation	S.Wang
2021-05-12	AH	Add object ID. Update safety certificate.	XF.Jiang

For more information on these products consult: tech.support@psbel.com

NUCLEAR AND MEDICAL APPLICATIONS - Products are not designed or intended for use as critical components in life support systems, equipment used in hazardous environments, or nuclear control systems.

TECHNICAL REVISIONS - The appearance of products, including safety agency certifications pictured on labels, may change depending on the date manufactured. Specifications are subject to change without notice.



Asia-Pacific
+86 755 298 85888

Europe, Middle East
+353 61 225 977

North America
+1 408 785 5200