

2N6387, 2N6388

Plastic Medium-Power Silicon Transistors

These devices are designed for general-purpose amplifier and low-speed switching applications.

Features

- High DC Current Gain – $h_{FE} = 2500$ (Typ) @ $I_C = 4.0$ Adc
- Collector–Emitter Sustaining Voltage – @ 100 mAcd
 $V_{CEO(sus)} = 60$ Vdc (Min) – 2N6387
 $= 80$ Vdc (Min) – 2N6388
- Low Collector–Emitter Saturation Voltage –
 $V_{CE(sat)} = 2.0$ Vdc (Max) @ $I_C = 5.0$ Adc – 2N6387, 2N6388
- Monolithic Construction with Built–In Base–Emitter Shunt Resistors
- TO–220AB Compact Package
- These Devices are Pb–Free and are RoHS Compliant*

MAXIMUM RATINGS (Note 1)

Rating	Symbol	Value	Unit
Collector–Emitter Voltage	2N6387 2N6388 V_{CEO}	60 80	Vdc
Collector–Base Voltage	2N6387 2N6388 V_{CB}	60 80	Vdc
Emitter–Base Voltage	V_{EB}	5.0	Vdc
Collector Current – Continuous – Peak	I_C	10 15	Adc
Base Current	I_B	250	mAcd
Total Power Dissipation @ $T_C = 25^\circ\text{C}$ Derate above 25°C	P_D	65 0.52	W W/ $^\circ\text{C}$
Total Power Dissipation @ $T_A = 25^\circ\text{C}$ Derate above 25°C	P_D	2.0 0.016	W W/ $^\circ\text{C}$
Operating and Storage Junction, Temperature Range	T_J, T_{stg}	–65 to +150	$^\circ\text{C}$

Stresses exceeding those listed in the Maximum Ratings table may damage the device. If any of these limits are exceeded, device functionality should not be assumed, damage may occur and reliability may be affected.

1. Indicates JEDEC Registered Data.

THERMAL CHARACTERISTICS

Characteristics	Symbol	Max	Unit
Thermal Resistance, Junction–to–Case	$R_{\theta JC}$	1.92	$^\circ\text{C/W}$
Thermal Resistance, Junction–to–Ambient	$R_{\theta JA}$	62.5	$^\circ\text{C/W}$

*For additional information on our Pb–Free strategy and soldering details, please download the ON Semiconductor Soldering and Mounting Techniques Reference Manual, SOLDERRM/D.



ON Semiconductor®

www.onsemi.com

DARLINGTON NPN SILICON POWER TRANSISTORS 8 AND 10 AMPERES 65 WATTS, 60 – 80 VOLTS

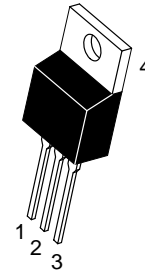

TO–220
CASE 221A
STYLE 1

MARKING DIAGRAM



2N638x = Device Code
x = 7 or 8

G = Pb–Free Package
A = Assembly Location
Y = Year
WW = Work Week

ORDERING INFORMATION

Device	Package	Shipping
2N6387G	TO–220 (Pb–Free)	50 Units / Rail
2N6388G	TO–220 (Pb–Free)	50 Units / Rail

2N6387, 2N6388

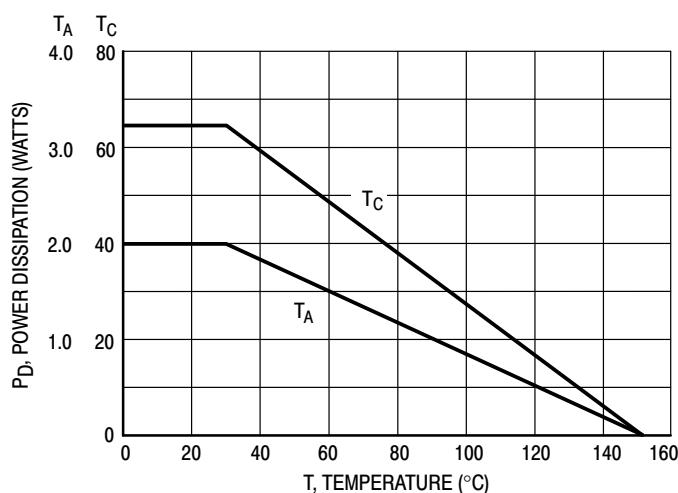

Figure 1. Power Derating

ELECTRICAL CHARACTERISTICS ($T_C = 25^\circ\text{C}$ unless otherwise noted) (Note 2)

Characteristic	Symbol	Min	Max	Unit	
OFF CHARACTERISTICS					
Collector–Emitter Sustaining Voltage (Note 3) ($I_C = 200\text{ mA}$, $I_B = 0$)	2N6387 2N6388	$V_{CE(sus)}$	60 80	– –	Vdc
Collector Cutoff Current ($V_{CE} = 60\text{ Vdc}$, $I_B = 0$) ($V_{CE} = 80\text{ Vdc}$, $I_B = 0$)	2N6387 2N6388	I_{CEO}	– –	1.0 1.0	mA
Collector Cutoff Current ($V_{CE} = 60\text{ Vdc}$, $V_{EB(off)} = 1.5\text{ Vdc}$) ($V_{CE} = 80\text{ Vdc}$, $V_{EB(off)} = 1.5\text{ Vdc}$) ($V_{CE} = 60\text{ Vdc}$, $V_{EB(off)} = 1.5\text{ Vdc}$, $T_C = 125^\circ\text{C}$) ($V_{CE} = 80\text{ Vdc}$, $V_{EB(off)} = 1.5\text{ Vdc}$, $T_C = 125^\circ\text{C}$)	2N6387 2N6388 2N6387 2N6388	I_{CEX}	– – – –	300 300 3.0 3.0	μA mA
Emitter Cutoff Current ($V_{BE} = 5.0\text{ Vdc}$, $I_C = 0$)		I_{EBO}	–	5.0	mA
ON CHARACTERISTICS (Note 3)					
DC Current Gain ($I_C = 5.0\text{ A}$, $V_{CE} = 3.0\text{ Vdc}$) ($I_C = 1.0\text{ A}$, $V_{CE} = 3.0\text{ Vdc}$)	2N6387, 2N6388 2N6387, 2N6388	h_{FE}	1000 100	20,000 –	–
Collector–Emitter Saturation Voltage ($I_C = 5.0\text{ A}$, $I_B = 0.01\text{ A}$) ($I_C = 1.0\text{ A}$, $I_B = 0.1\text{ A}$)	2N6387, 2N6388 2N6387, 2N6388	$V_{CE(sat)}$	– –	2.0 3.0	Vdc
Base–Emitter On Voltage ($I_C = 5.0\text{ A}$, $V_{CE} = 3.0\text{ Vdc}$) ($I_C = 1.0\text{ A}$, $V_{CE} = 3.0\text{ Vdc}$)	2N6387, 2N6388 2N6387, 2N6388	$V_{BE(on)}$	– –	2.8 4.5	Vdc
DYNAMIC CHARACTERISTICS					
Small–Signal Current Gain ($I_C = 1.0\text{ A}$, $V_{CE} = 5.0\text{ Vdc}$, $f_{test} = 1.0\text{ MHz}$)		$ h_{fe} $	20	–	–
Output Capacitance ($V_{CB} = 10\text{ Vdc}$, $I_E = 0$, $f = 1.0\text{ MHz}$)		C_{ob}	–	200	pF
Small–Signal Current Gain ($I_C = 1.0\text{ A}$, $V_{CE} = 5.0\text{ Vdc}$, $f = 1.0\text{ kHz}$)		h_{fe}	1000	–	–

Product parametric performance is indicated in the Electrical Characteristics for the listed test conditions, unless otherwise noted. Product performance may not be indicated by the Electrical Characteristics if operated under different conditions.

2. Indicates JEDEC Registered Data.

3. Pulse Test: Pulse Width $\leq 300\ \mu\text{s}$, Duty Cycle $\leq 2.0\%$.

2N6387, 2N6388

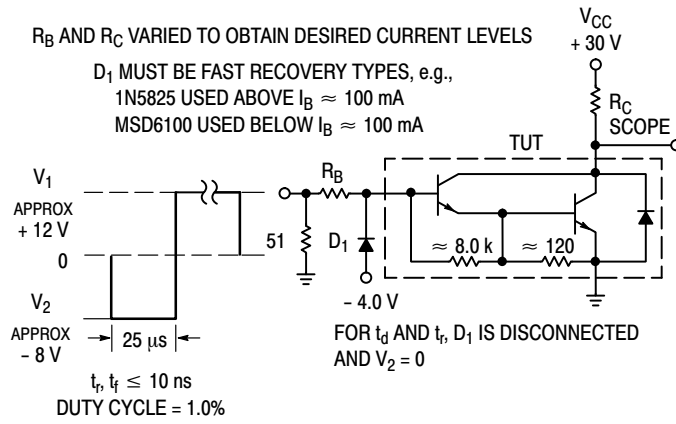

Figure 2. Switching Times Test Circuit

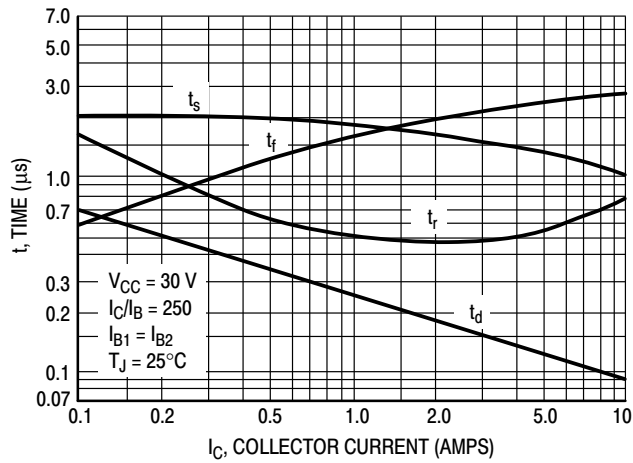

Figure 3. Switching Times

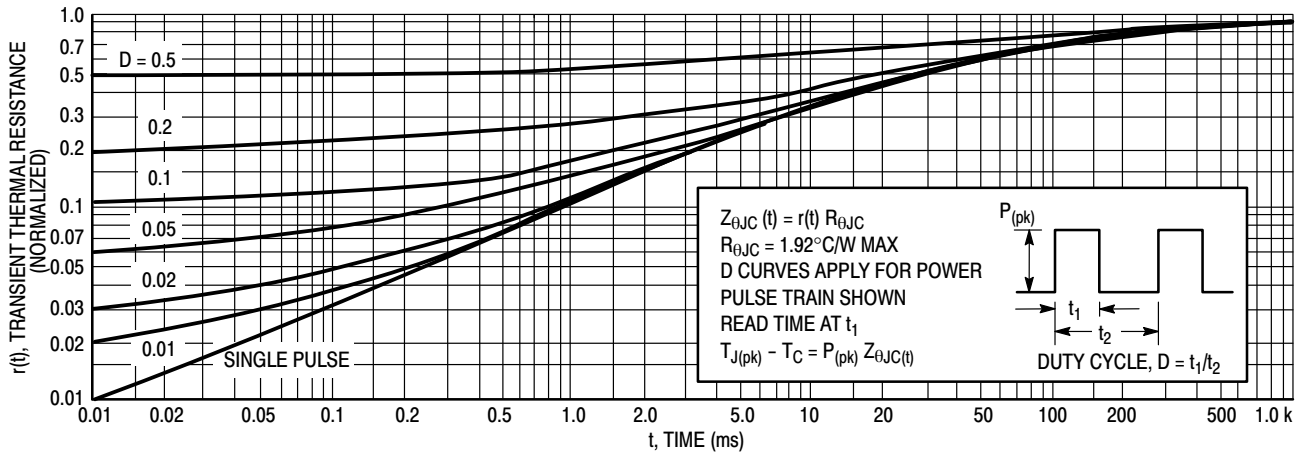

Figure 4. Thermal Response

2N6387, 2N6388

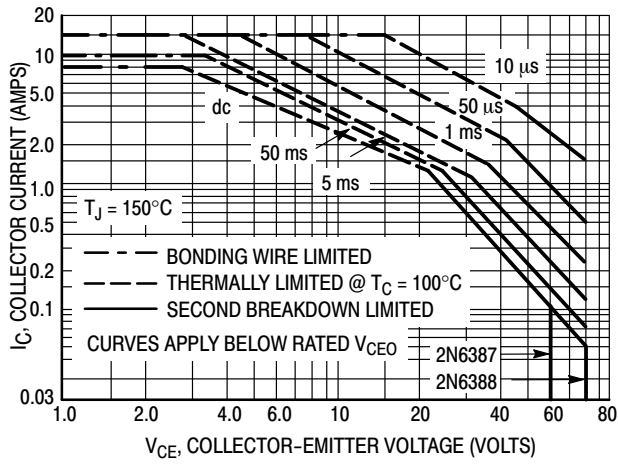

Figure 5. Active-Region Safe Operating Area

There are two limitations on the power handling ability of a transistor: average junction temperature and second breakdown. Safe operating area curves indicate $I_C - V_{CE}$ limits of the transistor that must be observed for reliable operation; i.e., the transistor must not be subjected to greater dissipation than the curves indicate.

The data of Figure 5 is based on $T_{J(pk)} = 150^\circ\text{C}$; T_C is variable depending on conditions. Second breakdown pulse limits are valid for duty cycles to 10% provided $T_{J(pk)} < 150^\circ\text{C}$. $T_{J(pk)}$ may be calculated from the data in Figure 4. At high case temperatures, thermal limitations will reduce the power that can be handled to values less than the limitations imposed by second breakdown

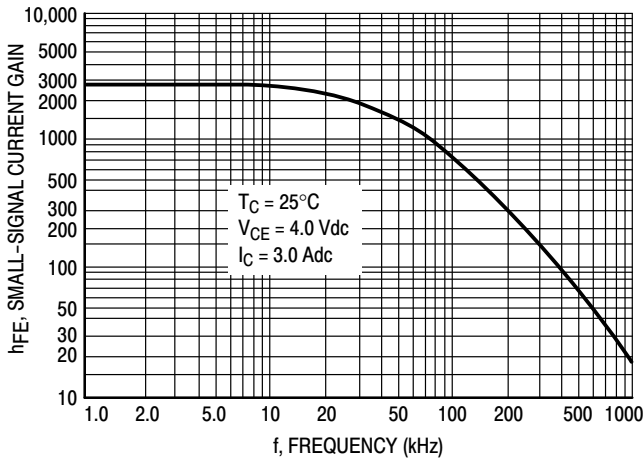

Figure 6. Small-Signal Current Gain

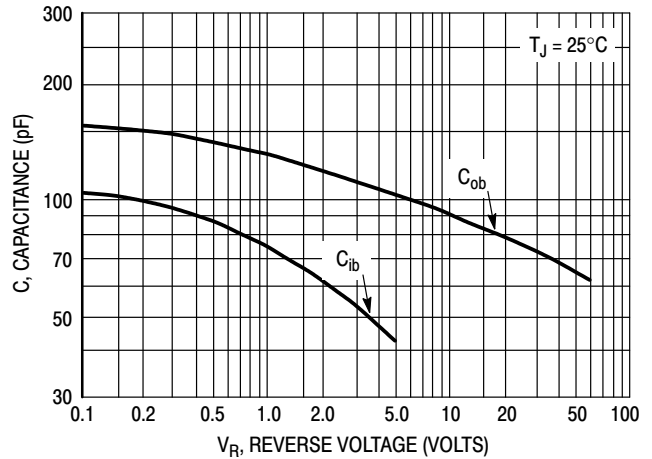

Figure 7. Capacitance

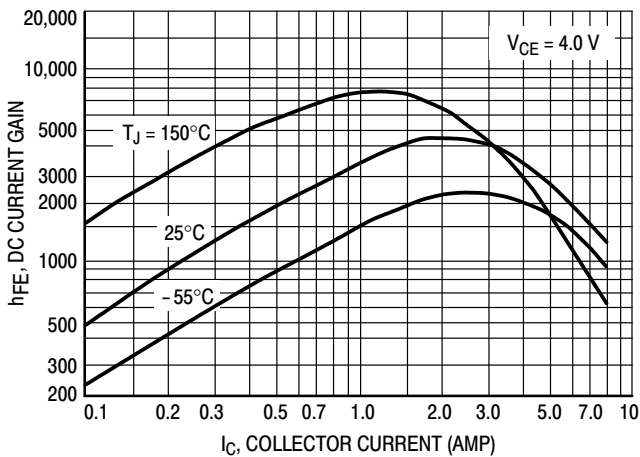

Figure 8. DC Current Gain

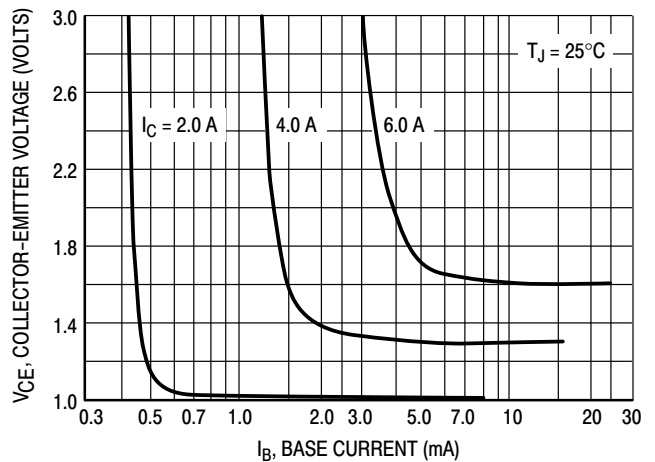

Figure 9. Collector Saturation Region

2N6387, 2N6388

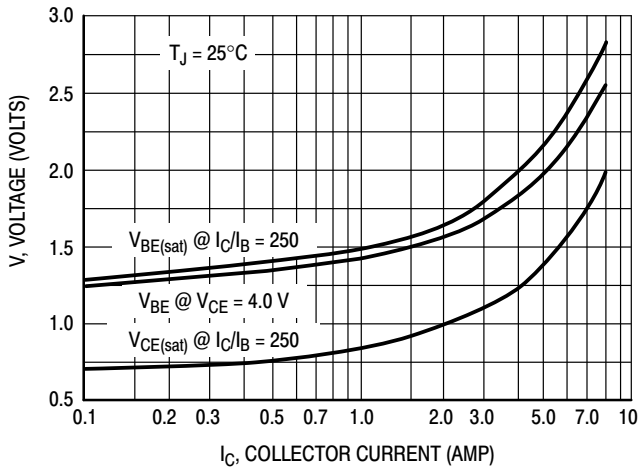

Figure 10. "On" Voltages

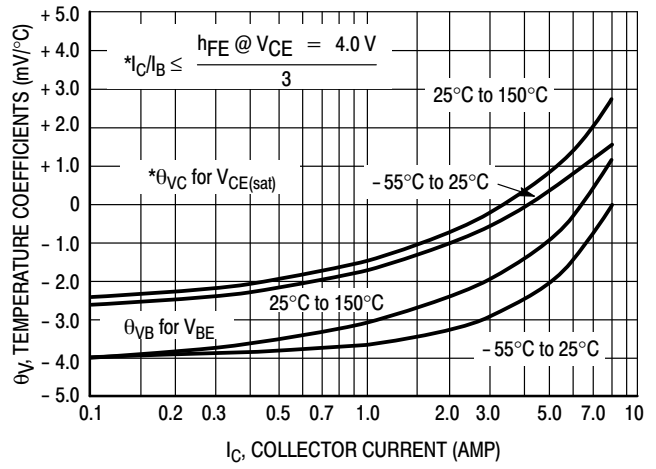

Figure 11. Temperature Coefficients

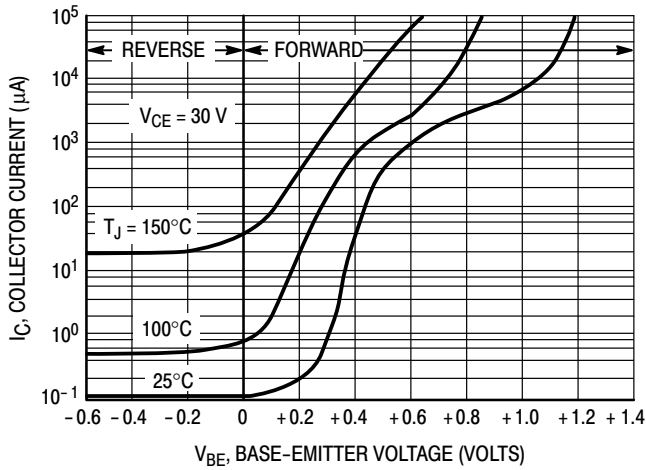

Figure 12. Collector Cut-Off Region

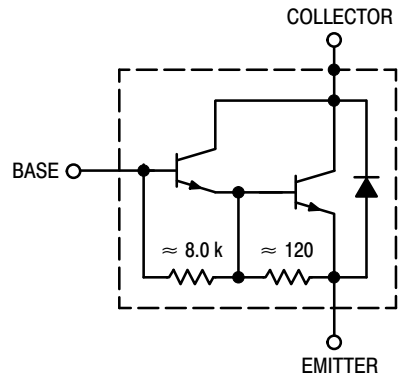
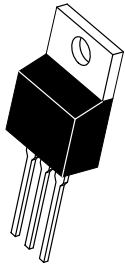

Figure 13. Darlington Schematic

MECHANICAL CASE OUTLINE PACKAGE DIMENSIONS



SCALE 1:1



TO-220 CASE 221A ISSUE AK

DATE 13 JAN 2022

NOTES:

1. DIMENSIONING AND TOLERANCING PER ANSI Y14.5M, 2009.
2. CONTROLLING DIMENSION: INCHES
3. DIMENSION Z DEFINES A ZONE WHERE ALL BODY AND LEAD IRREGULARITIES ARE ALLOWED.
4. MAX WIDTH FOR F102 DEVICE = 1.35MM

DIM	INCHES		MILLIMETERS	
	MIN.	MAX.	MIN.	MAX.
A	0.570	0.620	14.48	15.75
B	0.380	0.415	9.66	10.53
C	0.160	0.190	4.07	4.83
D	0.025	0.038	0.64	0.96
F	0.142	0.161	3.60	4.09
G	0.095	0.105	2.42	2.66
H	0.110	0.161	2.80	4.10
J	0.014	0.024	0.36	0.61
K	0.500	0.562	12.70	14.27
L	0.045	0.060	1.15	1.52
N	0.190	0.210	4.83	5.33
Q	0.100	0.120	2.54	3.04
R	0.080	0.110	2.04	2.79
S	0.045	0.055	1.15	1.41
T	0.235	0.255	5.97	6.47
U	0.000	0.050	0.00	1.27
V	0.045	---	1.15	---
Z	---	0.080	---	2.04

STYLE 1:
PIN 1. BASE
2. COLLECTOR
3. EMITTER
4. COLLECTOR

STYLE 2:
PIN 1. BASE
2. EMITTER
3. COLLECTOR
4. EMITTER

STYLE 3:
PIN 1. CATHODE
2. ANODE
3. GATE
4. ANODE

STYLE 4:
PIN 1. MAIN TERMINAL 1
2. MAIN TERMINAL 2
3. GATE
4. MAIN TERMINAL 2

STYLE 5:
PIN 1. GATE
2. DRAIN
3. SOURCE
4. DRAIN

STYLE 6:
PIN 1. ANODE
2. CATHODE
3. ANODE
4. CATHODE

STYLE 7:
PIN 1. CATHODE
2. ANODE
3. CATHODE
4. ANODE

STYLE 8:
PIN 1. CATHODE
2. ANODE
3. EXTERNAL TRIP/DELAY
4. ANODE

STYLE 9:
PIN 1. GATE
2. COLLECTOR
3. EMITTER
4. COLLECTOR

STYLE 10:
PIN 1. GATE
2. SOURCE
3. DRAIN
4. SOURCE

STYLE 11:
PIN 1. DRAIN
2. SOURCE
3. GATE
4. SOURCE

STYLE 12:
PIN 1. MAIN TERMINAL 1
2. MAIN TERMINAL 2
3. GATE
4. NOT CONNECTED

DOCUMENT NUMBER:	98ASB42148B	Electronic versions are uncontrolled except when accessed directly from the Document Repository. Printed versions are uncontrolled except when stamped "CONTROLLED COPY" in red.
DESCRIPTION:	TO-220	PAGE 1 OF 1

onsemi and onsemi are trademarks of Semiconductor Components Industries, LLC dba onsemi or its subsidiaries in the United States and/or other countries. onsemi reserves the right to make changes without further notice to any products herein. onsemi makes no warranty, representation or guarantee regarding the suitability of its products for any particular purpose, nor does onsemi assume any liability arising out of the application or use of any product or circuit, and specifically disclaims any and all liability, including without limitation special, consequential or incidental damages. onsemi does not convey any license under its patent rights nor the rights of others.

onsemi, **Onsemi**, and other names, marks, and brands are registered and/or common law trademarks of Semiconductor Components Industries, LLC dba "**onsemi**" or its affiliates and/or subsidiaries in the United States and/or other countries. **onsemi** owns the rights to a number of patents, trademarks, copyrights, trade secrets, and other intellectual property. A listing of **onsemi**'s product/patent coverage may be accessed at www.onsemi.com/site/pdf/Patent-Marking.pdf. **onsemi** reserves the right to make changes at any time to any products or information herein, without notice. The information herein is provided "as-is" and **onsemi** makes no warranty, representation or guarantee regarding the accuracy of the information, product features, availability, functionality, or suitability of its products for any particular purpose, nor does **onsemi** assume any liability arising out of the application or use of any product or circuit, and specifically disclaims any and all liability, including without limitation special, consequential or incidental damages. Buyer is responsible for its products and applications using **onsemi** products, including compliance with all laws, regulations and safety requirements or standards, regardless of any support or applications information provided by **onsemi**. "Typical" parameters which may be provided in **onsemi** data sheets and/or specifications can and do vary in different applications and actual performance may vary over time. All operating parameters, including "Typicals" must be validated for each customer application by customer's technical experts. **onsemi** does not convey any license under any of its intellectual property rights nor the rights of others. **onsemi** products are not designed, intended, or authorized for use as a critical component in life support systems or any FDA Class 3 medical devices or medical devices with a same or similar classification in a foreign jurisdiction or any devices intended for implantation in the human body. Should Buyer purchase or use **onsemi** products for any such unintended or unauthorized application, Buyer shall indemnify and hold **onsemi** and its officers, employees, subsidiaries, affiliates, and distributors harmless against all claims, costs, damages, and expenses, and reasonable attorney fees arising out of, directly or indirectly, any claim of personal injury or death associated with such unintended or unauthorized use, even if such claim alleges that **onsemi** was negligent regarding the design or manufacture of the part. **onsemi** is an Equal Opportunity/Affirmative Action Employer. This literature is subject to all applicable copyright laws and is not for resale in any manner.

PUBLICATION ORDERING INFORMATION

LITERATURE FULFILLMENT:

Email Requests to: orderlit@onsemi.com

onsemi Website: www.onsemi.com

TECHNICAL SUPPORT

North American Technical Support:

Voice Mail: 1 800-282-9855 Toll Free USA/Canada

Phone: 011 421 33 790 2910

Europe, Middle East and Africa Technical Support:

Phone: 00421 33 790 2910

For additional information, please contact your local Sales Representative