

V_R	650V
I_F	15A
Q_C	37nC

●Features

- 1) Shorter recovery time
- 2) Reduced temperature dependence
- 3) High-speed switching possible
- 4) High surge current capability

●Applications

- PFC Boost Topology
- Secondary Side Rectification
- Data Center
- PV Power Conditioners

●Absolute maximum ratings ($T_j = 25^\circ\text{C}$)

Parameter		Symbol	Value	Unit
Reverse voltage (repetitive peak)		V_{RM}	650	V
Reverse voltage (DC)		V_R	650	V
Continuous forward current ($T_c = 65^\circ\text{C}$)		I_F	15	A
Surge non-repetitive forward current	PW=10ms sinusoidal, $T_j=25^\circ\text{C}$	I_{FSM}	112	A
	PW=10ms sinusoidal, $T_j=150^\circ\text{C}$		95	A
	PW=10μs square, $T_j=25^\circ\text{C}$		410	A
Repetitive peak forward current		I_{FRM}	39 ^{*1}	A
i^2t value	$1 \leq PW \leq 10\text{ms}$, $T_j=25^\circ\text{C}$	$\int i^2 dt$	62	A ² s
	$1 \leq PW \leq 10\text{ms}$, $T_j=150^\circ\text{C}$		45	A ² s
Total power dissipation		P_D	39 ^{*2}	W
Junction temperature		T_j	175	°C
Range of storage temperature		T_{stg}	-55 to +175	°C

*1 $T_c=100^\circ\text{C}$, $T_j=150^\circ\text{C}$, Duty cycle=10% *2 $T_c=25^\circ\text{C}$

●Outline

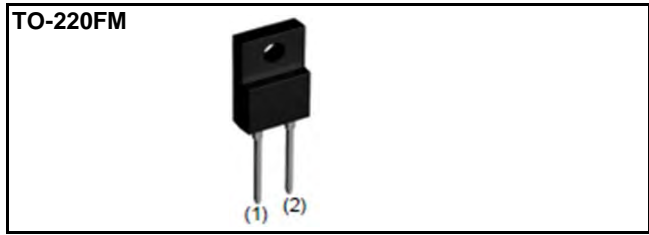

●Inner circuit

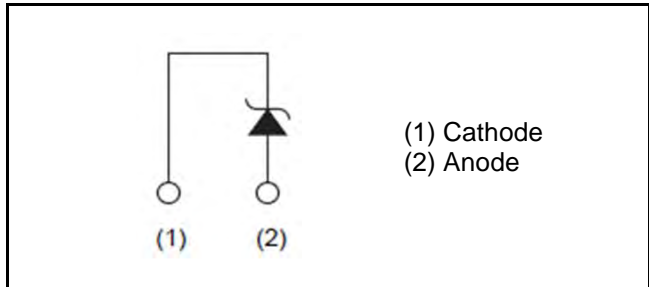

●Packaging specifications

Type	Packaging	Tube
	Reel size (mm)	-
	Tape width (mm)	-
	Basic ordering unit (pcs)	50
	Packing code	C
	Marking	SCS315AM

●Electrical characteristics ($T_j = 25^\circ\text{C}$)

Parameter	Symbol	Conditions	Values			Unit
			Min.	Typ.	Max.	
DC blocking voltage	V_{DC}	$I_R = 75\mu\text{A}$	650	-	-	V
Forward voltage	V_F	$I_F = 15\text{A}, T_j = 25^\circ\text{C}$	-	1.35	1.50	V
		$I_F = 15\text{A}, T_j = 150^\circ\text{C}$	-	1.44	1.71	V
		$I_F = 15\text{A}, T_j = 175^\circ\text{C}$	-	1.50	-	V
Reverse current	I_R	$V_R = 650\text{V}, T_j = 25^\circ\text{C}$	-	0.045	75	μA
		$V_R = 650\text{V}, T_j = 150^\circ\text{C}$	-	3	300	μA
		$V_R = 650\text{V}, T_j = 175^\circ\text{C}$	-	9	-	μA
Total capacitance	C	$V_R = 1\text{V}, f = 1\text{MHz}$	-	750	-	pF
		$V_R = 650\text{V}, f = 1\text{MHz}$	-	68	-	pF
Total capacitive charge	Q_C	$V_R = 400\text{V}, di/dt = 350\text{A}/\mu\text{s}$	-	37	-	nC
Switching time	t_C	$V_R = 400\text{V}, di/dt = 350\text{A}/\mu\text{s}$	-	21	-	ns
Non-repetitive Avaranche Energy	E_{ava}	$L = 1\text{mH}$	-	210	-	mJ

●Thermal characteristics

Parameter	Symbol	Conditions	Values			Unit
			Min.	Typ.	Max.	
Thermal resistance	$R_{th(j-c)}$	-	-	3.3	3.8	$^\circ\text{C}/\text{W}$

●Typical Transient Thermal Characteristics

Symbol	Value	Unit	Symbol	Value	Unit
R_{th1}	1.84E-01	K/W	C_{th1}	7.21E-04	Ws/K
R_{th2}	8.85E-01		C_{th2}	3.77E-03	
R_{th3}	2.23E+00		C_{th3}	3.32E-01	

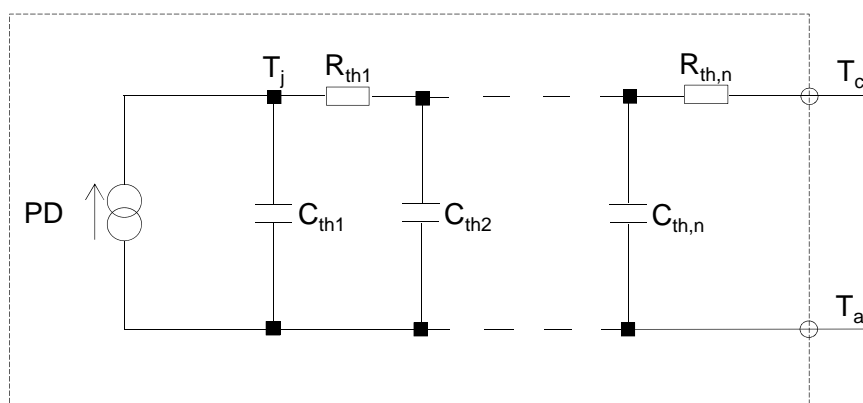

●Electrical characteristic curves

Fig.1 $V_F - I_F$ Characteristics

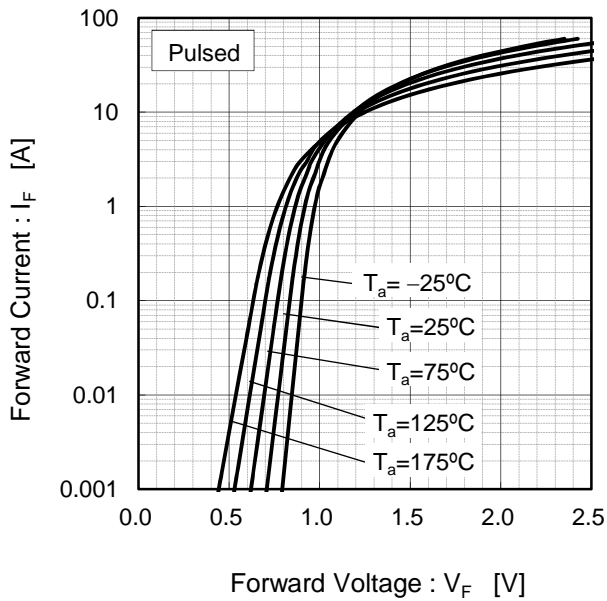

Fig.2 $V_F - I_F$ Characteristics

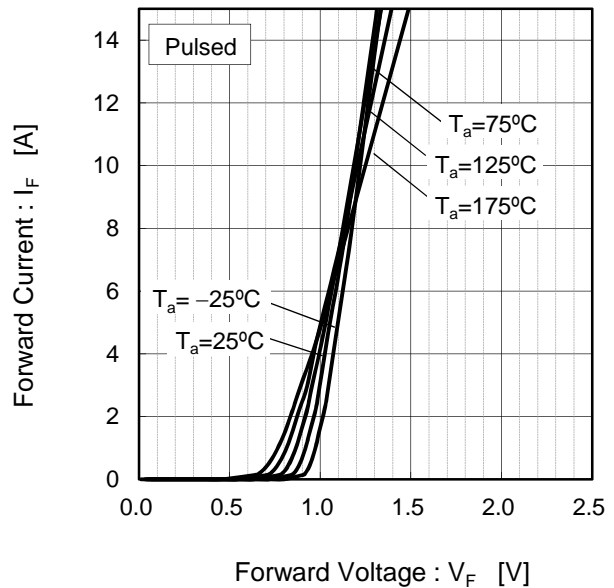

Fig.3 $V_R - I_R$ Characteristics

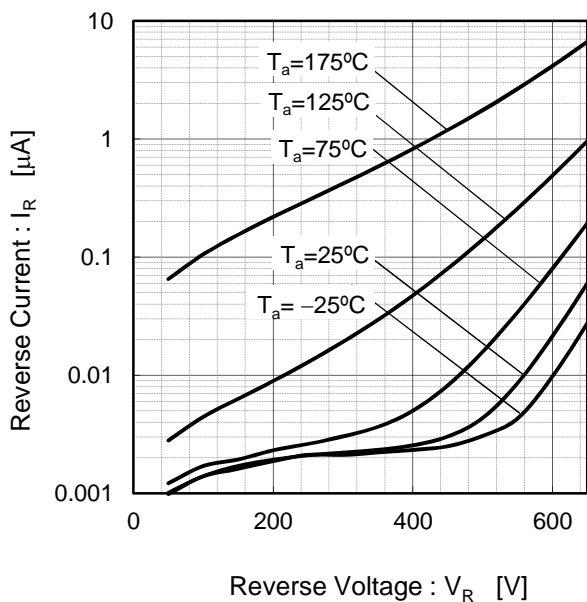
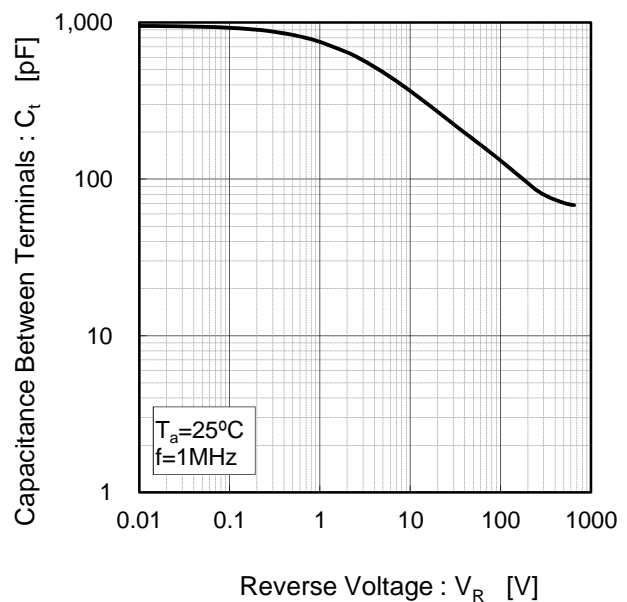

Fig.4 $V_R - C_t$ Characteristics



●Electrical characteristic curves

Fig.5 Typical Transient Thermal Resistance vs. Pulse Width

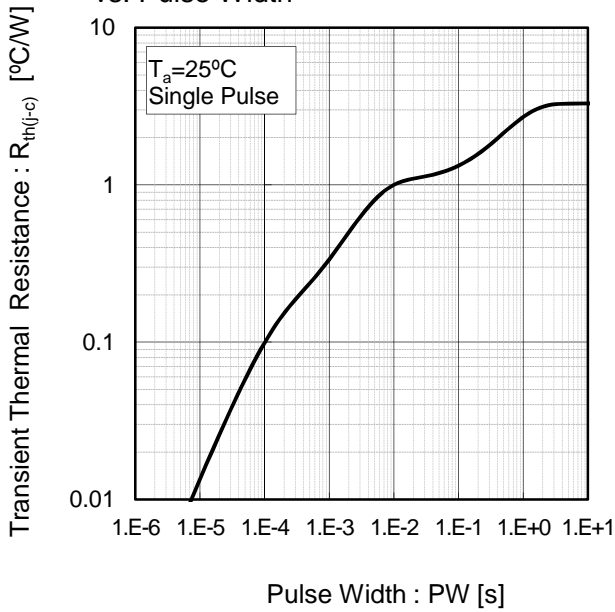

Fig.6 Power Dissipation

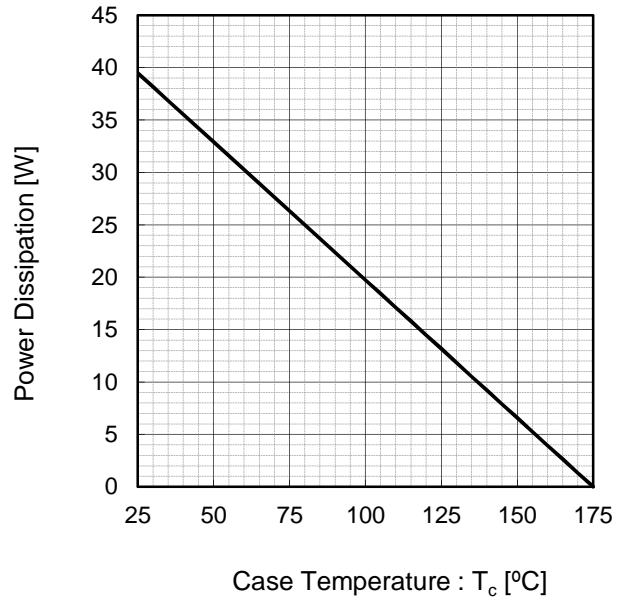
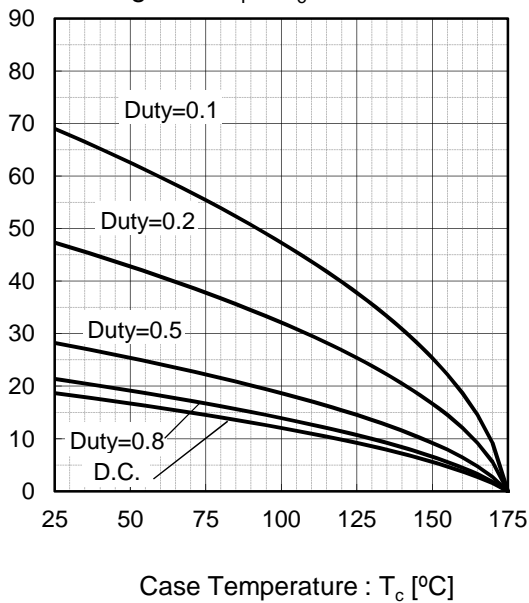
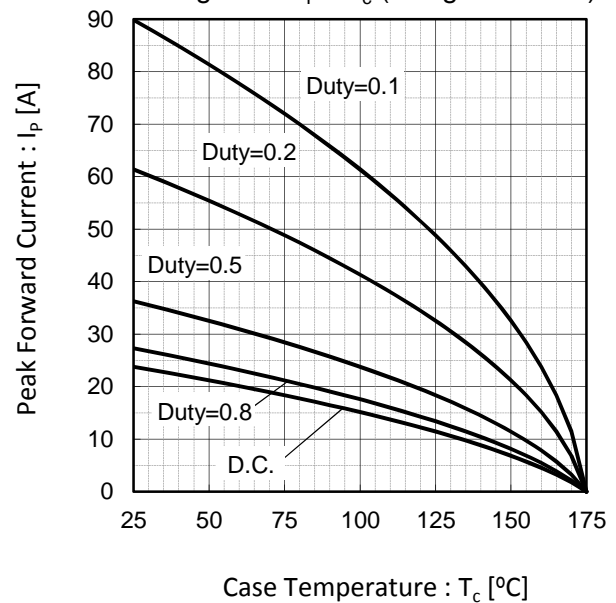

Fig.7*3 Maximum peak forward current derating curve $I_P - T_c$



*3 Based on max V_f , max $R_{th(j-c)}$
Valid for switching of above 10kHz,
excluding D.C. curve.

Fig.8*4 Typical peak forward current derating curve $I_P - T_c$ (Not guaranteed)



*4 Based on typ V_f , typ $R_{th(j-c)}$
Typical value, not guaranteed
Valid for switching of above 10kHz,
excluding D.C. curve

●Electrical characteristic curves

Fig.9 Surge non-repetitive forward current vs. Pulse width (Sinusoidal waveform)

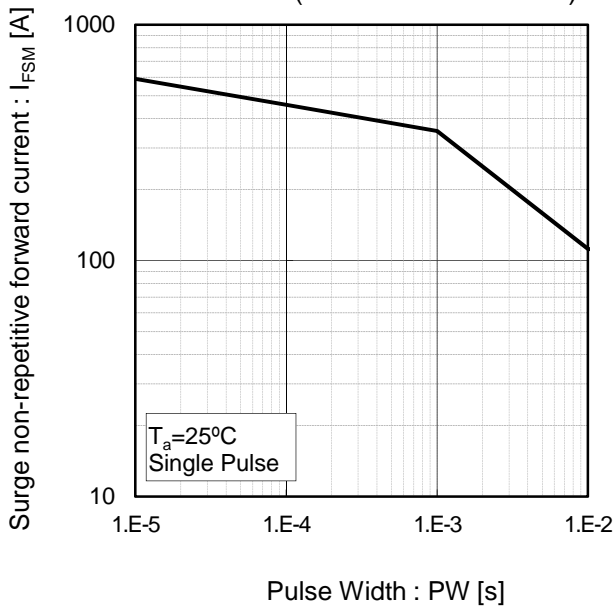
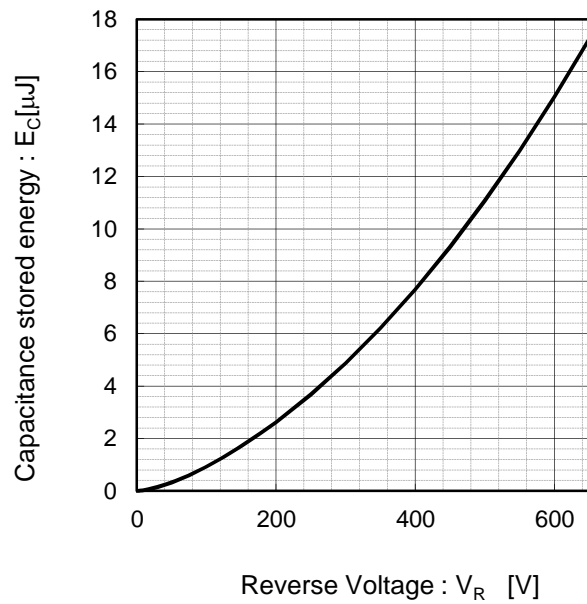
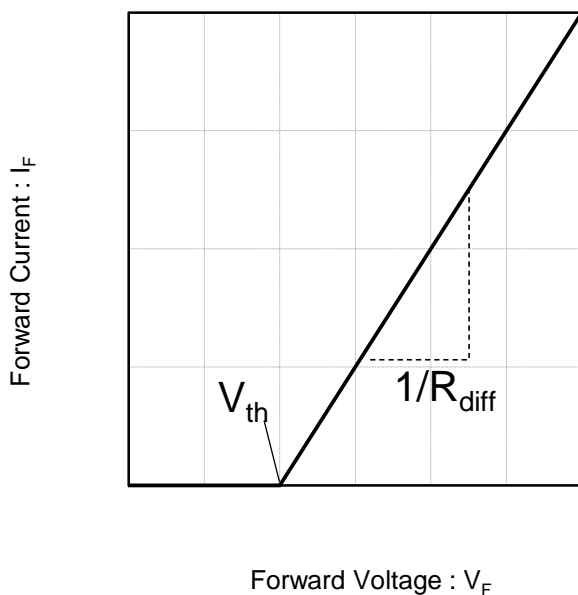

Fig.10 Typical capacitance store energy



●Simplified forward characteristic model

Fig.11 Equivalent forward current curve



$$V_F = V_{th} + R_{diff} I_F$$

$$V_{th}(T_j) = a_0 + a_1 T_j$$

$$R_{diff}(T_j) = b_0 + b_1 T_j + b_2 T_j^2$$

Symbol	Typical Value	Unit
a_0	9.66E-01	V
a_1	-1.10E-03	V/°C
b_0	2.35E-02	Ω
b_1	4.97E-05	Ω/°C
b_2	5.12E-07	Ω/°C ²

T_j in °C; -55 °C < T_j < 175°C ; I_F < 30 A

Notes

- 1) The information contained herein is subject to change without notice.
- 2) Before you use our Products, please contact our sales representative and verify the latest specifications :
- 3) Although ROHM is continuously working to improve product reliability and quality, semiconductors can break down and malfunction due to various factors.
Therefore, in order to prevent personal injury or fire arising from failure, please take safety measures such as complying with the derating characteristics, implementing redundant and fire prevention designs, and utilizing backups and fail-safe procedures. ROHM shall have no responsibility for any damages arising out of the use of our Products beyond the rating specified by ROHM.
- 4) Examples of application circuits, circuit constants and any other information contained herein are provided only to illustrate the standard usage and operations of the Products. The peripheral conditions must be taken into account when designing circuits for mass production.
- 5) The technical information specified herein is intended only to show the typical functions of and examples of application circuits for the Products. ROHM does not grant you, explicitly or implicitly, any license to use or exercise intellectual property or other rights held by ROHM or any other parties. ROHM shall have no responsibility whatsoever for any dispute arising out of the use of such technical information.
- 6) The Products specified in this document are not designed to be radiation tolerant.
- 7) For use of our Products in applications requiring a high degree of reliability (as exemplified below), please contact and consult with a ROHM representative : transportation equipment (i.e. cars, ships, trains), primary communication equipment, traffic lights, fire/crime prevention, safety equipment, medical systems, and power transmission systems.
- 8) Do not use our Products in applications requiring extremely high reliability, such as aerospace equipment, nuclear power control systems, and submarine repeaters.
- 9) ROHM shall have no responsibility for any damages or injury arising from non-compliance with the recommended usage conditions and specifications contained herein.
- 10) ROHM has used reasonable care to ensure the accuracy of the information contained in this document. However, ROHM does not warrant that such information is error-free, and ROHM shall have no responsibility for any damages arising from any inaccuracy or misprint of such information.
- 11) Please use the Products in accordance with any applicable environmental laws and regulations, such as the RoHS Directive. For more details, including RoHS compatibility, please contact a ROHM sales office. ROHM shall have no responsibility for any damages or losses resulting from non-compliance with any applicable laws or regulations.
- 12) When providing our Products and technologies contained in this document to other countries, you must abide by the procedures and provisions stipulated in all applicable export laws and regulations, including without limitation the US Export Administration Regulations and the Foreign Exchange and Foreign Trade Act.
- 13) This document, in part or in whole, may not be reprinted or reproduced without prior consent of ROHM.



Thank you for your accessing to ROHM product informations.
More detail product informations and catalogs are available, please contact us.

ROHM Customer Support System

<http://www.rohm.com/contact/>