

IGBT - Field Stop, Trench

650 V, 75 A

Product Preview

FGH75T65SHDTLN4

Using the novel field stop 3rd generation IGBT technology, FGH75T65SHDTLN4 offers the optimum performance for solar inverter, UPS, welder, telecom, ESS and PFC applications where low conduction loss and switching loss are essential.

Features

- Maximum Junction Temperature: $T_J = 175^\circ\text{C}$
- Positive Temperature Co-efficient for Easy Parallel Operating
- High Current Capability
- Low Saturation Voltage: $V_{CE(\text{Sat})} = 1.6\text{ V (Typ.) @ } I_C = 75\text{ A}$
- 100% of the Parts Tested for $I_{LM}(1)$
- High Input Impedance
- Fast Switching
- Tight Parameter Distribution
- Pb Free and RoHS Compliant
- Not Recommended for Reflow and Full PKG Dipping

Typical Applications

- Solar Inverter • UPS • Welder
- Telecom • ESS • PFC

MAXIMUM RATINGS ($T_J = 25^\circ\text{C}$ unless otherwise noted)

Parameter	Symbol	Value	Unit	
Collector-to-Emitter Voltage	V_{CES}	650	V	
Gate-to-Emitter Voltage Transient Gate-to-Emitter Voltage	V_{GES}	± 20 ± 30	V	
Collector Current	I_C	$T_C = 25^\circ\text{C}$	150	A
		$T_C = 100^\circ\text{C}$	75	
Pulsed Collector Current (Note 1)	I_{LM}	300	A	
Pulsed Collector Maximum Current (Note 2)	I_{CM}	300	A	
Diode Forward Current	I_F	$T_C = 25^\circ\text{C}$	125	A
		$T_C = 100^\circ\text{C}$	75	
Pulsed Diode Maximum Forward Current (Note 2)	I_{FM}	300	A	
Maximum Power Dissipation	P_D	$T_C = 25^\circ\text{C}$	455	W
		$T_C = 100^\circ\text{C}$	227	
Operating Junction and Storage Temperature Range	T_J, T_{STG}	-55 to +175	$^\circ\text{C}$	
Maximum Lead Temperature for Soldering Purposes (1/8" from case for 5 seconds)	T_L	300	$^\circ\text{C}$	

Stresses exceeding those listed in the Maximum Ratings table may damage the device. If any of these limits are exceeded, device functionality should not be assumed, damage may occur and reliability may be affected.

1. $V_{CC} = 400\text{ V}$, $V_{GE} = 15\text{ V}$, $I_C = 300\text{ A}$, $R_G = 73\ \Omega$, Inductive Load
2. Repetitive rating: pulse width limited by max. Junction temperature

This document contains information on a product under development. ON Semiconductor reserves the right to change or discontinue this product without notice.



ON Semiconductor®

www.onsemi.com

75 A, 650 V
 $V_{CE(\text{sat})} = 1.6\text{ V}$
 $E_{\text{on}} = 1.06\text{ mJ}$

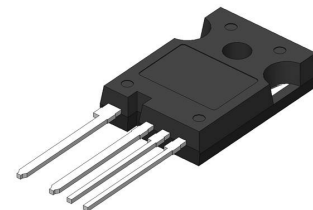
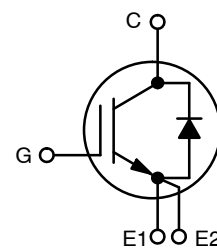

TO-247
THIN LEADS
CASE 340CW

DEVICE MARKING INFORMATION

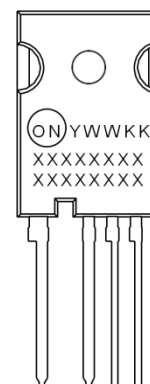

Line 1: Date Code
 Line 2: Device Marking
 Line 3: Device Marking

ORDERING INFORMATION

Device	Package	Shipping
FGH75T65SHDTLN4	TO-247	30 Units / Tube

FGH75T65SHDTLN4

Table 1. THERMAL CHARACTERISTICS

Symbol	Parameter	Value	Unit
$R_{\theta JC}$	Thermal Resistance, Junction to Case, for IGBT	0.33	$^{\circ}\text{C}/\text{W}$
$R_{\theta JC}$	Thermal Resistance, Junction to Case, for Diode	0.65	$^{\circ}\text{C}/\text{W}$
$R_{\theta JA}$	Thermal Resistance, Junction to Ambient	40	$^{\circ}\text{C}/\text{W}$

Table 2. ELECTRICAL CHARACTERISTICS ($T_J = 25^{\circ}\text{C}$ unless otherwise noted)

Parameter	Symbol	Test Condition	Min	Typ	Max	Unit
-----------	--------	----------------	-----	-----	-----	------

OFF CHARACTERISTICS

Collector-emitter breakdown voltage, gate-emitter short-circuited	BV_{CES}	$V_{GE} = 0\text{ V}, I_C = 1\text{ mA}$	650	-	-	V
Temperature Coefficient of Breakdown Voltage	$\Delta BV_{CES}/\Delta T_J$	$V_{GE} = 0\text{ V}, I_C = 1\text{ mA}$	-	0.65	-	$\text{V}/^{\circ}\text{C}$
Collector-emitter cut-off current, gate-emitter short-circuited	I_{CES}	$V_{GE} = 0\text{ V}, V_{CE} = 650\text{ V}$	-	-	250	μA
Gate leakage current, collector-emitter short-circuited	I_{GES}	$V_{GE} = \pm 20\text{ V}, V_{CE} = 0\text{ V}$	-	-	± 400	nA

ON CHARACTERISTICS

Gate-emitter threshold voltage	$V_{GE(th)}$	$V_{GE} = V_{CE}, I_C = 75\text{ mA}$	4.0	5.5	7.5	V
Collector-emitter saturation voltage	$V_{CE(sat)}$	$V_{GE} = 15\text{ V}, I_C = 75\text{ A}, V_{GE} = 15\text{ V}, I_C = 75\text{ A}, T_J = 175^{\circ}\text{C}$	-	1.6 2.28	2.1 -	$\text{mV}/^{\circ}\text{C}$

DYNAMIC CHARACTERISTICS

Input Capacitance	C_{ies}	$V_{CE} = 30\text{ V}, V_{GE} = 0\text{ V}, f = 1\text{ MHz}$	-	3710	-	pF
Output Capacitance	C_{oes}		-	183	-	
Reverse Transfer Capacitance	C_{res}		-	43	-	
Gate Charge Total	Q_g	$V_{CE} = 400\text{ V}, I_C = 75\text{ A}, V_{GE} = 15\text{ V}$	-	126	-	nC
Gate-to-Emitter Charge	Q_{ge}		-	24.1	-	
Gate-to-Collector Charge	Q_{gc}		-	47.6	-	

SWITCHING CHARACTERISTICS, INDUCTIVE LOAD

Turn-On Delay Time	$t_{d(on)}$	$T_C = 25^{\circ}\text{C}$ $V_{CC} = 400\text{ V}, I_C = 75\text{ A}$ $R_g = 15\ \Omega$ $V_{GE} = 15\text{ V}$ Inductive Load, $T_C = 25^{\circ}\text{C}$	-	55	-	ns	
Rise Time	t_r		-	50	-		
Turn-Off Delay Time	$t_{d(off)}$		-	189	-		
Fall Time	t_f		-	39	-		
Turn-On Switching Loss	E_{on}	$V_{CC} = 400\text{ V}, I_C = 75\text{ A}$ $R_g = 15\ \Omega$ $V_{GE} = 15\text{ V}$ Inductive Load, $T_C = 175^{\circ}\text{C}$	-	1.06	-	mJ	
Turn-Off Switching Loss	E_{off}		-	1.56	-		
Total Switching Loss	E_{ts}		-	2.62	-		
Turn-On Delay Time	$t_{d(on)}$		$V_{CC} = 400\text{ V}, I_C = 75\text{ A}$ $R_g = 15\ \Omega$ $V_{GE} = 15\text{ V}$ Inductive Load, $T_C = 175^{\circ}\text{C}$	-	48	-	ns
Rise Time	t_r			-	56	-	
Turn-Off Delay Time	$t_{d(off)}$			-	205	-	
Fall Time	t_f			-	40	-	
Turn-On Switching Loss	E_{on}	-		2.34	-	mJ	
Turn-Off Switching Loss	E_{off}	-		1.81	-		
Total Switching Loss	E_{ts}	-	4.15	-			

DIODE CHARACTERISTICS

Forward voltage	V_F	$I_F = 75\text{ A}$ $I_F = 75\text{ A}, T_J = 175^{\circ}\text{C}$	-	1.8 1.7	2.1 -	V
-----------------	-------	---	---	------------	----------	---

FGH75T65SHDTLN4

Table 2. ELECTRICAL CHARACTERISTICS ($T_J = 25^\circ\text{C}$ unless otherwise noted)

Parameter	Symbol	Test Condition	Min	Typ	Max	Unit
DIODE CHARACTERISTICS						
Reverse Recovery Time	t_{rr}	$T_J = 25^\circ\text{C}$ $I_F = 75\text{ A}, di_F/dt = 200\text{ A}/\mu\text{s}$	-	36	-	ns
Reverse Recovery Charge	Q_{rr}		-	18	-	
Reverse Recovery Time	t_{rr}	$T_J = 175^\circ\text{C}$ $I_F = 75\text{ A}, di_F/dt = 200\text{ A}/\mu\text{s}$	-	270	-	ns
Reverse Recovery Charge	Q_{rr}		-	2199	-	μC
Reverse Recovery Energy	E_{rec}		-	160	-	μJ

Product parametric performance is indicated in the Electrical Characteristics for the listed test conditions, unless otherwise noted. Product performance may not be indicated by the Electrical Characteristics if operated under different conditions.

FGH75T65SHDTLN4

TYPICAL CHARACTERISTICS

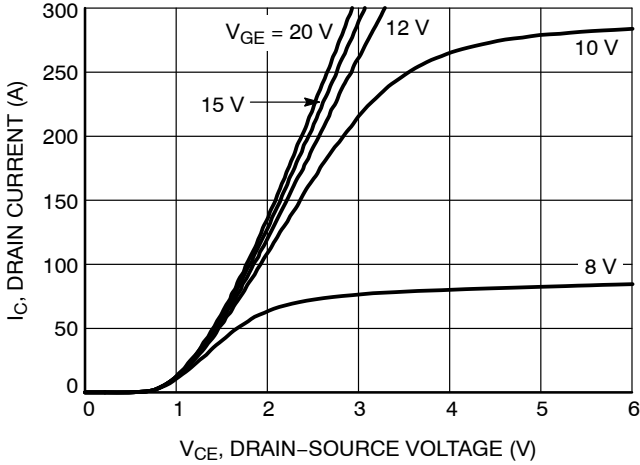

Figure 1. Typical Output Characteristics (25°C)

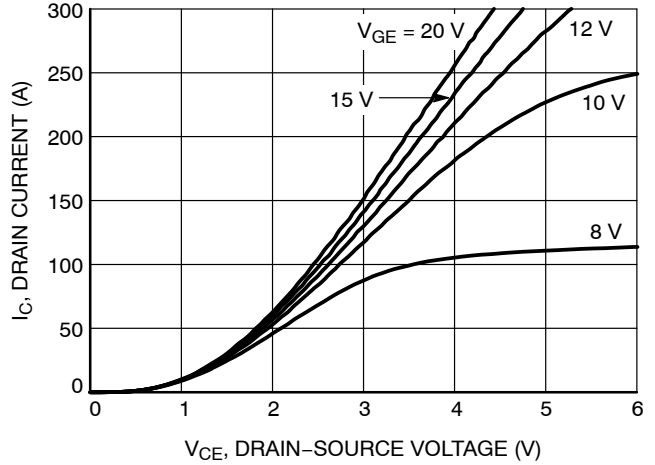

Figure 2. Typical Output Characteristics (175°C)

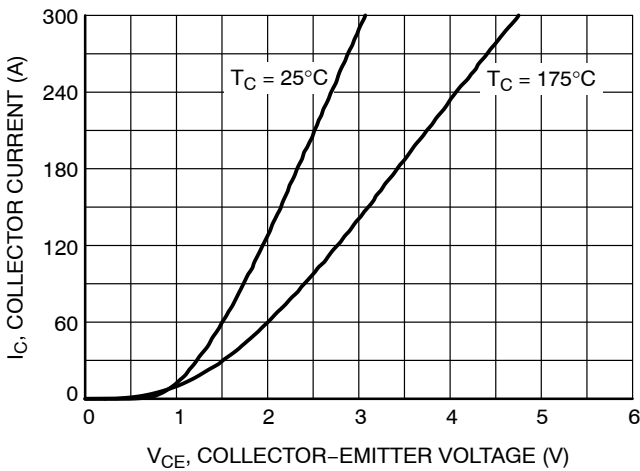

Figure 3. Typical Saturation Voltage Characteristics

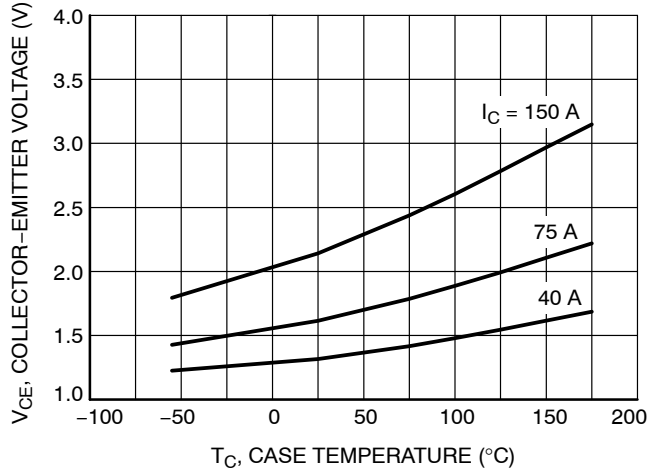

Figure 4. Saturation Voltage vs. Case Temperature at Variant Current Level

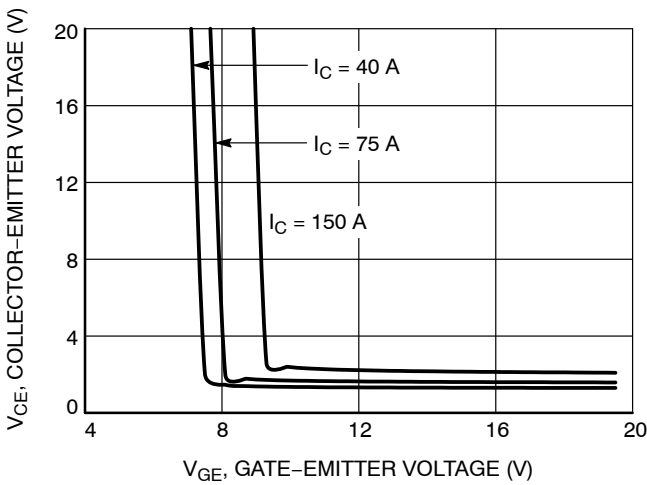

Figure 5. Saturation Voltage vs. V_{GE} (25°C)

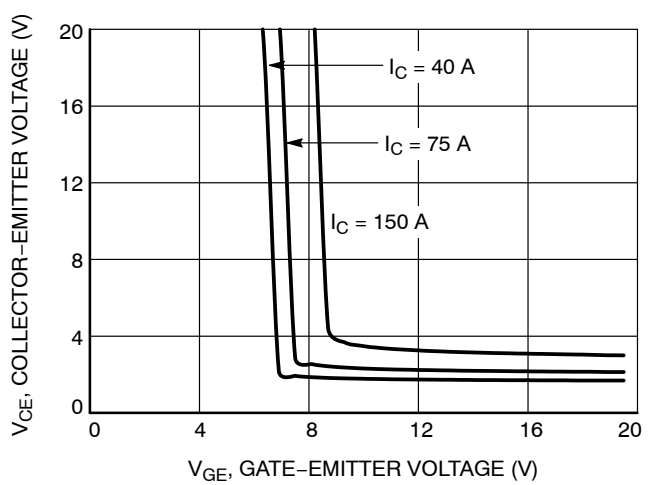

Figure 6. Saturation Voltage vs. V_{GE} (175°C)

FGH75T65SHDTLN4

TYPICAL CHARACTERISTICS

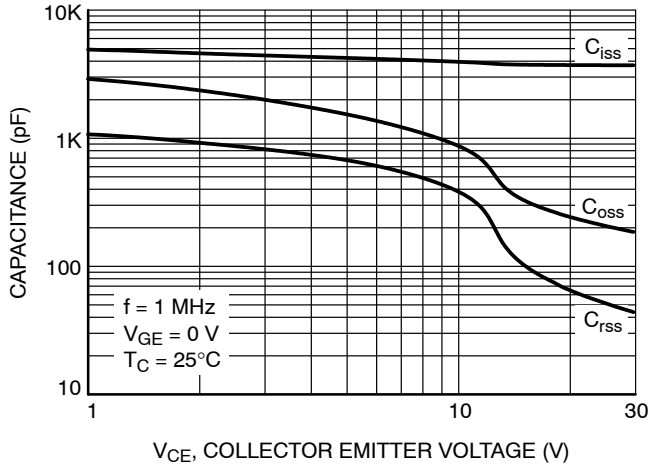

Figure 7. Capacitance Characteristics

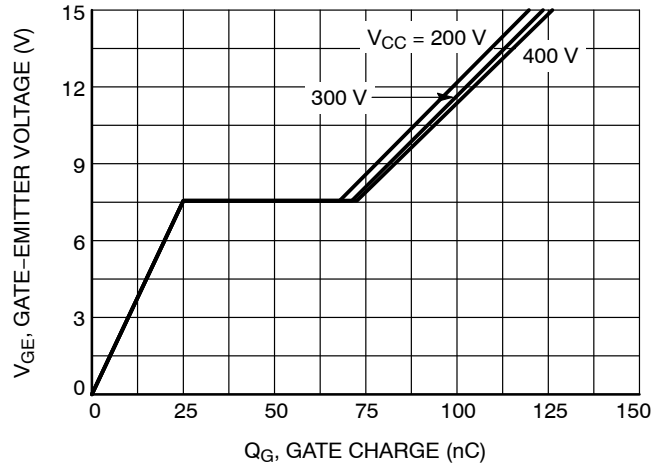

Figure 8. Gate Charge Characteristics

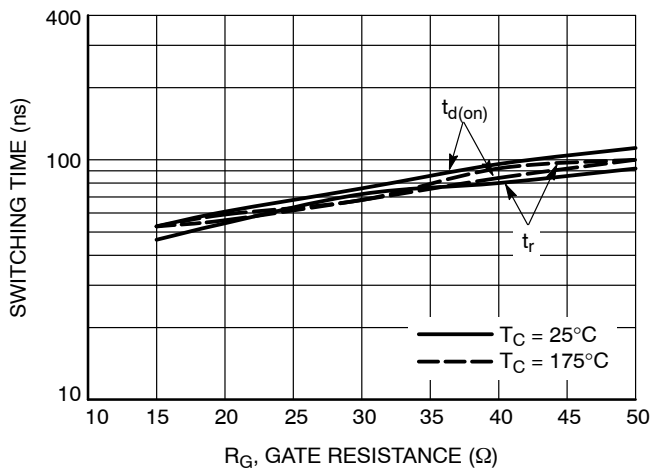

Figure 9. Turn-On Characteristics vs. Gate Resistance

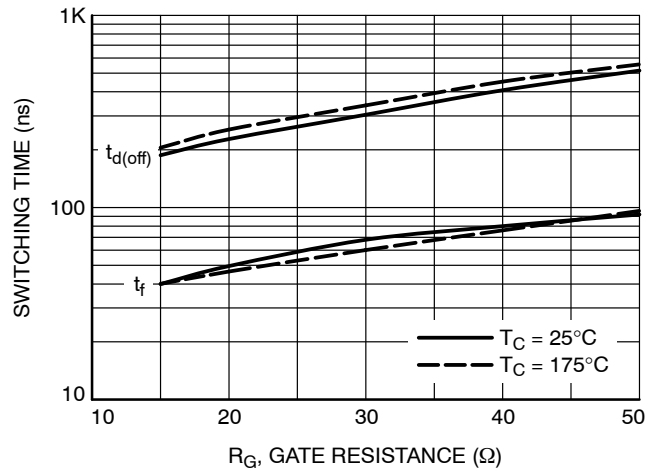

Figure 10. Turn-Off Characteristics vs. Gate Resistance

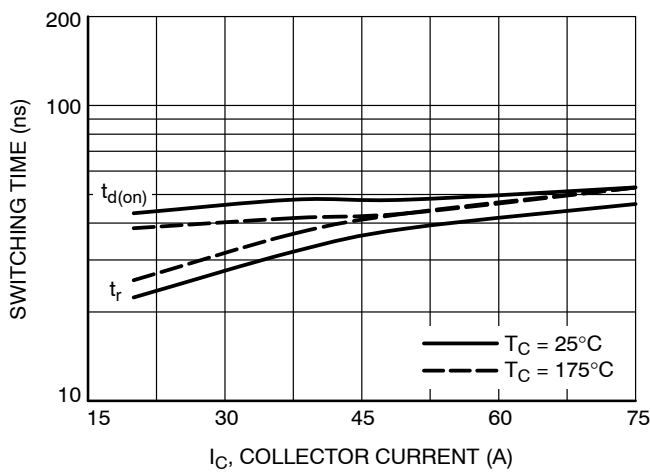

Figure 11. Turn-On Characteristics vs. Collector Current

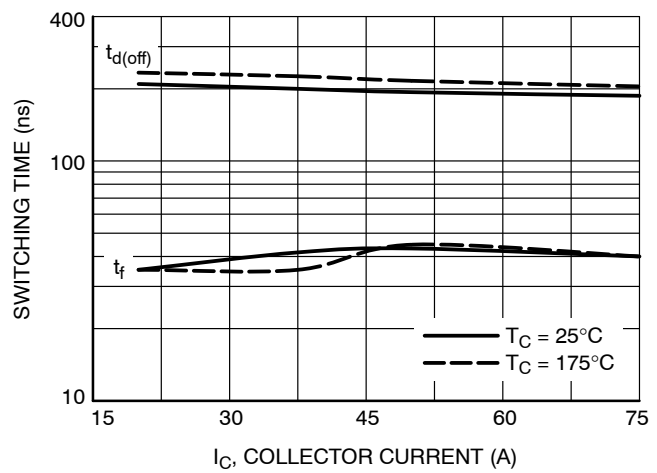

Figure 12. Turn-Off Characteristics vs. Collector Current

FGH75T65SHDTLN4

TYPICAL CHARACTERISTICS

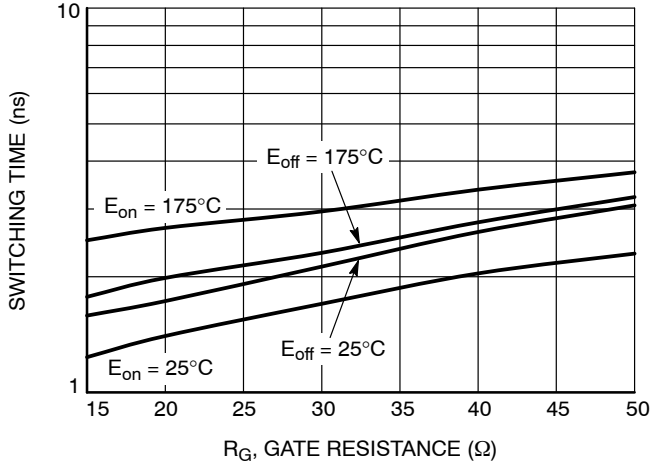

Figure 13. Switching Loss vs. Gate Resistance

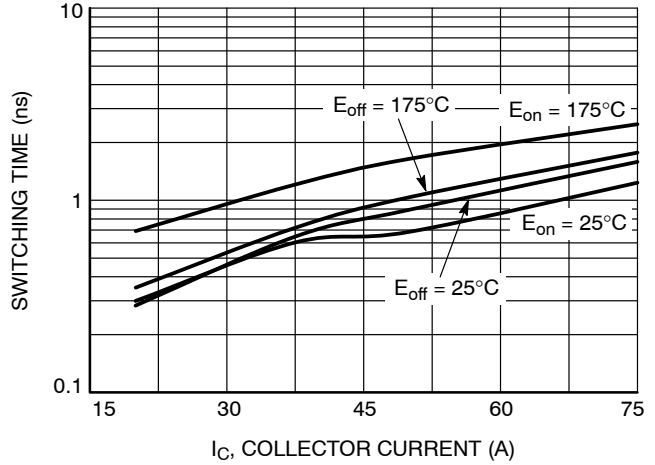

Figure 14. Switching Loss vs. Collector Current

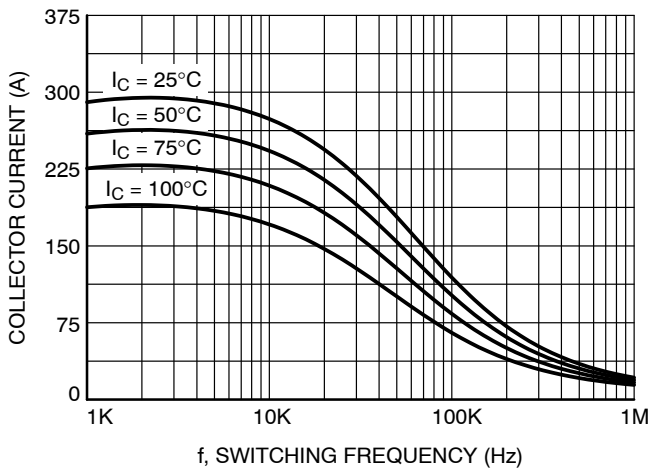

Figure 15. Load Frequency Template

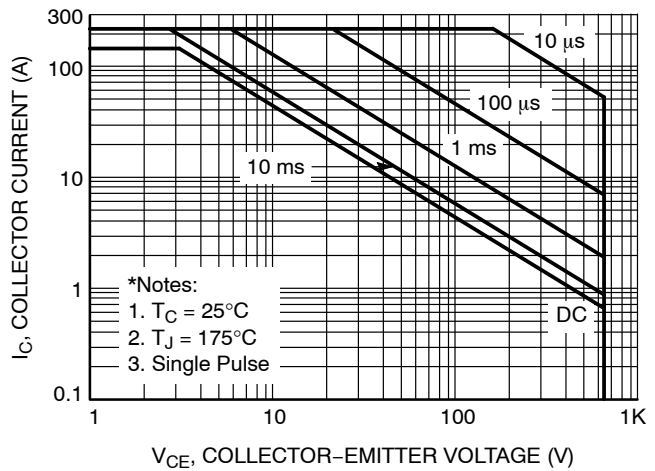

Figure 16. SOA Characteristics

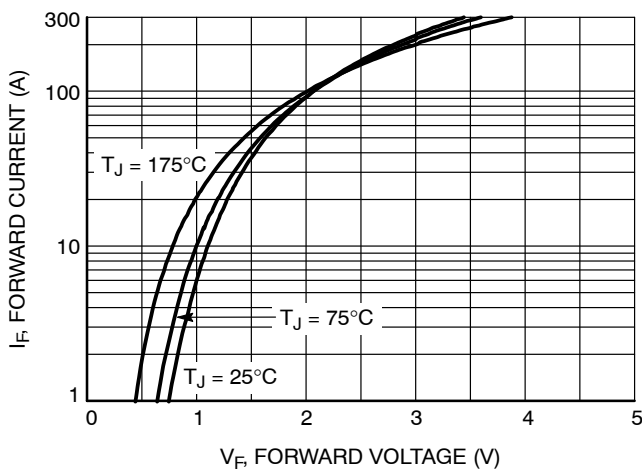

Figure 17. Forward Characteristics

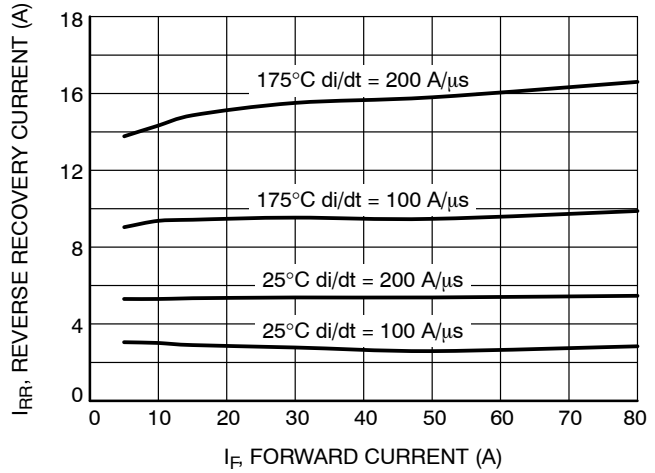

Figure 18. Reverse Recovery Current

FGH75T65SHDTLN4

TYPICAL CHARACTERISTICS

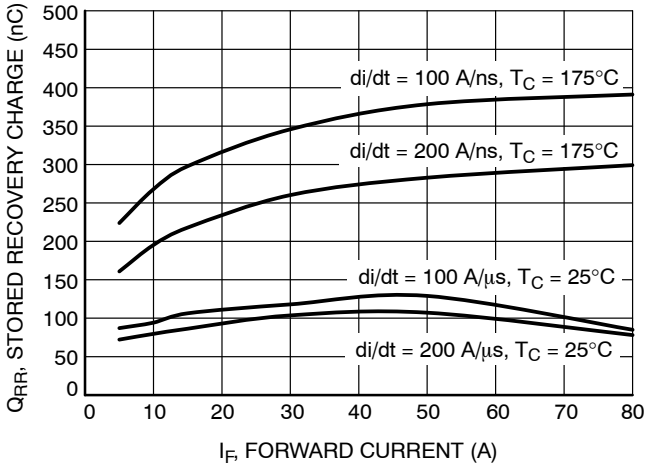

Figure 19. Reverse Recovery Time

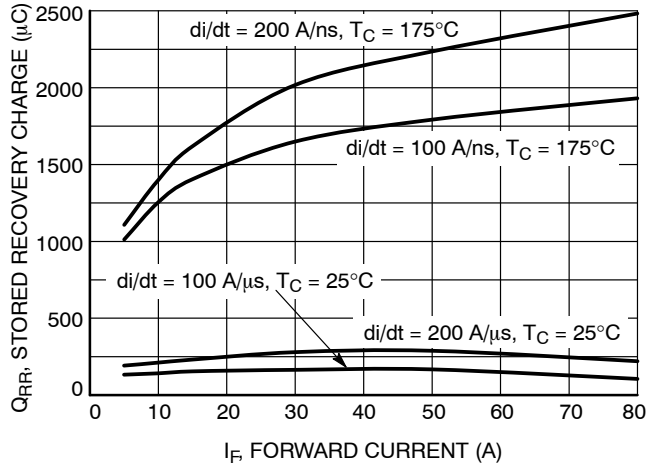

Figure 20. Stored Charge

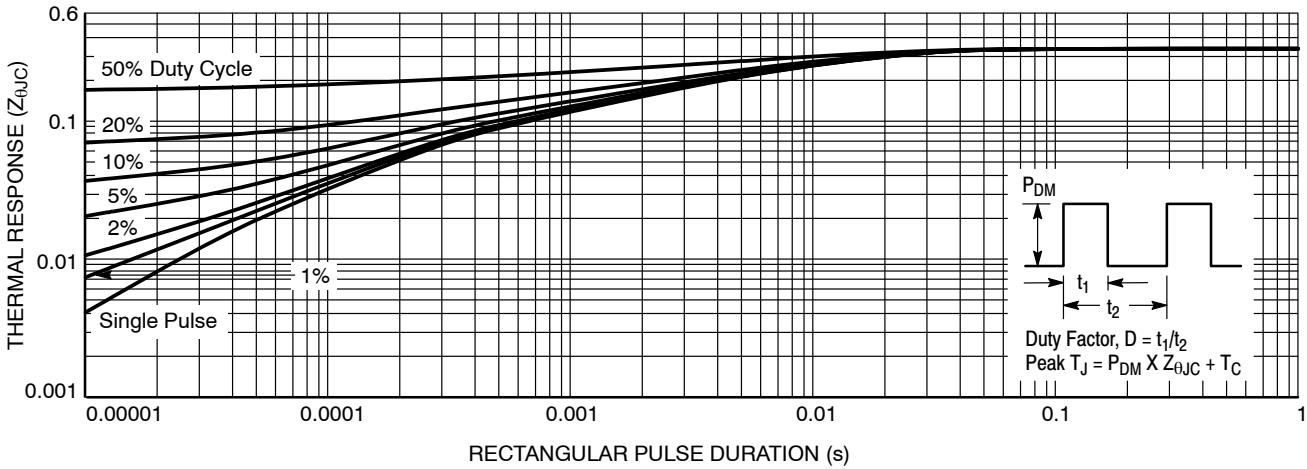

Figure 21. Transient Thermal Impedance of IGBT

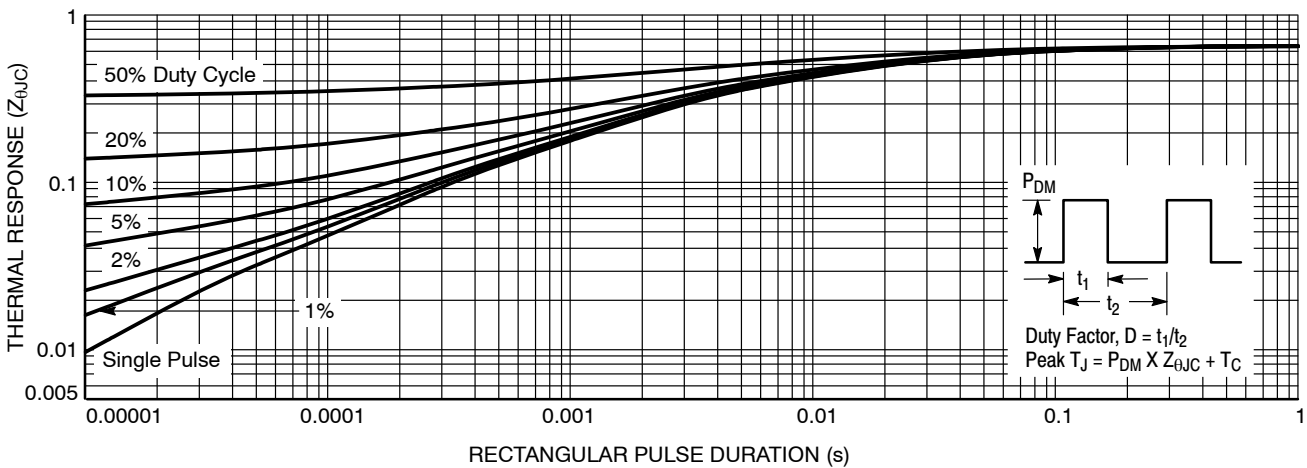
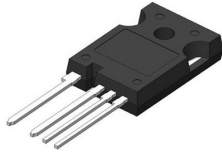

Figure 22. Transient Thermal Impedance of Diode

MECHANICAL CASE OUTLINE

PACKAGE DIMENSIONS

ON Semiconductor®



TO-247 4-LEAD, THIN LEADS CASE 340CW ISSUE A

DATE 16 SEP 2019

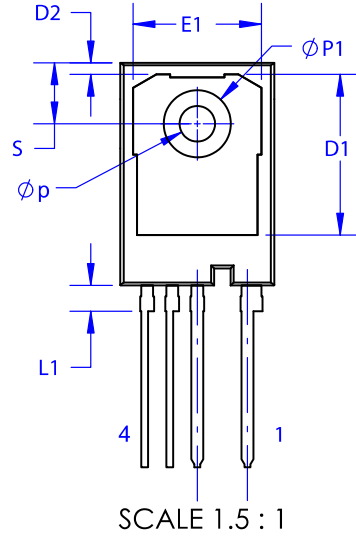
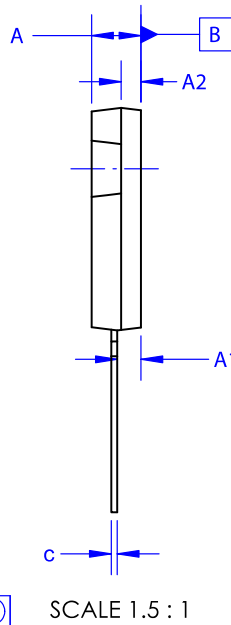
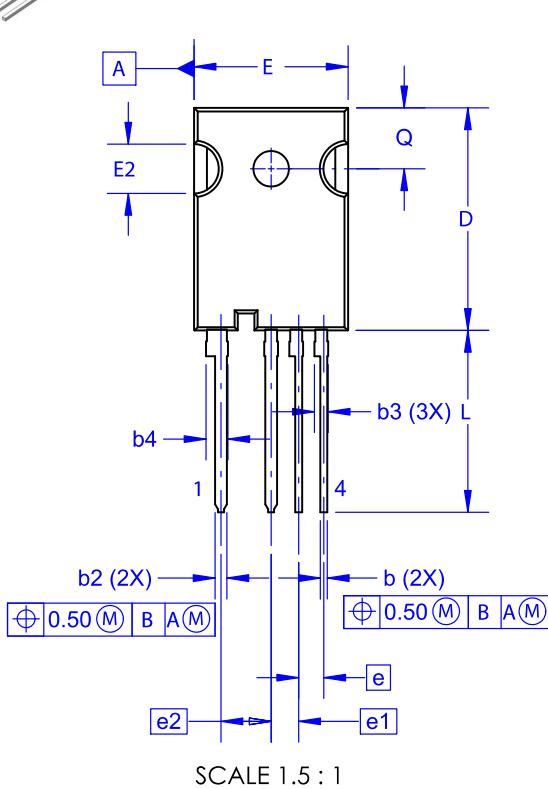

DIM	MILLIMETERS		
	MIN	NOM	MAX
A	4.80	5.00	5.20
A1	2.10	2.40	2.70
A2	1.80	2.00	2.20
b	0.57	0.70	0.83
b2	1.07	1.20	1.33
b3	1.20	1.40	1.60
b4	2.02	2.22	2.42
c	0.50	0.60	0.70
D	22.34	22.54	22.74
D1	16.00	16.30	16.50
D2	0.97	1.17	1.37
e		2.54	
e1		2.79	
e2		5.08	
E	15.40	15.60	15.80
E1	12.80	13.00	13.20
E2	4.80	5.00	5.20
L	18.12	18.42	18.72
L1	2.42	2.62	2.82
Øp	3.40	3.60	3.80
ØP1	6.60	6.80	7.00
Q	5.97	6.17	6.37
S	5.97	6.17	6.37

NOTES:

- A. NO INDUSTRY STANDARD APPLIES TO THIS PACKAGE.
- B. DIMENSIONS ARE EXCLUSIVE OF BURRS, MOLD FLASH AND TIE BAR EXTRUSIONS.
- C. ALL DIMENSIONS ARE IN MILLIMETERS.

DOCUMENT NUMBER:	98AON80893G	Electronic versions are uncontrolled except when accessed directly from the Document Repository. Printed versions are uncontrolled except when stamped "CONTROLLED COPY" in red.
DESCRIPTION:	TO-247 4-LEAD, THIN LEADS	PAGE 1 OF 1

ON Semiconductor and are trademarks of Semiconductor Components Industries, LLC dba ON Semiconductor or its subsidiaries in the United States and/or other countries. ON Semiconductor reserves the right to make changes without further notice to any products herein. ON Semiconductor makes no warranty, representation or guarantee regarding the suitability of its products for any particular purpose, nor does ON Semiconductor assume any liability arising out of the application or use of any product or circuit, and specifically disclaims any and all liability, including without limitation special, consequential or incidental damages. ON Semiconductor does not convey any license under its patent rights nor the rights of others.

onsemi, **Onsemi**, and other names, marks, and brands are registered and/or common law trademarks of Semiconductor Components Industries, LLC dba "**onsemi**" or its affiliates and/or subsidiaries in the United States and/or other countries. **onsemi** owns the rights to a number of patents, trademarks, copyrights, trade secrets, and other intellectual property. A listing of **onsemi**'s product/patent coverage may be accessed at www.onsemi.com/site/pdf/Patent-Marking.pdf. **onsemi** reserves the right to make changes at any time to any products or information herein, without notice. The information herein is provided "as-is" and **onsemi** makes no warranty, representation or guarantee regarding the accuracy of the information, product features, availability, functionality, or suitability of its products for any particular purpose, nor does **onsemi** assume any liability arising out of the application or use of any product or circuit, and specifically disclaims any and all liability, including without limitation special, consequential or incidental damages. Buyer is responsible for its products and applications using **onsemi** products, including compliance with all laws, regulations and safety requirements or standards, regardless of any support or applications information provided by **onsemi**. "Typical" parameters which may be provided in **onsemi** data sheets and/or specifications can and do vary in different applications and actual performance may vary over time. All operating parameters, including "Typicals" must be validated for each customer application by customer's technical experts. **onsemi** does not convey any license under any of its intellectual property rights nor the rights of others. **onsemi** products are not designed, intended, or authorized for use as a critical component in life support systems or any FDA Class 3 medical devices or medical devices with a same or similar classification in a foreign jurisdiction or any devices intended for implantation in the human body. Should Buyer purchase or use **onsemi** products for any such unintended or unauthorized application, Buyer shall indemnify and hold **onsemi** and its officers, employees, subsidiaries, affiliates, and distributors harmless against all claims, costs, damages, and expenses, and reasonable attorney fees arising out of, directly or indirectly, any claim of personal injury or death associated with such unintended or unauthorized use, even if such claim alleges that **onsemi** was negligent regarding the design or manufacture of the part. **onsemi** is an Equal Opportunity/Affirmative Action Employer. This literature is subject to all applicable copyright laws and is not for resale in any manner.

PUBLICATION ORDERING INFORMATION

LITERATURE FULFILLMENT:

Email Requests to: orderlit@onsemi.com

onsemi Website: www.onsemi.com

TECHNICAL SUPPORT

North American Technical Support:

Voice Mail: 1 800-282-9855 Toll Free USA/Canada

Phone: 011 421 33 790 2910

Europe, Middle East and Africa Technical Support:

Phone: 00421 33 790 2910

For additional information, please contact your local Sales Representative