



The Future of Analog IC Technology®

MPQ8633B

16V, 20A, Synchronous, Step-Down Converter with Adjustable Current Limit, Programmable Frequency, and Voltage Tracking

DESCRIPTION

The MPQ8633B is a fully integrated, high-frequency, synchronous, buck converter. It offers a very compact solution that achieves up to 20A of output current with excellent load and line regulation over a wide input supply range. The MPQ8633B operates at high efficiency over a wide output current load range.

The MPQ8633B adopts an internally compensated constant-on-time (COT) control mode that provides fast transient response and eases loop stabilization.

The operating frequency can be set to 600kHz, 800kHz, or 1000kHz easily with MODE configuration, allowing the MPQ8633B frequency to remain constant regardless of the input and output voltages.

The output voltage start-up ramp is controlled by an internal 1ms timer. It can be increased by adding a capacitor on TRK/REF. An open-drain power good (PGOOD) signal indicates if the output is within its nominal voltage range. PGOOD is clamped at around 0.7V with an external pull-up voltage when the input supply fails to power the MPQ8633B.

Full protection features include over-current protection (OCP), over-voltage protection (OVP), under-voltage protection (UVP), and over-temperature protection (OTP).

The MPQ8633B requires a minimal number of readily available, standard, external components and is available in a QFN-21 (3mmx4mm) package.

FEATURES

- Wide Input Voltage Range
 - 2.7V to 16V with External 3.3V VCC Bias
 - 4V to 16V with Internal Bias or External 3.3V VCC Bias
- Differential Output Voltage Remote Sense
- Programmable Accurate Current Limit Level
- 20A Output Current
- Low $R_{DS(ON)}$ Integrated Power MOSFETs

- Proprietary Switching Loss Reduction Technique
- Adaptive COT for Ultrafast Transient Response
- Stable with Zero ESR Output Capacitor
- 0.5% Reference Voltage over 0°C to +70°C Junction Temperature Range
- 1% Reference Voltage from -40°C to +125°C Junction Temperature Range
- Selectable Pulse Skip or Forced CCM Operation
- Excellent Load Regulation
- Output Voltage Tracking
- Output Voltage Discharge
- PGOOD Active Clamped at Low Level during Power Failure
- Programmable Soft-Start Time from 1ms
- Pre-Bias Start-Up
- Selectable Switching Frequency from 600kHz, 800kHz, and 1000kHz
- Non-Latch OCP, UVP, UVLO, Thermal Shutdown, and Latch-Off for OVP
- Output Adjustable from 0.6V to 90%*VIN, up to 5.5V Max
- Available in a QFN-21 (3mmx4mm) Package

APPLICATIONS

- Telecom and Networking Systems
- Servers, Cloud-Computing, Storage
- Base Stations
- General Purpose Point-of-Load (PoL)
- 12V Distribution Power Systems
- High-end TV
- Game Consoles and Graphic Cards

All MPS parts are lead-free, halogen-free, and adhere to the RoHS directive. For MPS green status, please visit the MPS website under Quality Assurance. "MPS" and "The Future of Analog IC Technology" are registered trademarks of Monolithic Power Systems, Inc.

TYPICAL APPLICATION

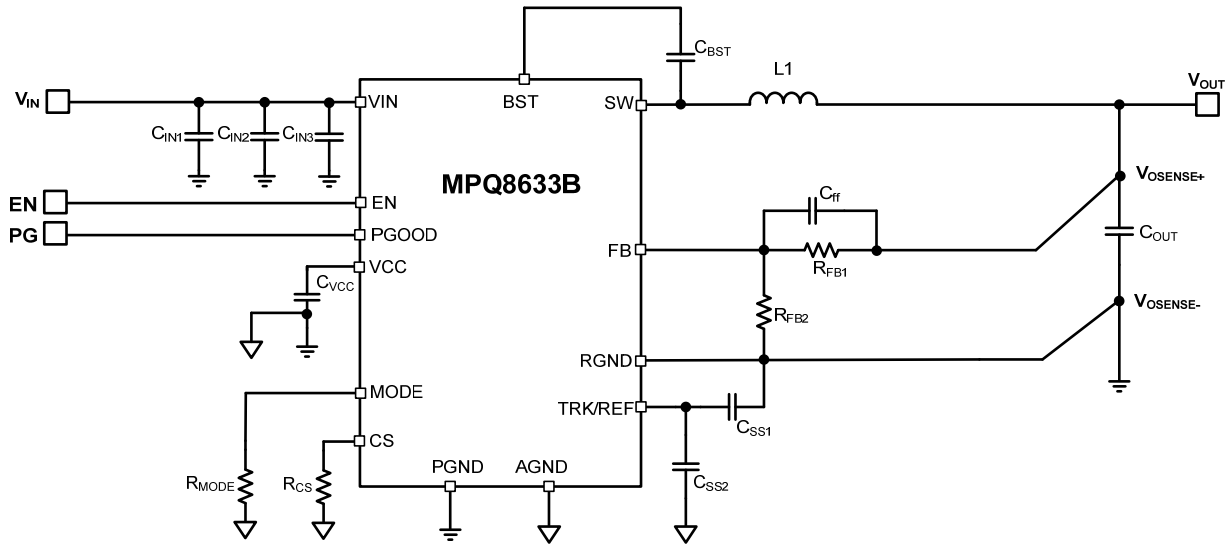



MPQ8633B – 16V, 20A, SYNCHRONOUS, STEP-DOWN CONVERTER W/ ADJUSTABLE CURRENT LIMIT, PROGRAMMABLE FREQUENCY, AND VOLTAGE TRACKING

ORDERING INFORMATION

Part Number	Package	Top Marking
MPQ8633BGLE*	QFN-21 (3mmx4mm)	See Below

* For Tape & Reel, add suffix -Z (e.g. MPQ8633BGLE-Z)

TOP MARKING

MPYW
8633
BLLL
E

MP: MPS prefix
Y: Year code
W: Week code
8633B: First five digits of the part number
LLL: Lot number
E: MPQ8633BGLE

PACKAGE REFERENCE

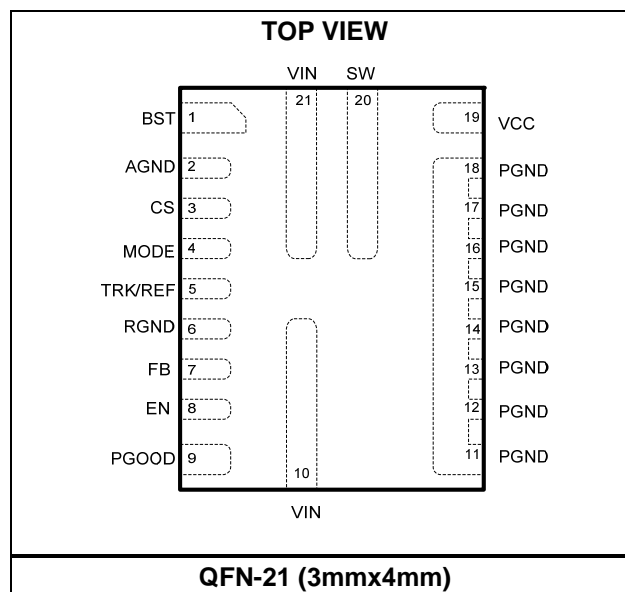



Absolute Maximum Ratings ⁽¹⁾

Supply voltage (V_{IN})	18V
$V_{SW(DC)}$	-0.3V to V_{IN}
V_{SW} (25ns) ⁽²⁾	-3V to 25V
V_{SW} (25ns)	-5V to 25V
V_{BST}	$V_{SW} + 4V$
$V_{CC, EN}$	4.5V
All other pins	-0.3V to 4.3V
Junction temperature	170°C
Lead temperature	260°C
Storage temperature	-65°C to +170°C

Recommended Operating Conditions ⁽³⁾

Supply voltage (V_{IN})	4V to 16V
$V_{IN(DC)} - V_{SW(DC)}$ ⁽⁴⁾	-0.3V to $V_{IN} + 0.3V$
$V_{SW(DC)}$ ⁽⁴⁾	-0.3V to $V_{IN} + 0.3V$
Output voltage (V_{OUT})	0.6V to 5.5V
External VCC bias (V_{CC_EXT})	3.12V to 3.6V
Maximum output current (I_{OUT_MAX})	20A
Maximum output current limit (I_{OC_MAX})	24A
Maximum peak inductor current (I_{L_PEAK})	28A
EN voltage (V_{EN})	3.6V
Operating junction temp. (T_J)	-40°C to +125°C

Thermal Resistance ⁽⁵⁾	θ_{JB}	θ_{JC_TOP}	
QFN-21 (3mmx4mm)	8	18	°C/W

NOTES:

- 1) Exceeding these ratings may damage the device.
- 2) Measured using a differential oscilloscope probe.
- 3) The device is not guaranteed to function outside of its operating conditions.
- 4) The voltage rating can be in the range of -3V to 23V for a period of 25ns or less with a maximum repetition rate of 1000kHz when the input voltage is 16V.
- 5) θ_{JB} is the thermal resistance from the junction to the board around the PGND soldering point.
 θ_{JC_TOP} is the thermal resistance from the junction to the top of the package.



ELECTRICAL CHARACTERISTICS

$V_{IN} = 12V$, $T_J = -40^{\circ}C$ to $+125^{\circ}C$, unless otherwise noted.

Parameters	Symbol	Condition	Min	Typ	Max	Units
Supply Current						
Supply current (shutdown)	I_{IN}	$V_{EN} = 0V$		0	10	μA
Supply current (quiescent)	I_{IN}	$V_{EN} = 2V$, $V_{FB} = 0.62V$		650	850	μA
MOSFET						
Switch leakage	SW_{LKG_HS}	$V_{EN} = 0V$, $V_{SW} = 0V$		0	10	μA
	SW_{LKG_LS}	$V_{EN} = 0V$, $V_{SW} = 12V$		0	30	
HS on-state resistance	$R_{DS_ON_HS}$	$V_{EN} = 2V @ 25^{\circ}C$		8.6		$m\Omega$
LS on-state resistance	$R_{DS_ON_LS}$	$V_{EN} = 2V @ 25^{\circ}C$		2.5		$m\Omega$
Current Limit						
Current limit threshold	V_{LIM}		1.15	1.2	1.25	V
I_{CS} to I_{OUT} ratio	I_{CS}/I_{OUT}	$I_{OUT} \geq 2A$	9	10	11	$\mu A/A$
Low-side negative current limit	I_{LIM_NEG}			-10		A
Negative current limit time out ⁽⁶⁾	t_{NCL_Timer}			200		ns
Switching Frequency						
Switching frequency ⁽⁷⁾	f_{SW}	MODE = GND, $I_{OUT} = 0A$, $V_{OUT} = 1V$	480	600	720	kHz
		MODE = 30.1k Ω , $I_{OUT} = 0A$, $V_{OUT} = 1V$	680	800	920	kHz
		MODE = 60.4 k Ω , $I_{OUT} = 0A$, $V_{OUT} = 1V$	850	1000	1150	kHz
Minimum on time ⁽⁶⁾	T_{ON_MIN}	$V_{FB} = 500mV$			50	ns
Minimum off time ⁽⁶⁾	T_{OFF_MIN}	$V_{FB} = 500mV$			180	ns
Over-Voltage and Under-Voltage Protection						
OVP threshold	V_{OVP}		113%	116%	119%	V_{REF}
UVP threshold	V_{UVP}		77%	80%	83%	V_{REF}
Feedback Voltage and Soft Start						
Feedback voltage	V_{REF}	$T_J = -40^{\circ}C$ to $+125^{\circ}C$	594	600	606	mV
		$T_J = 0^{\circ}C$ to $+70^{\circ}C$	597	600	603	mV
TRK/REF sourcing current	I_{TRACK_Source}	$V_{TRK/REF} = 0V$		42		μA
TRK/REF sinking current	I_{TRACK_Sink}	$V_{TRK/REF} = 1V$		12		μA
Soft-start time	t_{SS}	$C_{TRACK} = 1nF$, $T_J = +25^{\circ}C$	0.75	1	1.25	ms
Error Amplifier						
Error amplifier offset	V_{OS}		-3	0	3	mV
Feedback current	I_{FB}	$V_{FB} = REF$		50	100	nA



ELECTRICAL CHARACTERISTICS (continued)

V_{IN} = 12V, T_J = -40°C to +125°C, unless otherwise noted.

Parameters	Symbol	Condition	Min	Typ	Max	Units
Enable and UVLO						
Enable input rising threshold	V _{IEN}		1.17	1.22	1.27	V
Enable hysteresis	V _{EN-HYS}			200		mV
Enable input current	I _{EN}	V _{EN} = 2V		0		μA
Soft shutdown discharge FET	R _{ON_DISCH}			80	150	Ω
VIN UVLO						
VIN under-voltage lockout threshold rising	V _{INvth_Rise}	V _{CC} = 3.3V	2.1	2.4	2.7	V
VIN under-voltage lockout threshold falling	V _{INvth_Fall}		1.55	1.85	2.15	
VCC Regulator						
VCC under-voltage lockout threshold rising	V _{CCvth_Rise}		2.65	2.8	2.95	V
VCC under-voltage lockout threshold falling	V _{CCvth_Fall}		2.35	2.5	2.65	V
VCC regulator	V _{CC}		2.88	3.00	3.12	V
VCC load regulation		I _{CC} = 25mA		0.5		%
Power Good						
Power good high threshold	P _{Gvth_Hi_Rise}	FB from low to high	89.5%	92.5%	95.5%	V _{REF}
Power good low threshold	P _{Gvth_Lo_Rise}	FB from low to high	113%	116%	119%	V _{REF}
	P _{Gvth_Lo_Fall}	FB from high to low	77%	80%	83%	V _{REF}
Power good low to high delay	P _{GTd}	T _J = 25°C	0.63	0.9	1.17	ms
Power good sink current capability	V _{PG}	I _{PG} = 10mA			0.5	V
Power good leakage current	I _{PG_LEAK}	V _{PG} = 3.3V			3	μA
Power good low-level output voltage	V _{OL_100}	V _{IN} = 0V, pull PGOOD up to 3.3V through a 100kΩ resistor @ 25°C		650	800	mV
	V _{OL_10}	V _{IN} = 0V, pull PGOOD up to 3.3V through a 10kΩ resistor @ 25°C		750	900	mV
Thermal Protection						
Thermal shutdown ⁽⁶⁾	T _{SD}			160		°C
Thermal shutdown hysteresis ⁽⁶⁾				30		°C

NOTE:

6) Guaranteed by design.

7) Guaranteed by design over temperature.



TYPICAL PERFORMANCE CHARACTERISTICS

$V_{IN} = 12V$, $T_A = 25^{\circ}C$, $V_{OUT} = 1V$, $F_S = 800kHz$ unless otherwise noted.

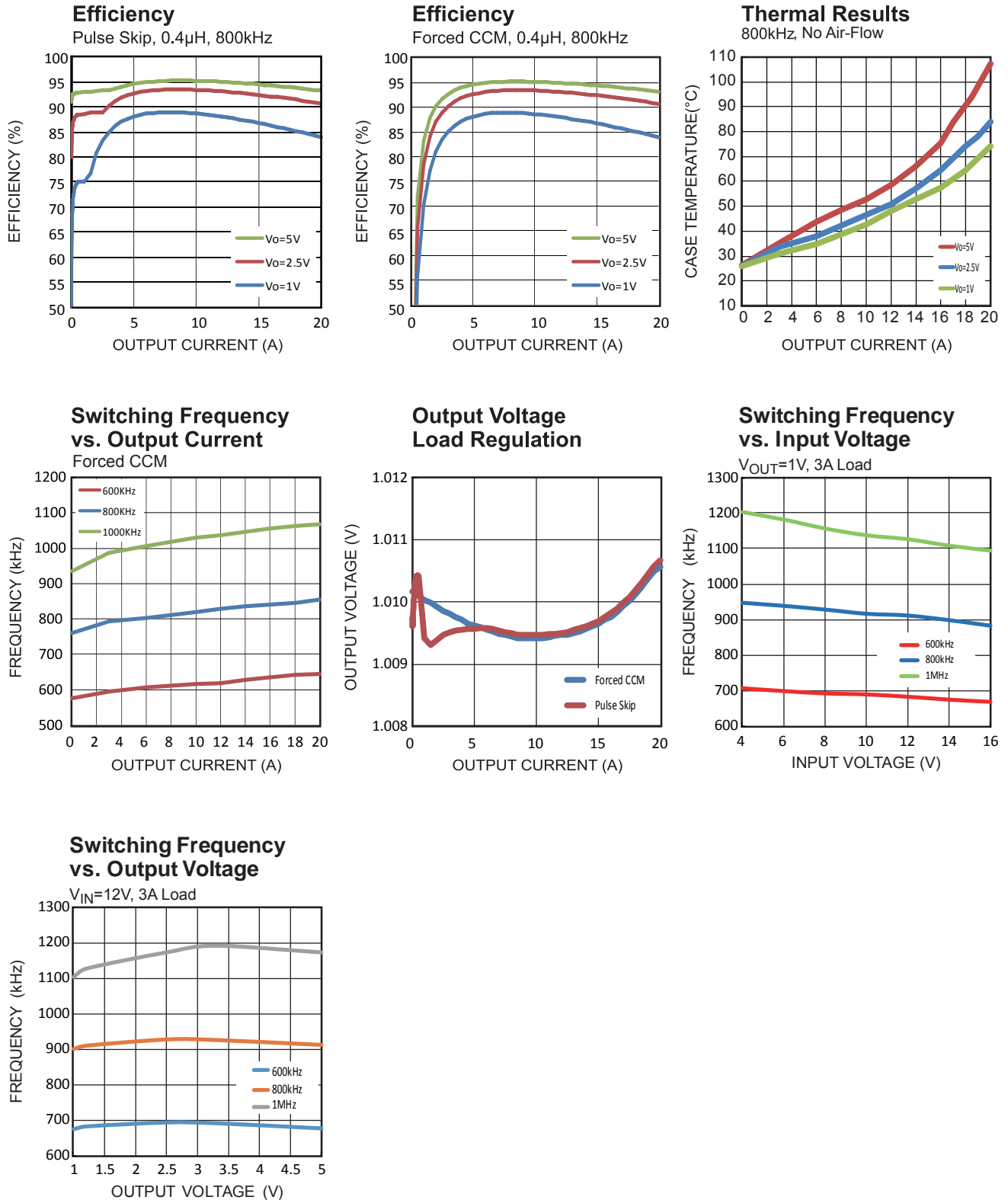

TYPICAL PERFORMANCE CHARACTERISTICS (continued)

$V_{IN} = 12V$, $T_A = 25^\circ C$, $V_{OUT} = 1V$, $F_S = 800kHz$ unless otherwise noted.

Steady State

$I_{OUT} = 0A$, Pulse Skip

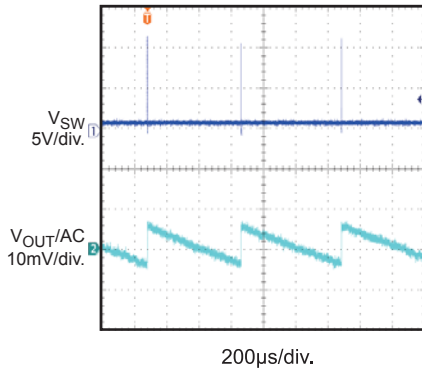

Steady State

$I_{OUT} = 0.5A$, Pulse Skip

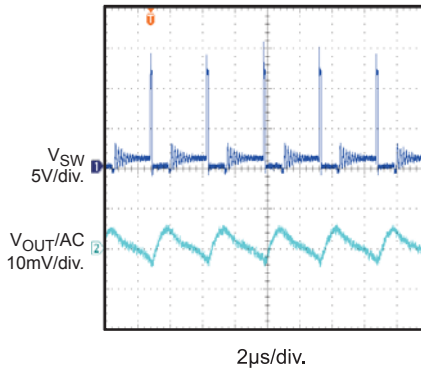

Steady State

$I_{OUT} = 20A$, Pulse Skip

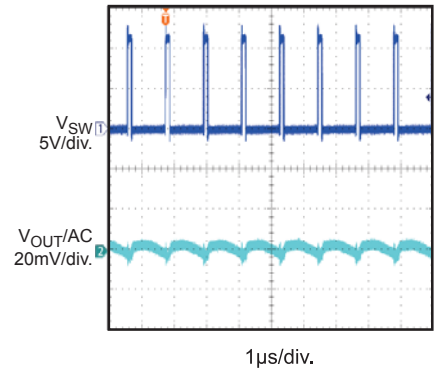

Steady State

$I_{OUT} = 0A$, Forced CCM

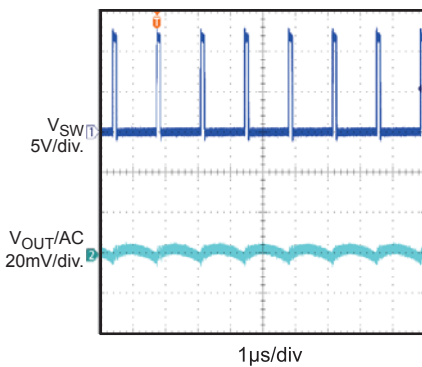

Steady State

$I_{OUT} = 20A$, Forced CCM

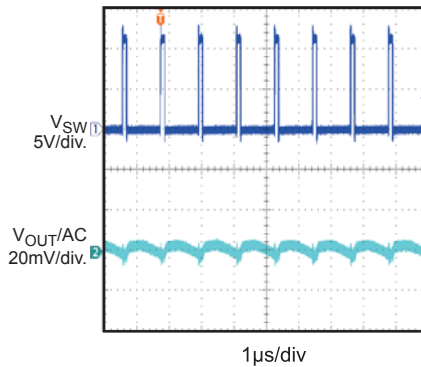

Load Transient

$I_{OUT} = 0A \sim 8A$, Pulse Skip

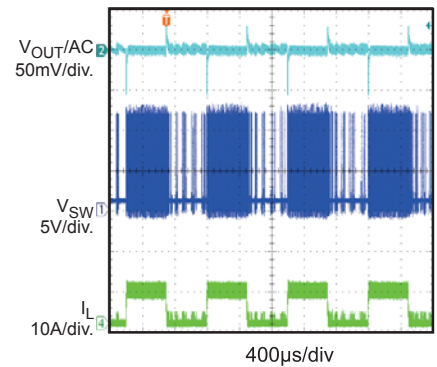

Load Transient

$I_{OUT} = 0A \sim 8A$, Forced CCM

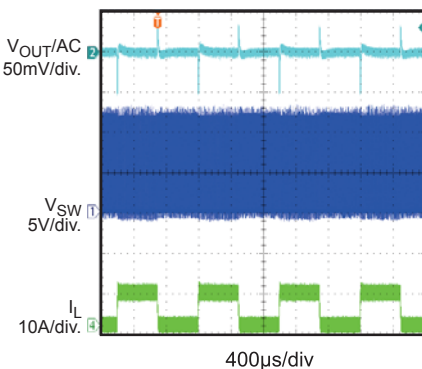

Power Up through EN

$I_{OUT} = 0A$, Pulse Skip

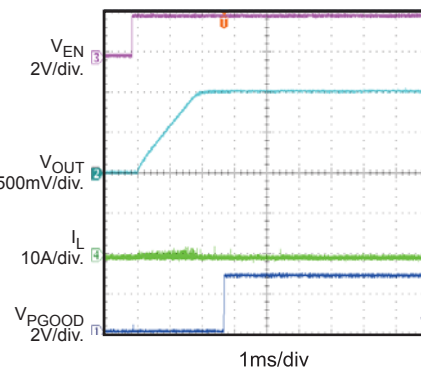

Power Up through EN

$I_{OUT} = 20A$, Pulse Skip

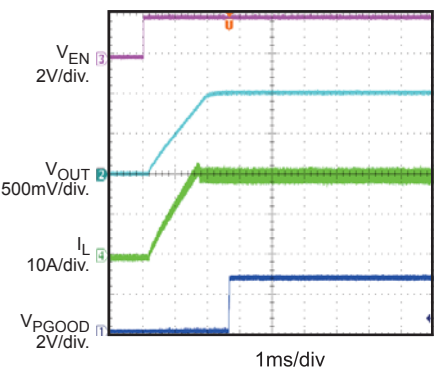

TYPICAL PERFORMANCE CHARACTERISTICS (continued)

$V_{IN} = 12V$, $T_A = 25^{\circ}C$, $V_{OUT} = 1V$, $F_S = 800kHz$ unless otherwise noted.

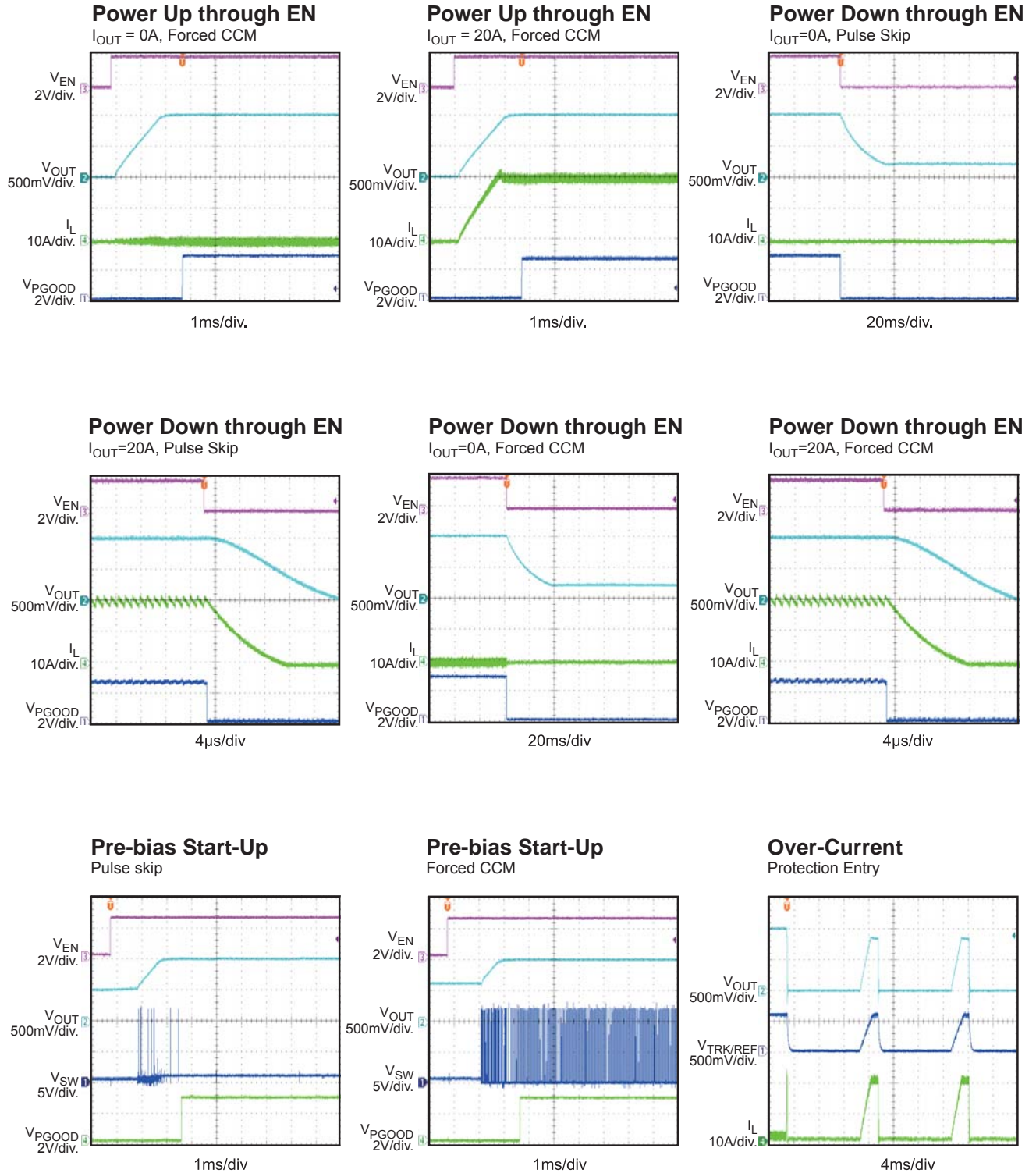

TYPICAL PERFORMANCE CHARACTERISTICS (continued)

$V_{IN} = 12V$, $T_A = 25^{\circ}C$, $V_{OUT} = 1V$, $F_S = 800kHz$ unless otherwise noted.

Over-Current Protection Recovery

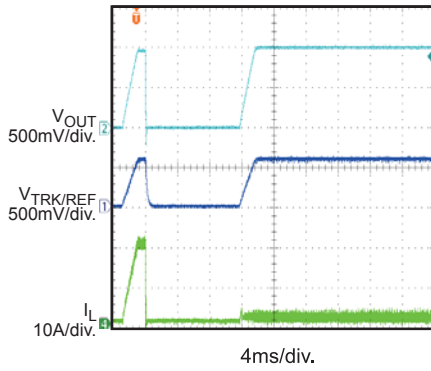

OSM Operation Pulse Skip Mode

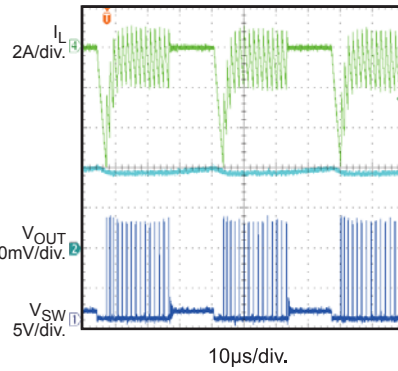

Over-Voltage Protection Pulse Skip Mode

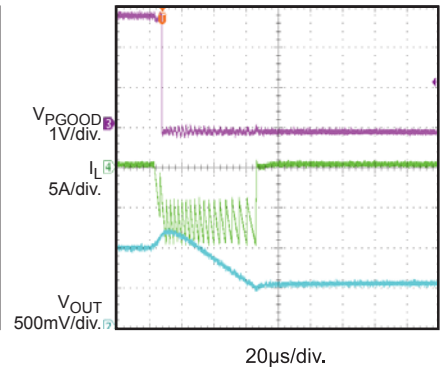

Over-Voltage Protection Forced CCM

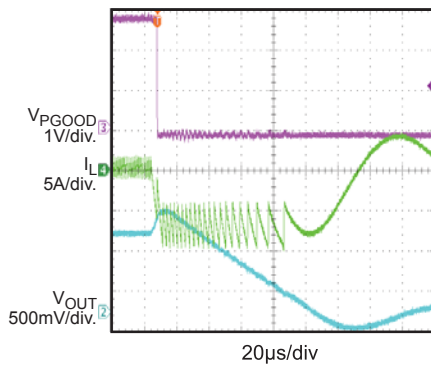



PIN FUNCTIONS

QFN-21 PIN #	Name	Description
1	BST	Bootstrap. Connect a capacitor between SW and BS to form a floating supply across the high-side switch driver.
2	AGND	Analog ground. Select AGND as the control circuit reference point.
3	CS	Current limit. Connect a resistor to AGND to set the current limit trip point. See equation 4 for additional details.
4	MODE	Operation mode selection. Program MODE to select CCM, pulse skip mode, and the operating switching frequency. See Table 1 for additional details.
5	TRK/REF	External tracking voltage input. The output voltage tracks this input signal. Decouple TRK/REF with a ceramic capacitor placed as close to it as possible. X7R or X5R grade dielectric ceramic capacitors are recommended for their stable temperature characteristics. The capacitance of this capacitor determines the soft-start time. See Equation 2 and 3 for additional details.
6	RGND	Differential remote sense negative input. Connect RGND to the negative side of the voltage sense point directly. Short RGND to GND if the remote sense is not used.
7	FB	Feedback (differential remote sense positive input). An external resistor divider from the output to RGND tapped to FB sets the output voltage. It is recommended to place the resistor divider as close to FB as possible. Vias should be avoided on the FB traces.
8	EN	Enable. EN is an input signal that turns the regulator on or off. Drive EN high to turn on the regulator; drive EN low to turn off the regulator. Connect EN to VIN through a pull-up resistor or a resistive voltage divider for automatic start-up. Do not float EN.
9	PGOOD	Power good output. PGOOD is an open-drain signal. A pull-up resistor connected to a DC voltage is required to indicate a logic high signal if the output voltage is within regulation. There is a delay of about 1ms between the time $FB \geq 92.5\%$ and PGOOD pulling high.
10, 21	VIN	Input voltage. VIN supplies power for the internal MOSFET and regulator. Input capacitors are needed to decouple the input rail. Use wide PCB traces to make the connection.
11-18	PGND	System ground. PGND is the reference ground of the regulated output voltage. Therefore, care must be taken during PCB layout. Use wide PCB traces to make the connection.
19	VCC	Internal 3V LDO output. The driver and control circuits are powered from the VCC voltage. Decouple VCC with a ceramic capacitor at least 1 μ F placed as close to it as possible. X7R or X5R grade dielectric ceramic capacitors are recommended for their stable temperature characteristics.
20	SW	Switch output. Connect SW to the inductor and bootstrap capacitor. SW is driven up to VIN by the high-side switch during the on-time of the PWM duty cycle. The inductor current drives SW low during the off-time. Use wide PCB traces to make the connection.

BLOCK DIAGRAM

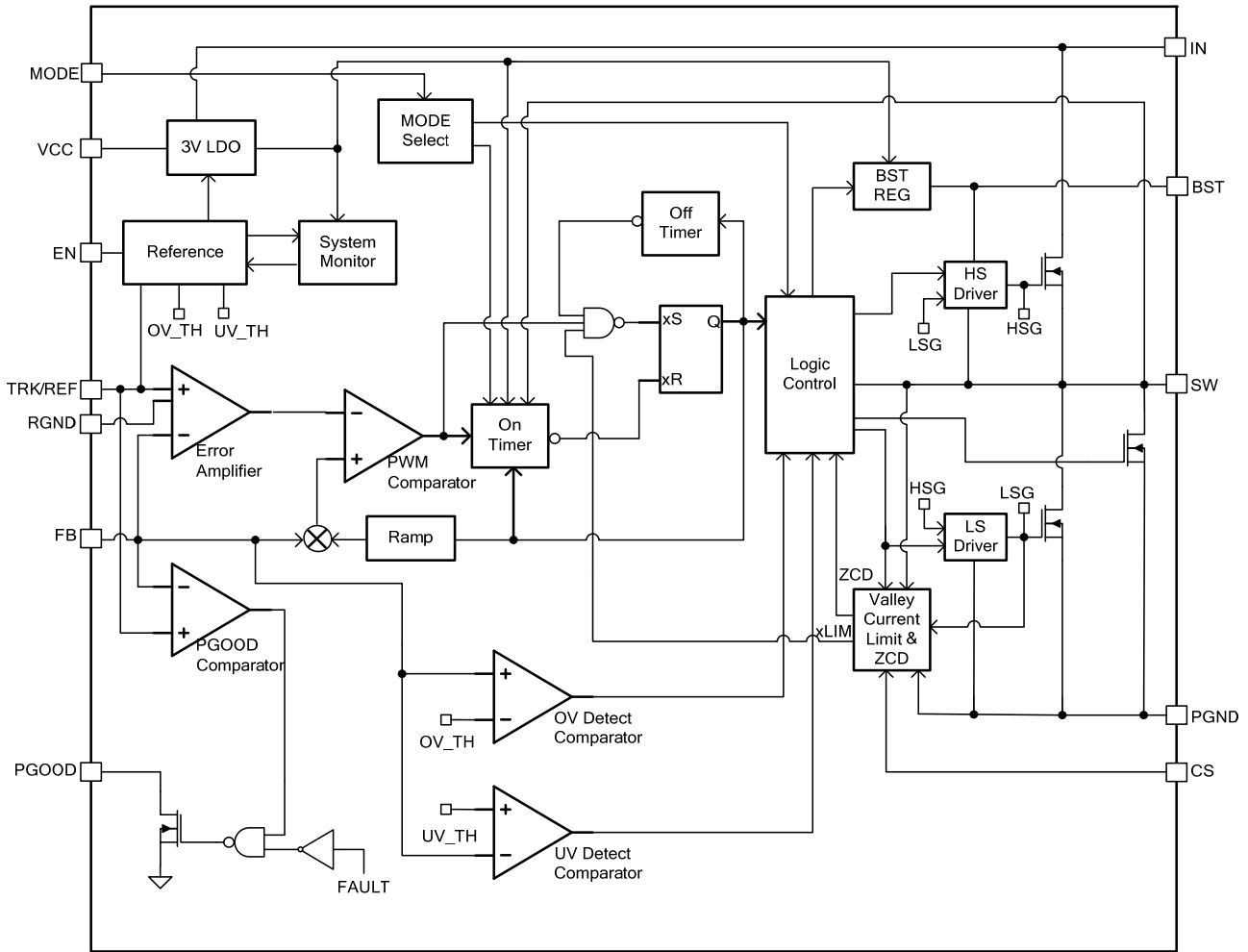

Figure 1: Functional Block Diagram

OPERATION

COT Control

The MPQ8633B employs a constant-on-time (COT) control to achieve a fast load transient response. Figure 2 shows the details of the control stage of the MPQ8633B.

The operational amplifier (AMP) corrects any error voltage between FB and VREF. The MPQ8633B can use AMP to provide excellent load regulation over the entire load range in either forced continuous conduction mode (CCM) or pulse skip mode.

The dedicated RGND pin helps provide the feature of the differential output voltage remote sense. The pair of the remote sense trace should be kept in low impedance to achieve the best performance.

The MPQ8633B has an internal RAMP compensation to support a low ESR MLCC output capacitor solution. The adaptive internal RAMP is optimized so that the MPQ8633B is stable in the entire operating input and output voltage ranges with a proper design of the output L/C filter.

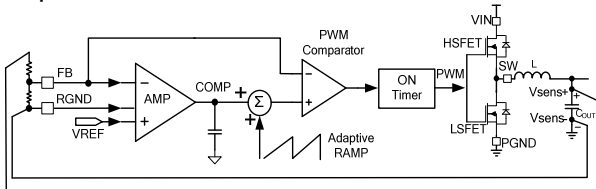

Figure 2: COT Control

PWM Operation

Figure 3 shows how the PWM signal is generated. AMP corrects any error between FB and REF and generates a fairly smooth DC voltage (COMP). The internal RAMP is superimposed onto COMP, which is compared with the FB signal. Whenever FB drops below the superimposed COMP, the integrated high-side MOSFET (HS-FET) is turned on. The HS-FET remains on for a fixed turn-on time. The fixed on time is determined by the input voltage, output voltage, and selected switching frequency. After the on period elapses, the HS-FET turns off. It turns on again when FB drops below the superimposed COMP. By repeating this operation, the MPQ8633B regulates the output voltage. The integrated low-side

MOSFET (LS-FET) turns on when the HS-FET is in its off state to minimize conduction loss. A dead short occurs between VIN and PGND if both the HS-FET and the LS-FET are turned on at the same time. This is called a shoot-through. To avoid a shoot-through, a dead time (DT) is generated internally between the HS-FET off and the LS-FET on period or the LS-FET off and the HS-FET on period.

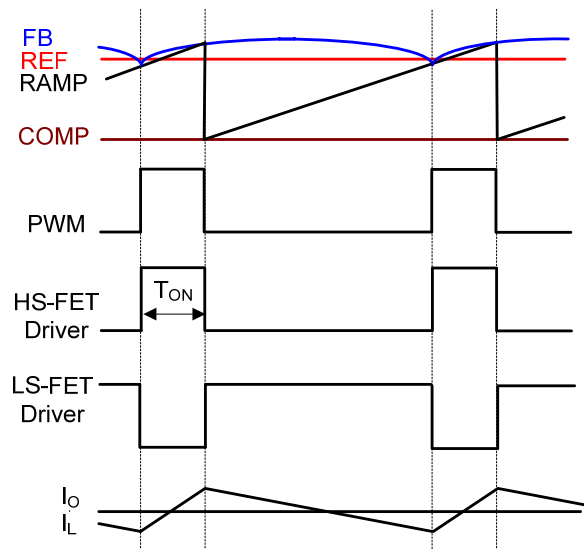

Figure 3: Heavy-Load Operation (PWM)

CCM Operation

Continuous conduction mode (CCM) occurs when the output current is high, and the inductor current is always above zero amps (see Figure 3). The MPQ8633B can also be configured to operate in forced CCM operation when the output current is low (see the Mode Selection section on page 14 for details).

In CCM operation, the switching frequency is fairly constant (PWM mode), hence the output ripple remains almost constant throughout the entire load range.

Pulse Skip Operation

In light-load condition, the MPQ8633B can be configured to work in pulse skip mode to optimize efficiency. When the load decreases, the inductor current decreases as well. Once the inductor current reaches zero, the MPQ8633B transitions from CCM to pulse skip mode if the MPQ8633B is configured in this

way (see the Mode Selection section on page 14 for details).

Figure 4 shows pulse skip mode operation at light-load condition. When FB drops below the superimposed COMP, the HS-FET turns on for a fixed interval. When the HS-FET turns off, the LS-FET turns on until the inductor current reaches zero. In pulse skip mode operation, FB does not reach superimposed COMP when the inductor current approaches zero. The LS-FET driver turns into tri-state (high-Z) when the inductor current reaches zero. A current modulator takes over the control of the LS-FET and limits the inductor current to less than -1mA. Therefore, the output capacitors discharge slowly to PGND through the LS-FET. At light-load condition, the HS-FET is not turned on as frequently in pulse skip mode as it is in forced CCM. As a result, the efficiency in pulse skip mode is improved greatly compared to that in forced CCM operation.

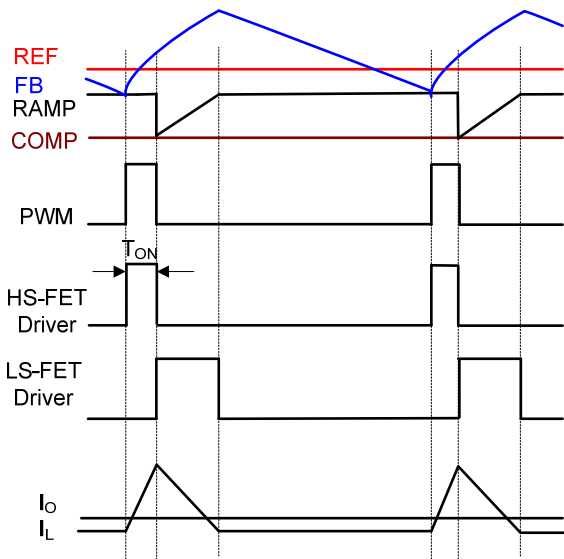

Figure 4: Pulse Skip in Light Load

As the output current increases from light load, the time period the current modulator regulates in becomes shorter. The HS-FET is turned on more frequently, and the switching frequency increases accordingly. The output current reaches critical levels when the current modulator time is zero. The critical level of the output current can be determined with Equation (1):

$$I_{OUT} = \frac{(V_{IN} - V_{OUT}) \times V_{OUT}}{2 \times L \times F_{SW} \times V_{IN}} \quad (1)$$

Where F_{SW} is the switching frequency.

The MPQ8633B enters PWM mode once the output current exceeds the critical level. Afterward, the switching frequency remains fairly constant over the output current range.

The MPQ8633B can be configured to operate in forced CCM, even in light-load condition (see Table 1).

Mode Selection

The MPQ8633B provides both forced CCM operation and pulse skip mode operation in light-load condition. The MPQ8633B has three options for switching frequency selection. Selecting the operation mode under light-load condition and the switching frequency is done by choosing the resistance value of the resistor connected between MODE and AGND or VCC (see Table 1).

Table 1: MODE Selection

MODE	Light-Load Mode	Switching Frequency
VCC	Pulse skip	600kHz
243kΩ (±20%) to GND	Pulse skip	800kHz
121kΩ (±20%) to GND	Pulse skip	1000kHz
GND	Forced CCM	600kHz
30.1kΩ (±20%) to GND	Forced CCM	800kHz
60.4kΩ (±20%) to GND	Forced CCM	1000kHz

Soft Start (SS)

The minimum soft-start time is limited at 1ms. It can be increased by adding a SS capacitor between TRK/REF and RGND.

The total SS capacitor value can be determined with Equation (2) and (3):

$$C_{SS} \text{ (nF)} = \frac{t_{ss} \text{ (ms)} \times 36\mu\text{A}}{0.6 \text{ (V)}} \quad (2)$$

$$C_{SS} = C_{SS1} + C_{SS2} \quad (3)$$

where C_{SS2} is recommended to be minimum of 22nF.

Output Voltage Tracking and Reference

The MPQ8633B provides an analog input pin (TRK/REF) to track another power supply or accept an external reference. When an external voltage signal is connected to TRK/REF, it acts as a reference for the MPQ8633B output voltage. The FB voltage follows this external voltage signal exactly, and the soft-start settings are ignored. The TRK/REF input signal can be in the range of 0.3V to 1.4V. During the initial start-up, the TRK/REF must reach at least 600mV first to ensure proper operation. After that, it can be set to any value between 0.3V and 1.4V.

Pre-Bias Start-Up

The MPQ8633B is designed for monotonic start-up into pre-biased loads. If the output is pre-biased to a certain voltage during start-up, the IC disables switching for both the HS-FET and LS-FET until the voltage on the TRK/REF capacitor exceeds the sensed output voltage at FB. Before the TRK/REF voltage reaches the pre-biased FB level, if the BST voltage (from BST to SW) is lower than 2.3V, the LS-FET is turned on to allow the BST voltage to be charged through VCC. The LS-FET is turned on for very narrow pulses, so the drop in the pre-biased level is negligible.

Output Voltage Discharge

When the MPQ8633B is disabled through EN, output voltage discharge mode is enabled. This causes both the HS-FET and the LS-FET to latch off. A discharge FET connected between SW and PGND is turned on to discharge the output voltage. The typical switch on resistance of this FET is about 80Ω. Once the FB voltage drops below 10%*REF, the discharge FET is turned off.

Current Sense and Over-Current Protection (OCP)

The MPQ8633B features an on-die current sense and a programmable positive current limit threshold.

The current limit is active when the MPQ8633B is enabled. During the LS-FET on state, the SW current (inductor current) is sensed and mirrored to CS with the ratio of G_{CS} . By using a resistor (R_{CS}) from CS to AGND, the V_{CS}

voltage is proportional to the SW current cycle-by-cycle. The HS-FET is only allowed to turn on when V_{CS} is below the internal OCP voltage threshold (V_{OCP}) during the LS-FET on state to limit the SW valley current cycle-by-cycle.

Calculate the current limit threshold setting from R_{CS} with Equation (4):

$$R_{CS}(\Omega) = \frac{V_{OCP}}{G_{CS} \times (I_{LIM} - \frac{(V_{IN} - V_O) \times V_O}{V_{IN}} \times \frac{1}{2 \times L \times f_s})} \quad (4)$$

Where $V_{OCP} = 1.2V$, $G_{CS} = 10\mu A/A$, and I_{LIM} is the desired output current limit (A).

The OCP hiccup is active 3ms after the MPQ8633B is enabled. Once OCP hiccup is active, if the MPQ8633B detects the over-current condition for 31 consecutive cycles, or if FB drops below the under-voltage protection (UVP) threshold, it enters hiccup mode. In hiccup mode, the MPQ8633B latches off the HS-FET immediately, and latches off the LS-FET after ZCD is detected. Meanwhile, the TRK/REF capacitor is also discharged. After about 11ms, the MPQ8633B attempts to soft start automatically. If the over-current condition still remains after 3ms of running, the MPQ8633B repeats this operation cycle until the over-current condition disappears, and the output voltage rises back to the regulation level smoothly.

Negative Inductor Current Limit

When the LS-FET detects a -10A current, the MPQ8633B turns off the LS-FET for 200ns to limit the negative current.

Output Sinking Mode (OSM)

The MPQ8633B employs output sinking mode (OSM) to regulate the output voltage to the targeted value. When the FB voltage is higher than 104%*REF but is below the OVP threshold, OSM is triggered. During OSM operation, the LS-FET remains on until it reaches the -9A current limit. The LS-FET is then turned off momentarily for 200ns before turning on again. The MPQ8633B repeats this operation until FB drops below 102%*REF. The MPQ8633B exits OSM after 15 consecutive cycles of forced CCM.

Over-Voltage Protection (OVP)

The MPQ8633B monitors the output voltage by connecting FB to the tap of the output voltage feedback resistor divider to detect an over-voltage condition. This provides latch-off OVP mode.

If the FB voltage exceeds 116% of the REF voltage, the MPQ8633B enters latch-off OVP mode. The HS-FET latches off and PGOOD latches low until VCC or EN is recycled (turned off and turned on again). Meanwhile, the LS-FET remains on until it reaches the low-side negative current limit (NOCP). The LS-FET is then turned off momentarily for 200ns before turning on again. The MPQ8633B repeats this operation to attempt to bring down the output voltage. When the FB voltage drops below 50% of the REF voltage, the LS-FET is turned off for pulse skip mode and continues turning on for forced CCM operation. If FB rises higher than 116% of the REF voltage again, the LS-FET turns on again with NOCP until FB drops back below 50% of the REF voltage. The MPQ8633B needs EN or VIN to recycle to clear the OVP fault.

The OVP function is enabled after TRK/REF reaches 600mV.

Over-Temperature Protection (OTP)

The MPQ8633B has over-temperature protection (OTP). The IC monitors the junction temperature internally. If the junction temperature exceeds the threshold value (typically 160°C), the converter shuts off and discharges the TRK/REF capacitors. This is a non-latch protection. There is a hysteresis of about 30°C. Once the junction temperature drops to about 130°C, a soft start is initiated. The OTP function is effective once the MPQ8633B is enabled.

Output Voltage Setting and Remote Output Voltage Sensing

First, choose a value for R_{FB1} . Then R_{FB2} can be determined with Equation (5):

$$R_{FB2}(\text{k}\Omega) = \frac{V_{REF}}{V_O - V_{REF}} \times R_{FB1}(\text{k}\Omega) \quad (5)$$

To optimize the load transient response, a feed-forward capacitor (C_{FF}) is recommended to be placed in parallel with R_{FB1} . R_{FB1} and C_{FF} add an extra zero to the system, which improves loop response. R_{FB1} and C_{FF} are selected so that the zero formed by R_{FB1} and C_{FF} is located around 20kHz~60kHz. Calculate this zero with Equation (6):

$$f_z = \frac{1}{2\pi \times R_{FB1} \times C_{FF}} \quad (6)$$

Power Good (PGOOD)

The MPQ8633B has a power good (PGOOD) output. PGOOD is the open-drain of a MOSFET. Connect PGOOD to VCC or another external voltage source less than 3.6V through a pull-up resistor (typically 10kΩ). After applying the input voltage, the MOSFET turns on, so PGOOD is pulled to GND before TRK/REF is ready. After the FB voltage reaches 92.5% of the REF voltage, PGOOD is pulled high after a 0.8ms delay.

When the FB voltage drops to 80% of the REF voltage, or exceeds 116% of the nominal REF voltage, PGOOD is latched low. PGOOD can only be pulled high again after a new SS.

If the input supply fails to power the MPQ8633B, PGOOD is clamped low, even though PGOOD is tied to an external DC source through a pull-up resistor. The relationship between the PGOOD voltage and the pull-up current is shown in Figure 5.

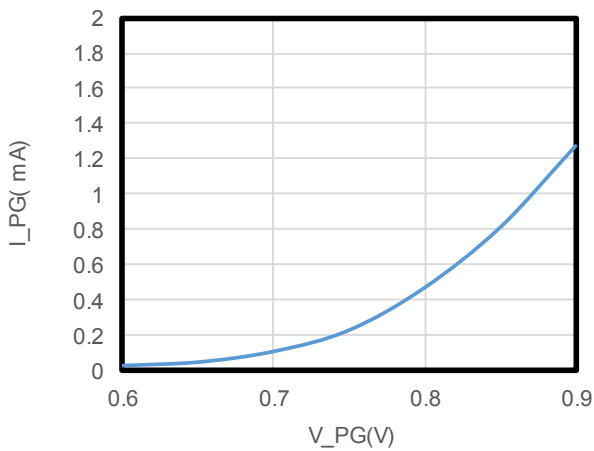

Figure 5: PGOOD Clamped Voltage vs. Pull-Up Current Enable (EN) Configuration

The MPQ8633B turns on when EN goes high; the MPQ8633B turns off when EN goes low. EN cannot be left floating for proper operation. EN can be driven by an analog or digital control logic signal to enable or disable the MPQ8633B.

The MPQ8633B provides accurate EN thresholds, so a resistor divider from VIN to AGND can be used to program the input voltage, at which the MPQ8633B is enabled. This is highly recommended for applications where there is no dedicated EN control logic signal to avoid possible UVLO bouncing during power-up and power-down. The resistor divider values can be determined with Equation (7):

$$V_{IN_START} (V) = V_{IH_EN} \times \frac{R_{UP} + R_{DOWN}}{R_{DOWN}} \quad (7)$$

Where V_{IH_EN} is 1.22V, typically.

R_{UP} and R_{DOWN} should be chosen so that V_{EN} does not exceed 3.6V when VIN reaches the maximum value.

EN can also be connected to VIN directly through a pull-up resistor (R_{UP}). R_{UP} should be chosen so that the maximum current going to EN is 50 μ A. R_{UP} can be calculated with Equation (8):

$$R_{UP} (K\Omega) = \frac{V_{INMAX} (V)}{0.05(mA)} \quad (8)$$

APPLICATION INFORMATION

Input Capacitor

The input current to the step-down converter is discontinuous and therefore requires a capacitor to supply AC current to the step-down converter while maintaining the DC input voltage. Use ceramic capacitors for the best performance. During layout, place the input capacitors as close to VIN as possible.

The capacitance can vary significantly with temperature. Capacitors with X5R and X7R ceramic dielectrics are recommended because they are fairly stable over a wide temperature range and offer very low ESR.

The capacitors must have a ripple current rating that exceeds the converter's maximum input ripple current. Estimate the input ripple current with Equation (9):

$$I_{CIN} = I_{OUT} \times \sqrt{\frac{V_{OUT}}{V_{IN}} \times \left(1 - \frac{V_{OUT}}{V_{IN}}\right)} \quad (9)$$

The worst-case condition occurs at $V_{IN} = 2V_{OUT}$, shown in Equation (10):

$$I_{CIN} = \frac{I_{OUT}}{2} \quad (10)$$

For simplification, choose an input capacitor with an RMS current rating that exceeds half the maximum load current. The input capacitor value determines the converter input voltage ripple. If there is an input voltage ripple requirement in the system, select an input capacitor that meets the specification.

Estimate the input voltage ripple with Equation (11):

$$\Delta V_{IN} = \frac{I_{OUT}}{F_{SW} \times C_{IN}} \times \frac{V_{OUT}}{V_{IN}} \times \left(1 - \frac{V_{OUT}}{V_{IN}}\right) \quad (11)$$

The worst-case condition occurs at $V_{IN} = 2V_{OUT}$, where:

$$\Delta V_{IN} = \frac{1}{4} \times \frac{I_{OUT}}{F_{SW} \times C_{IN}} \quad (12)$$

Output Capacitor

The output capacitor maintains the DC output voltage. Use POSCAP or ceramic capacitors. Estimate the output voltage ripple with Equation (13):

$$\Delta V_{OUT} = \frac{V_{OUT}}{F_{SW} \times L} \times \left(1 - \frac{V_{OUT}}{V_{IN}}\right) \times \left(R_{ESR} + \frac{1}{8 \times F_{SW} \times C_{OUT}}\right) \quad (13)$$

When using ceramic capacitors, the capacitance dominates the impedance at the switching frequency. The capacitance also dominates the output voltage ripple. For simplification, estimate the output voltage ripple with Equation (14):

$$\Delta V_{OUT} = \frac{V_{OUT}}{8 \times F_{SW}^2 \times L \times C_{OUT}} \times \left(1 - \frac{V_{OUT}}{V_{IN}}\right) \quad (14)$$

For simplification, the output ripple can be approximated with Equation (15):

$$\Delta V_{OUT} = \frac{V_{OUT}}{F_{SW} \times L} \times \left(1 - \frac{V_{OUT}}{V_{IN}}\right) \times R_{ESR} \quad (15)$$

Inductor

The inductor supplies a constant current to the output load while being driven by the switching input voltage. A larger value inductor results in less ripple current and lower output ripple voltage, but also has a larger physical size, a higher series resistance, and a lower saturation current. Generally, select an inductor value that allows the inductor peak-to-peak ripple current to be 30% to 40% of the maximum switch current limit. Also design for a peak inductor current that is below the maximum switch current limit. Calculate the inductance value with Equation (16):

$$L = \frac{V_{OUT}}{F_{SW} \times \Delta I_L} \times \left(1 - \frac{V_{OUT}}{V_{IN}}\right) \quad (16)$$

Where ΔI_L is the peak-to-peak inductor ripple current.

Choose an inductor that will not saturate under the maximum inductor peak current. The peak inductor current can be calculated with Equation (17):

$$I_{LP} = I_{OUT} + \frac{V_{OUT}}{2 \times F_{SW} \times L} \times \left(1 - \frac{V_{OUT}}{V_{IN}}\right) \quad (17)$$

