

H
G
F
E
D
C
B
A

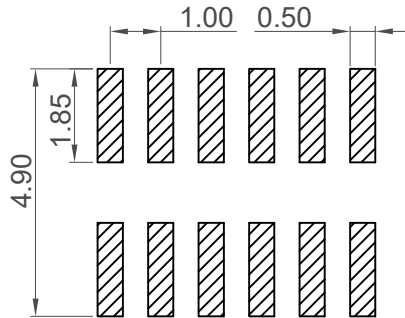

Recommended PCB Layout
For Top Entry
General Tolerance: ±0.05
Solder Area

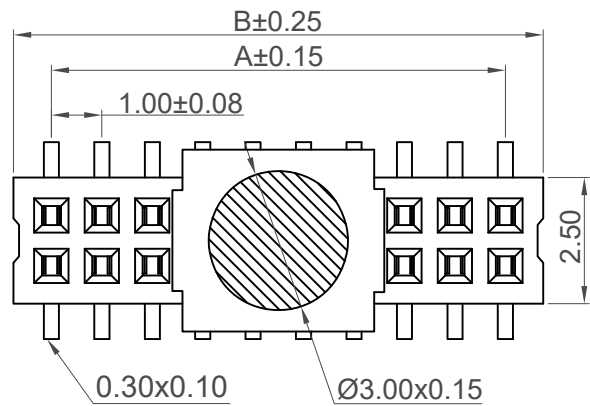
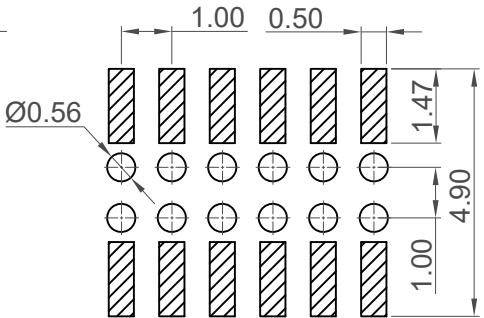

Recommended PCB Layout
For Bottom Entry
General Tolerance: ±0.05
Solder Area

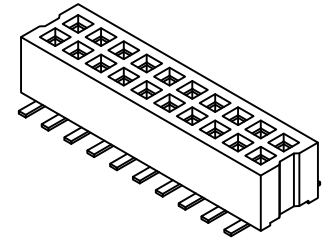
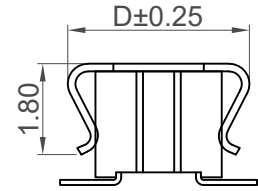
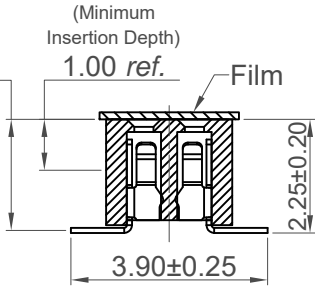
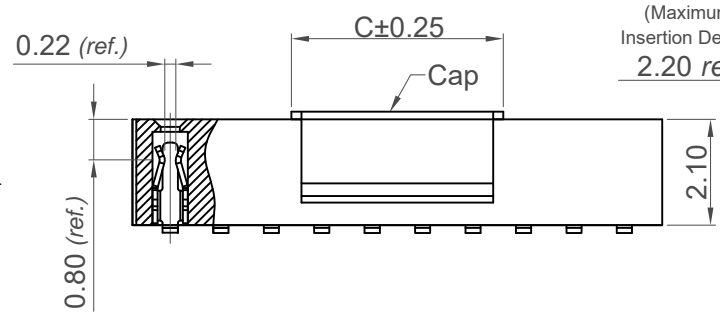

No. of Contacts	Dimensions			
	A	B	C	D
4	1.00	2.50	3.00	3.85
6	2.00	3.50		
8	3.00	4.50	4.20	3.40
10	4.00	5.50		
12	5.00	6.50		
14	6.00	7.50		
16	7.00	8.50		
18	8.00	9.50		
20	9.00	10.50		
22	10.00	11.50		
24	11.00	12.50		
26	12.00	13.50		
28	13.00	14.50		
30	14.00	15.50		
32	15.00	16.50		
34	16.00	17.50		
36	17.00	18.50		
38	18.00	19.50		
40	19.00	20.50		
42	20.00	21.50		
44	21.00	22.50		
46	22.00	23.50		
48	23.00	24.50		
50	24.00	25.50		
52	25.00	26.50		
54	26.00	27.50		
56	27.00	28.50		
58	28.00	29.50		
60	29.00	30.50		
62	30.00	31.50		
64	31.00	32.50		
66	32.00	33.50		
68	33.00	34.50		
70	34.00	35.50		
72	35.00	36.50		
74	36.00	37.50		
76	37.00	38.50		
78	38.00	39.50		
80	39.00	40.50		

Specifications

Material
Insulator: LCP, UL94V-0, Black
Contact: Phosphor Bronze

Plating
See ordering grid

Electrical
Current Rating: 1A per contact
Contact Resistance: 40 mΩ max.
Insulating Resistance: 500 MΩ min.
Dielectric Withstand Voltage: 200V AC

Mechanical & Environmental
Operating Temperature: -40°C to +105°C
Soldering Process:
IR Reflow: 260°C for 10 sec.
Manual Solder: 350°C for 3-5 sec

Mates with (subject to pin length):
BC035 BC036 BC040 BC045
BC050 BC055 BC057

Ordering Grid
BC085-XX-X-0390-L-X

No. of Contacts: 04 to 80
Contact Plating: A = Gold Flash All Over (Standard), C = Tin All Over
Footprint Width (1/100mm): 0390 = 3.90mm

Packing Options
C = Tape and Reel with Film (Standard)
B = Tape and Reel with Cap
D = Tube
E = Tube with Cap
F = Tube with Film (Unavailable for 4 contacts)

Insulator Material
L = LCP (Standard)

Request Samples and Quotation

Part Number BC085		Product Description 1.00mm Pitch Socket, Dual Entry Dual Row, Surface Mount, Vertical	
Drawing Date 20th May 2008			
By	CC	Tolerances (Except as Noted)	Units: Metric (mm)
Detail	BC085 F PCN	Length: X. ± 0.30 Angle: XX ± 0.25	Angle: X° ± 5° X.X° ± 2°
Revision	F4	XXX ± 0.15	XXX° ± 1°
Date	06/09/21	X.XXX ± 0.10	X.XXX° ± 0.5°



This drawing is confidential and copyright of Global Connector Technology, Ltd (GCT). This drawing must not be copied or disclosed without written consent. E & OE



Not to Scale	Drawn By AJO	Sheet No. 1/1
--------------	-----------------	------------------