

SERIES: PDQE30-D | **DESCRIPTION:** DC-DC CONVERTER

FEATURES

- 30W isolated output
- 1500 Vdc isolation
- 1 x 1 inch industry standard package
- ultra-wide 4:1 input voltage range
- EN62368 approved
- wide temperature range: -40°C to +85°C
- high efficiency up to 88%
- input under-voltage protection, output short circuit, over-current, over-voltage protection

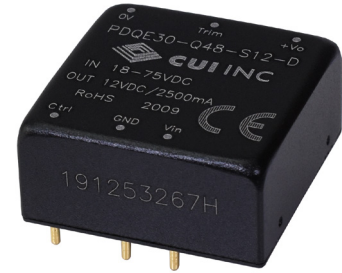

MODEL	input voltage		output voltage (Vdc)	output current		output power max (W)	ripple and noise ¹ max (mVp-p)	efficiency typ (%)
	typ (Vdc)	range (Vdc)		min (mA)	max (mA)			
PDQE30-Q48-S5-D	48	18~75	5	0	6000	30	120	88
PDQE30-Q48-S12-D	48	18~75	12	0	2500	30	120	88
PDQE30-Q48-S15-D	48	18~75	15	0	2000	30	120	88
PDQE30-Q48-S24-D	48	18~75	24	0	1250	30	150	88

Note: 1. Ripple & noise testing condition at nominal input voltage and 5%-100% load, 20MHz bandwidth

PART NUMBER KEY

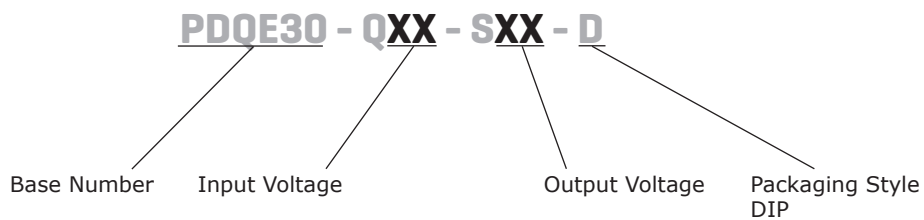

INPUT

parameter	conditions/description	min	typ	max	units
input voltage		18	48	75	Vdc
start-up voltage	nominal input voltage			18	Vdc
surge voltage	nominal input voltage	-0.7		100	Vdc
filter	capacitance filter				
current	nominal input voltage (full load/no load)		710/8	735/15	mA
under-voltage lockout		12	15.5		Vdc
start-up time	nominal input voltage		10		mS
CTRL ¹	module on - open or pulled high	3.5		12	Vdc
	module off - pulled low to GND	0		1.2	Vdc
	input current when off		2	7	mA

Note: 1. CTRL is referenced to GND

OUTPUT

parameter	conditions/description	min	typ	max	units
line regulation	min to max Vin		±0.2	±0.5	%
load regulation	5% ~ 100% load		±0.5	±1	%
set-point accuracy			±1	±3	%
switching frequency	PWM mode		270		kHz
transient response	25% load step change		±3	±8	%
	5V output		±3	±5	%
	others				
temperature coefficient	full load			±0.03	%/°C
adjustability	via trim pin		±10		%

PROTECTIONS

parameter	conditions/description	min	typ	max	units
over voltage protection		110		160	%Vo
over current protection		110		260	%Io
short circuit protection	continuous, self-recovery				

SAFETY AND COMPLIANCE

parameter	conditions/description	min	typ	max	units
isolation voltage	input-output electric strength test for 1 minute	1500			Vdc
isolation resistance	input-output insulation at 500 Vdc	1000			MΩ
isolation capacitance	input-output capacitance at 100 KHz / 0.1 V		2000		pF
safety approvals	EN62368 approved				
EMC	CISPR32/EN55032 Class B (see recommended circuit)				
ESD	IEC/EN61000-4-2, Contact ±6K, perf. Criteria B				
radiated immunity	IEC/EN61000-4-3, 10 v/m, perf. Criteria B				
EFT/burst	IEC/EN61000-4-4, ±2KV, perf. Criteria B (see recommended circuit)				
surge	IEC/EN61000-4-5, line to line ±2KV, perf. Criteria B (see recommended circuit)				
conducted immunity	IEC/EN61000-4-6 3 Vrms, perf. Criteria B				
RoHS	yes				
MTBF	MIL-HDBK-217F @ 25°C	1000			kHours

ENVIRONMENTAL

parameter	conditions/description	min	typ	max	units
operating temperature		-40		85	°C
storage temperature		-55		125	°C
humidity	non-condensing	5		95	%

SOLDERABILITY

parameter	conditions/description	min	typ	max	units
hand soldering	1.5 mm from case for 10 seconds			300	°C

DERATING CURVES

Figure 1

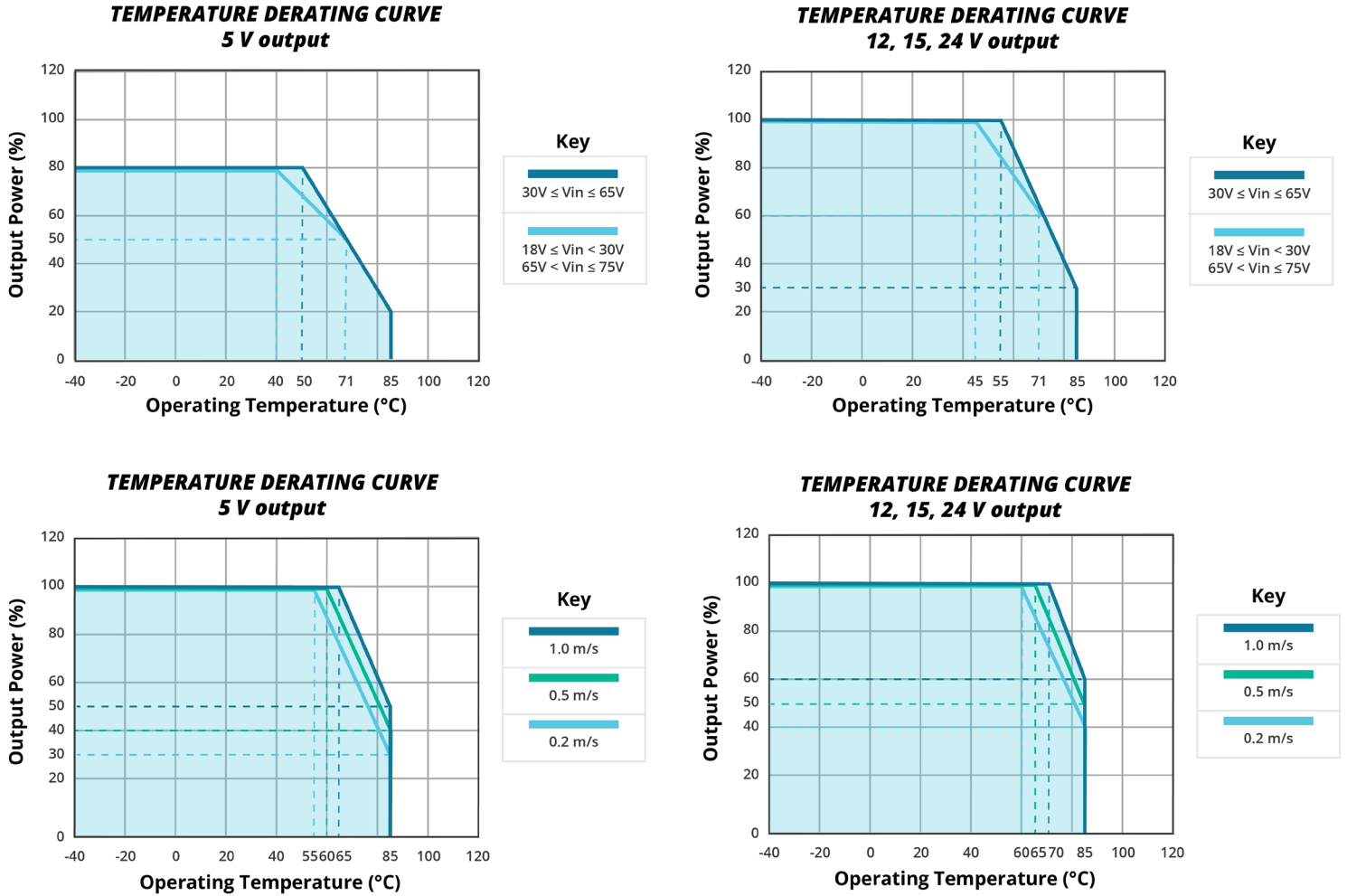

Note:

MECHANICAL

parameter	conditions/description	min	typ	max	units
dimensions	25.40 × 25.40 × 11.70 mm				inch
case material	aluminum alloy				
weight			18.4		g

MECHANICAL DRAWING

units: inches [mm]
tolerance: ± 0.50 [±0.020]

PIN CONNECTIONS	
PIN	FUNCTION
1	Ctrl
2	GND
3	Vin
4	Vo
5	Trim
6	0V

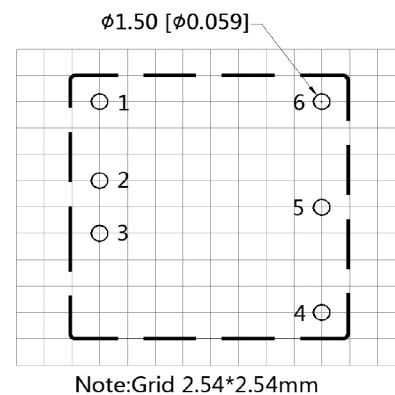
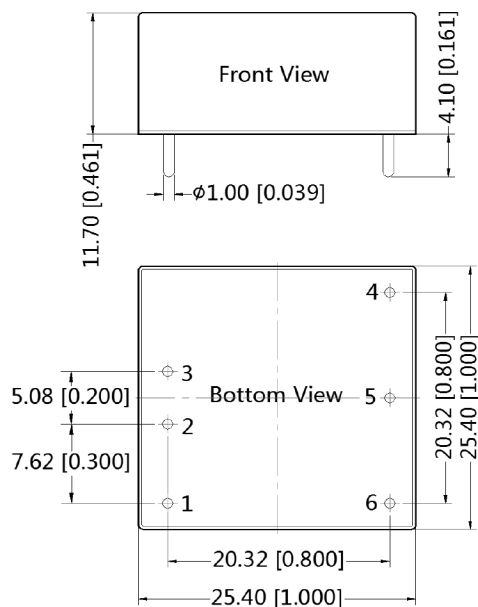

TYPICAL APPLICATION CIRCUIT

Figure 2

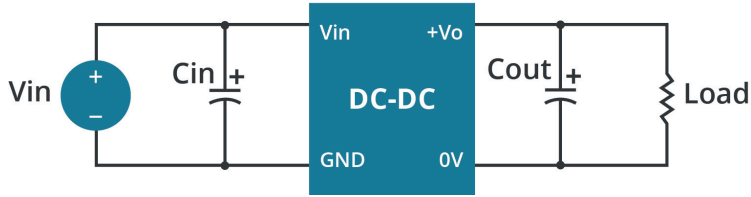

Vout (Vdc)	Cin (μF)	Cout (μF)
5/12/15	100	100
24		47

EMC COMPLIANCE CIRCUITS

Figure 3

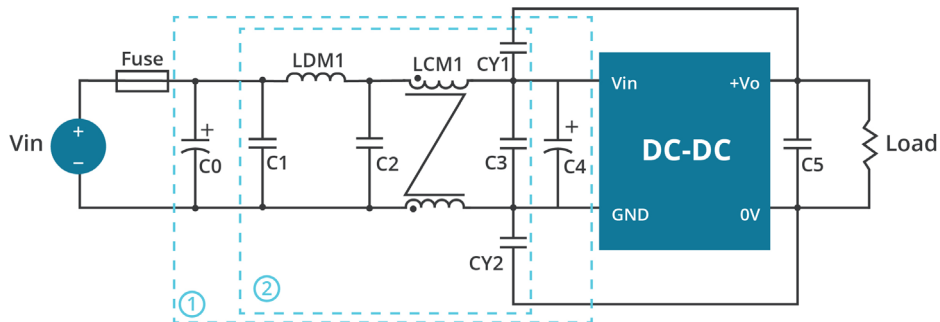

Note: We use Part ① in Fig. 3 for Immunity tests and Part ② for Emissions test. Selecting based on needs.

Model	Vin: 48 V
FUSE	Choose according to actual input current
C0, C4	470μF/100V
C1	10μF/100V
LDM1	22uH/3A
C2	22uF/100V
LCM1	1.4mH/3A
C3	22uF/100V
C5	Refer to the Cout Fig.2
CY1, CY2	1nF/2KV

TRIM FUNCTION FOR OUTPUT VOLTAGE ADJUSTMENT

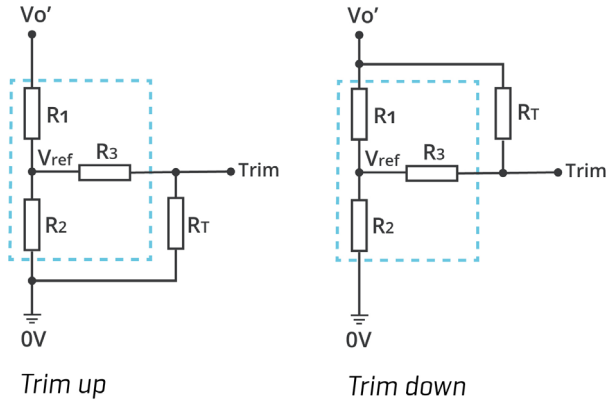

Calculating trim resistor values

$$\begin{aligned} \text{up: } R_T &= \frac{a R_2}{R_2 - a} - R_3 & a &= \frac{V_{ref}}{V_{o'} - V_{ref}} \cdot R_1 \\ \text{down: } R_T &= \frac{a R_1}{R_1 - a} - R_3 & a &= \frac{V_{o'} - V_{ref}}{V_{ref}} \cdot R_2 \end{aligned}$$

Trim resistor connection (dashed line shows internal resistor network).

R_T is Trim resistance a is a self-defined parameter, with no real meaning.

Vout (V)	R1 (KΩ)	R2 (KΩ)	R3 (KΩ)	Vref (V)
5	8.832	2.87	10	1.24
12	11.00	2.87	8.2	2.5
15	14.40	2.87	10	2.5
24	24.87	2.87	7.5	2.5

REVISION HISTORY

rev.	description	date
1.0	initial release	03/28/2020
1.01	derating curve and circuit figures updated	08/24/2021
1.02	adjustability limits added	03/14/2022

The revision history provided is for informational purposes only and is believed to be accurate.



Headquarters
20050 SW 112th Ave.
Tualatin, OR 97062
800.275.4899

Fax 503.612.2383
cui.com
techsupport@cui.com

CUI offers a two (2) year limited warranty. Complete warranty information is listed on our website.

CUI reserves the right to make changes to the product at any time without notice. Information provided by CUI is believed to be accurate and reliable. However, no responsibility is assumed by CUI for its use, nor for any infringements of patents or other rights of third parties which may result from its use.

CUI products are not authorized or warranted for use as critical components in equipment that requires an extremely high level of reliability. A critical component is any component of a life support device or system whose failure to perform can be reasonably expected to cause the failure of the life support device or system, or to affect its safety or effectiveness.