

REVISIONS					
REV	ECO	DESCRIPTION	DATE	BY	APPR
A1	-	RELEASE	5JUL17	JAH	
A2	-	ADDED REDUCED DIAMETER SEAL P/N'S	28JAN19	JAH	
A3	-	REVISED TITLE	14JUN19	JAH	

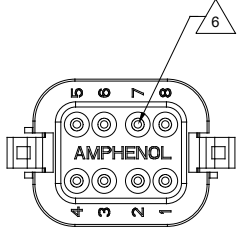

REQUIRES CONTACT RETENTION WEDGE AW8S

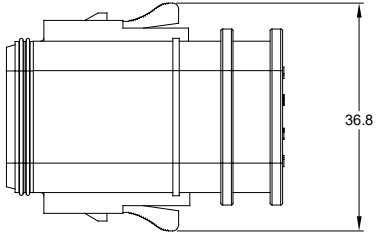
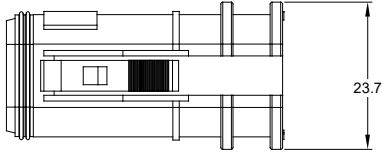
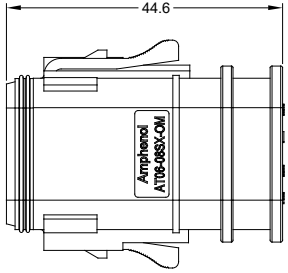
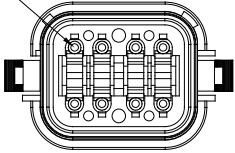

NOTES: UNLESS OTHERWISE SPECIFIED

- MATERIAL:  
HOUSING: PA66 GF15  
SEE SHEET 2 FOR KEY ARRANGEMENTS AND COLORS  
SEALS: SILICONE RUBBER
- MODIFICATIONS: FOR OVER MOLDING
- SPECIFICATIONS:
  - CURRENT RATING: 13 AMPS
  - OPERATING TEMPERATURE: -55°C TO +125°C
  - DIELECTRIC WITHSTANDING VOLTAGE: LESS THAN 2 MILLIAMPS CURRENT LEAKAGE @ 1500 VOLTS AC.
  - INSULATION RESISTANCE: 1000 MEGOHMS MIN @ 25°C.
  - MOISTURE RESISTANCE: IP67 ( MATED CONDITION )
  - MATING CYCLE DURABILITY: 100 CYCLES
  - RoHS COMPLIANT
- MATING PART: AT04-08P\* RECEPTACLE  
( \* X = A,B,C,D KEYS; \* = MODIFICATIONS AND COLORS )
- ALL DIMENSIONS ARE FOR REFERENCE USE ONLY.

△ CONTACT SIZE AND REAR SEAL WIRE RANGE:

STANDARD SEAL

CONTACT SIZE	MIN. INSUL O.D.	MAX. INSUL O.D.	TYPICAL WIRE RANGE
16	2.24 mm (.088 in)	3.68 mm (.145 in)	14 - 20 AWG

REDUCED DIAMETER SEAL

CONTACT SIZE	MIN. INSUL O.D.	MAX. INSUL O.D.	TYPICAL WIRE RANGE
16	1.35 mm (.053 in)	3.05 mm (.120 in)	14 - 20 AWG

REFER TO PART NUMBER CHART FOR AVAILABLE CONNECTOR COLORS

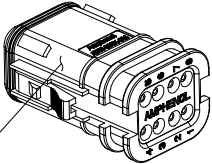

TITLE: STRUCTURE+, OVERMOLD-COMPATIBLE PLUG, 8 SOCKET, AT  
DWG NO.: AT06-08SX-OMXXX  
REV: A3  
SH: 1  
QF: 2

QUANTITY	PART NUMBER	DESCRIPTION	ITEM
<b>MATERIALS LIST</b>			
UNLESS OTHERWISE SPECIFIED: 1) All dimensions are in metric (mm). 2) Tolerances are as follows: 1 PL DEC ±0.30   Fractions ±1/64 2 PL DEC ±0.15   Angles ±1° 3 PL DEC ±0.08 3) Note reference = △		SIGNATURES: J. HEAD DATE: 5JUL2017 CHECKED: - ENGINEER: - APPROVAL: - CUSTOMER: -	<div style="text-align: center;"> <h1>Amphenol</h1> <p>Sine Systems - www.amphenol-sine.com 44724 Morley Drive Clinton Township, MI 48036</p> </div>
MATERIAL SPECIFICATIONS:  PROCESS SPECIFICATIONS:  NEXT ASSY:		THIS DRAWING IS SUPPLIED FOR INFORMATION ONLY. DESIGN FEATURES, SPECIFICATIONS AND PERFORMANCE DATA SHOWN HEREON ARE THE PROPERTY OF THE AMPHENOL CORPORATION. NO RIGHTS OF REPRODUCTION ARE IMPLIED. ALL DIMENSIONS ARE SUBJECT TO NORMAL MANUFACTURING VARIATIONS.	
		SIZE: B C- TYPE: - DWG NO.: AT06-08SX-OMXXX SCALE: NONE	REVISION: A3 SHEET 1 OF 2

REVISIONS					
REV	ECO	DESCRIPTION	DATE	BY	APPR
A1	-	RELEASE	5JUL17	JAH	
A2	-	ADDED REDUCED DIAMETER SEAL P/N'S	28JAN19	JAH	
A3	-	REVISED TITLE	14JUN19	JAH	

P/N AT06-08SA-OMXXX  
KEY-A CONFIGURATION  
COLOR: GREY

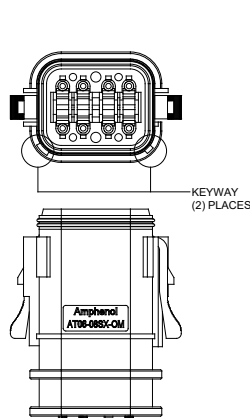

P/N AT06-08SB-OMXXX  
KEY-B CONFIGURATION  
COLOR: BLACK

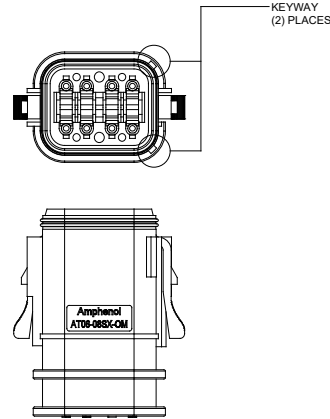

P/N AT06-08SC-OMXXX  
KEY-C CONFIGURATION  
COLOR: GREEN

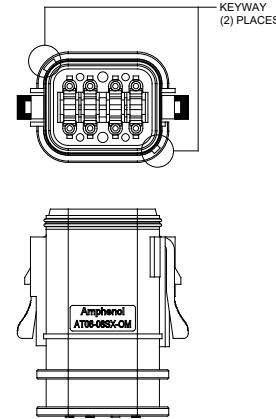

P/N AT06-08SD-OMXXX  
KEY-D CONFIGURATION  
COLOR: BROWN

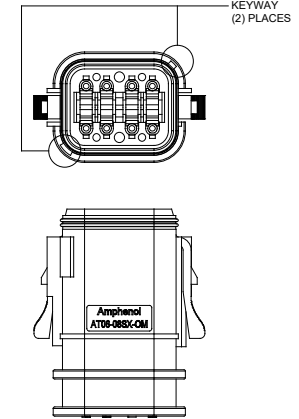

KEY-A CONFIGURATION		
COLOR	P/N W/ STD SEAL	P/N W/ RD SEAL
<b>* GREY</b>	<b>AT06-08SA-OMGRY</b>	<b>AT06-08SA-OMRDGRY</b>
BLACK	AT06-08SA-OMBLK	AT06-08SA-OMRDBLK
GREEN	AT06-08SA-OMGRN	AT06-08SA-OMRDGRN
BROWN	AT06-08SA-OMBRN	AT06-08SA-OMRDBRN

KEY-B CONFIGURATION		
COLOR	P/N W/ STD SEAL	P/N W/ RD SEAL
GREY	AT06-08SB-OMGRY	AT06-08SB-OMRDGRY
<b>* BLACK</b>	<b>AT06-08SB-OMBLK</b>	<b>AT06-08SB-OMRDBLK</b>
GREEN	AT06-08SB-OMGRN	AT06-08SB-OMRDGRN
BROWN	AT06-08SB-OMBRN	AT06-08SB-OMRDBRN

KEY-C CONFIGURATION		
COLOR	P/N W/ STD SEAL	P/N W/ RD SEAL
GREY	AT06-08SC-OMGRY	AT06-08SC-OMRDGRY
BLACK	AT06-08SC-OMBLK	AT06-08SC-OMRDBLK
<b>* GREEN</b>	<b>AT06-08SC-OMGRN</b>	<b>AT06-08SC-OMRDGRN</b>
BROWN	AT06-08SC-OMBRN	AT06-08SC-OMRDBRN

KEY-D CONFIGURATION		
COLOR	P/N W/ STD SEAL	P/N W/ RD SEAL
GREY	AT06-08SD-OMGRY	AT06-08SD-OMRDGRY
BLACK	AT06-08SD-OMBLK	AT06-08SD-OMRDBLK
GREEN	AT06-08SD-OMGRN	AT06-08SD-OMRDGRN
<b>* BROWN</b>	<b>AT06-08SD-OMBRN</b>	<b>AT06-08SD-OMRDBRN</b>

NOTE:

AN ASTERISKS ( \* ) PLACED BEFORE THE COLOR DENOTES THE STANDARD MOLDED COLOR OF THE CONNECTORS SHOWN ABOVE.



OTHER COLORS SHOWN ARE AVAILABLE VIA SPECIAL ORDER.



SEE CHART		DESCRIPTION		ITEM
QUANTITY	PART NUMBER			
<b>MATERIALS LIST</b>				
<small>UNLESS OTHERWISE SPECIFIED</small> 1) All dimensions are in metric(mm). 2) Tolerances are as follows: 1 PL DEC ±0.30 2 PL DEC ±0.15 3 PL DEC ±0.08 3) Note reference = $\Delta$		<small>SIGNATURES</small> DRAWN: J.HEAD CHECKED: . ENGINEER: APPROVAL: CUSTOMER:		<small>DATE</small> 5JUL2017
<small>MATERIAL SPECIFICATIONS:</small> THIS DRAWING IS SUPPLIED FOR INFORMATION ONLY. DESIGN FEATURES, SPECIFICATIONS AND PERFORMANCE DATA SHOWN HEREON ARE THE PROPERTY OF THE AMPHENOL CORPORATION. NO RIGHTS OF REPRODUCTION ARE IMPLIED. ALL DIMENSIONS ARE SUBJECT TO NORMAL MANUFACTURING VARIATIONS.		 Sine Systems - www.amphenol-sine.com 44724 Morley Drive Clinton Township, MI 48036		
<small>PROCESS SPECIFICATIONS:</small> NEXT ASSY:		STRUCTURE+, OVERMOLD-COMPATIBLE PLUG, 8 SOCKET, AT SERIES SIZE: <b>B C-</b> TYPE: NONE DWG NO.: <b>AT06-08SX-OMXXX</b> REVISION: <b>A3</b> SCALE: NONE SHEET 2 OF 2		





TITLE: STRUCTURE+, OVERMOLD-COMPATIBLE PLUG, 8 SOCKET, AT  
DWG NO.: AT06-08SX-OMXXX  
REV: A3  
SH: 2  
OF: 2

# AT Series™ - Contact Size 16 Options



Machined Contacts, Sockets & Pins				
Part Number	Description	Size	AWG	Type
AT60-215-1631	Male Contact - Pin, Gold-plated	16	14	Machined
AT62-209-1631	Female Contact - Socket, Gold-plated	16	14	Machined
AT60-215-16141	Male Contact - Pin, Nickel-plated	16	14	Machined
AT62-209-16141	Female Contact - Socket, Nickel-plated	16	14	Machined
AT60-202-1631	Male Contact - Pin, Gold-plated	16	16-20	Machined
AT62-201-1631	Female Contact - Socket, Gold-plated	16	16-20	Machined
AT60-202-16141	Male Contact - Pin, Nickel-plated	16	16-20	Machined
AT62-201-16141	Female Contact - Socket, Nickel-plated	16	16-20	Machined
AT60-202-1631-22	Male Contact - Pin, Gold-plated	16	22-24	Machined
AT62-201-1631-22	Female Contact - Socket, Gold-plated	16	22-24	Machined
AT60-202-16141-22	Male Contact - Pin, Nickel-plated	16	22-24	Machined
AT62-201-16141-22	Female Contact - Socket, Nickel-plated	16	22-24	Machined

Tooling - Machined Contacts		
Part	Part Number	Description
	CA-5D12	Universal Hand Crimp Tool, Size 12/16/20 (Machined contacts only)
	CA-5E12	Pneumatic Crimp Tool, Size 12/16/20 (Machined contacts only)

Contact Removal Tools		
Part	Part Number	Description
	ART-100	Used for removal of contacts for A Series™ products
	AT11-310-1605	Contact Removal Tool, Plastic, Size 16

Sealing Plugs		
Part	Part Number	Description
	A114017	Sealing Plug, Size 16, White
	A114017-SR	Sealing Plug, Size 16, SR01 Series, Black
	AT13-217-1605	Locking Sealing Plug, Size 16, Grey
	AT13-217-1605-SR	Locking Sealing Plug, Size 16, SR01 Series, Red

Stamped & Formed Contacts, Sockets & Pins				
Part Number	Description	Size	AWG	Type
AT60-14-0144	Male Contact - Pin, Gold-plated	16	14-16	Stamped & Formed
AT62-14-0144	Female Contact - Socket, Gold-plated	16	14-16	Stamped & Formed
AT60-14-0122	Male Contact - Pin, Nickel-plated	16	14-16	Stamped & Formed
AT62-14-0122	Female Contact - Socket, Nickel-plated	16	14-16	Stamped & Formed
AT60-16-0144	Male Contact - Pin, Gold-plated	16	16-18	Stamped & Formed
AT62-16-0144	Female Contact - Socket, Gold-plated	16	16-18	Stamped & Formed
AT60-16-0122	Male Contact - Pin, Nickel-plated	16	16-18	Stamped & Formed
AT62-16-0122	Female Contact - Socket, Nickel-plated	16	16-18	Stamped & Formed
AT60-16-0644	Male Contact - Pin, Gold-plated	16	18-20	Stamped & Formed
AT62-16-0644	Female Contact - Socket, Gold-plated	16	18-20	Stamped & Formed
AT60-16-0622	Male Contact - Pin, Nickel-plated	16	18-20	Stamped & Formed
AT62-16-0622	Female Contact - Socket, Nickel-plated	16	18-20	Stamped & Formed
AT60-16-0844	Male Contact - Pin, Gold-plated	16	20-22	Stamped & Formed
AT62-16-0844	Female Contact - Socket, Gold-plated	16	20-22	Stamped & Formed
AT60-16-0822	Male Contact - Pin, Nickel-plated	16	20-22	Stamped & Formed
AT62-16-0822	Female Contact - Socket, Nickel-plated	16	20-22	Stamped & Formed

Tooling - Stamped & Formed Contacts		
Part	Part Number	Description
	MF-3950	Crimp Die - Size 16, 18-20AWG (S&F contacts only)
	MF-3953	Crimp Die - Size 16, 16-18AWG (S&F contacts only)
	MF-3975	Crimp Die - Size 16, 14-16AWG (S&F contacts only)
	MF-3990	Crimp Die - Size 16, 20-22AWG (S&F contacts only)
	ATT-16-00	Hand Crimp Tool - Size 16, 14-16AWG (S&F contacts only)
	ATT-16-01	Hand Crimp Tool - Size 16, 18-20AWG (S&F contacts only)
	ATT-1612-03	Hand Crimp Tool - Size 16, 20-22AWG (S&F contacts only)

**Amphenol Sine Systems**  
 44724 Morley Drive  
 Clinton Township, MI 48036 USA  
[www.amphenol-sine.com](http://www.amphenol-sine.com)  
 03/2022