

**SERIES:** PQD10W-D | **DESCRIPTION:** DC-DC CONVERTER

**FEATURES**

- ultrawide 4:1 input range
- dual positive output with asymmetrical options
- industry standard pinout
- 1500 Vdc isolation
- input under-voltage protection
- output short circuit, over current, and over-voltage protection
- wide operating temp: -40°C to +85°C
- EN 62368 approved

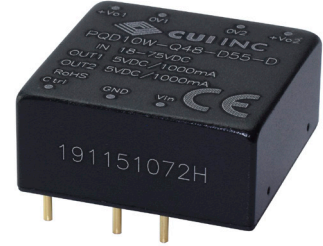

**MODEL**

MODEL	input voltage		output voltage	output current		output power	ripple & noise <sup>1</sup>	efficiency <sup>2</sup>	
	typ (Vdc)	range (Vdc)	Vo1/Vo2 (Vdc)	min (mA)	max (mA)	max (W)	max (mVp-p)	min (%)	typ (%)
PQD10W-Q48-D55-D	48	18~75	5/5	0/0	1000/1000	10	150	81	84
PQD10W-Q48-D512-D	48	18~75	5/12	0/0	1000/417	10	150	82	84
PQD10W-Q48-D524-D	48	18~75	5/24	0/0	1000/209	10	150	82	84

Notes: 1. From 5~100% load, nominal input, 20 MHz bandwidth oscilloscope, with 10 µF tantalum and 1 µF ceramic capacitors on the output. From 0~5% load, ripple and noise is <5% Vo.  
2. Measured at nominal input voltage and rated output load.

**PART NUMBER KEY**

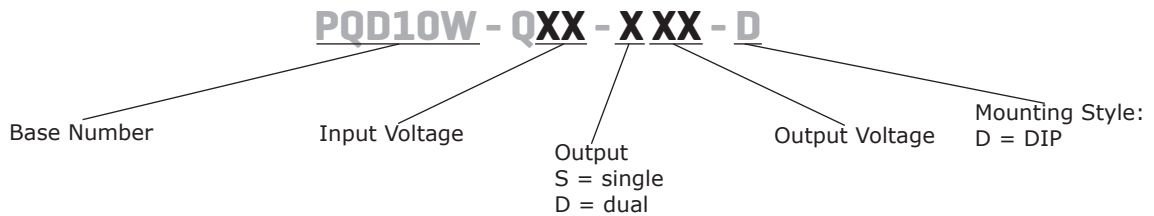

## INPUT

parameter	conditions/description	min	typ	max	units
operating input voltage		18	48	80	Vdc
start-up voltage				18	Vdc
surge voltage	for maximum of 1 second	-0.7		100	Vdc
current	full load / no load, nominal input voltage		248/4	258/10	mA
filter	Pi filter				
CTRL <sup>3</sup>	module on (CTRL open or pulled high 3.5~12 Vdc) module off (CTRL pulled low or to gnd 0~1.2 Vdc)				

Note 3: CTRL is referenced to GND

## OUTPUT

parameter	conditions/description	min	typ	max	units
maximum capacitive load	5 V output			1,000	μF
	12 V output			470	μF
	24 V output			100	μF
voltage accuracy	0% to full load, Vo1 input voltage, any balanced load, Vo2		±1	±3	%
			±3	±6	%
line regulation	from low line to high line, full load Vo1 Vo2		±0.3	±0.5	%
			±2	±3	%
load regulation	from 10% to full load, dual output, balanced power Vo1 Vo2		±0.5	±1	%
			±3	±6	%
switching frequency	PWM mode		300		kHz
transient recovery time	25% load step change, nominal input voltage		300	500	μs
transient response deviation	25% load step change, nominal input voltage		±5	±8	%
temperature coefficient	at full load			±0.03	%/°C

## PROTECTIONS

parameter	conditions/description	min	typ	max	units
over voltage protection		110		160	%Vo
over current protection		110	150	200	%
short circuit protection	continuous, self recovery				
input under voltage protection		12	15.5		Vdc

## SAFETY AND COMPLIANCE

parameter	conditions/description	min	typ	max	units
isolation voltage	input to output for 1 minute at 1 mA output to output for 1 minute at 1 mA	1,500 500			Vdc Vdc
isolation resistance	input to output at 500 Vdc	1,000			MΩ
isolation capacitance	input to output, 100 kHz / 0.1 V		1,000		pF
safety approvals	EN/IEC 62368				
EMI/EMC	EN 55032: 2015 Class B, EN 55024: 2010+A1: 2015 (see recommended circuit)				
ESD	IEC/EN61000-4-2, Contact ±4KV / Air ±6KV, perf. Criteria B				
radiated immunity	IEC/EN61000-4-3, 10V/m, perf. Criteria A				
EFT/burst	IEC/EN61000-4-4, ±2KV (see recommended circuit), perf. Criteria B				
surge	IEC/EN61000-4-5, line to line ±2KV (see recommended circuit), perf. Criteria B				
conducted immunity	IEC/EN61000-4-6, 10 Vr.m.s, perf. Criteria A				
MTBF	as per MIL-HDBK-217F, 25°C	1000			K hours
RoHS	yes				

## ENVIRONMENTAL

parameter	conditions/description	min	typ	max	units
operating temperature	see derating curve	-40		85	°C
storage temperature		-55		125	°C
storage humidity	non-condensing	5		95	%
vibration	10-150Hz		5		G

## MECHANICAL

parameter	conditions/description	min	typ	max	units
dimensions	25.40 x 25.40 x 11.70 [1.000 x 1.000 x 0.461 inch]				mm
case material	aluminum alloy				
weight			13		g

## MECHANICAL DRAWING

units: mm [inch]  
 tolerance:  $\pm 0.50$  [ $\pm 0.020$ ]  
 pin diameter tolerance:  $\pm 0.10$  [ $\pm 0.004$ ]

PIN Out	
PIN	Function
1	Ctrl
2	GND
3	Vin
4	+Vo2
5	0V2
6	0V1
7	+Vo1

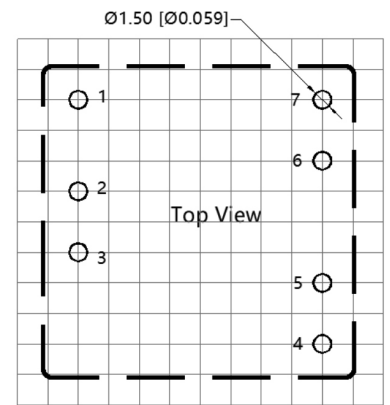
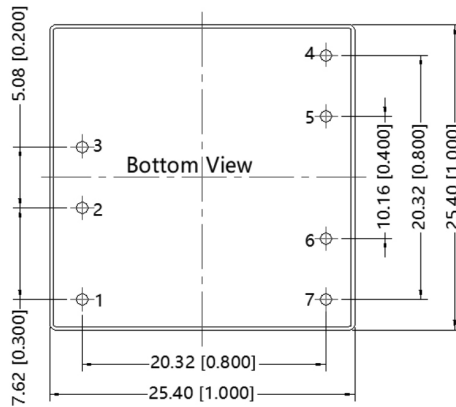
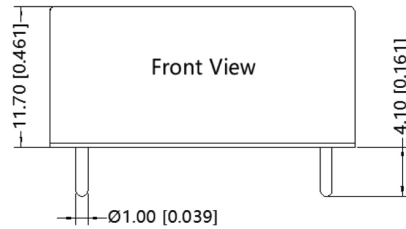

Note: Grid 2.54\*2.54mm

## DERATING CURVE

### TEMPERATURE DERATING CURVE

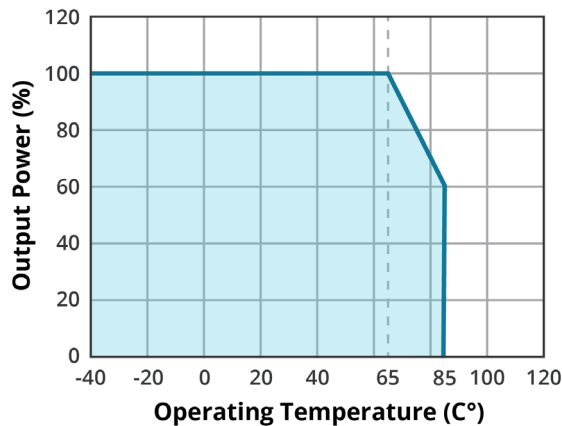

## APPLICATION CIRCUIT

All the DC-DC converters of this series are tested before delivery using the recommended circuit shown in Fig. 2. Input and/or output ripple can be further reduced by appropriately increasing the input & output capacitor values  $C_{in}$  and  $C_{out}$  and/or by selecting capacitors with a low ESR (equivalent series resistance). Also make sure that the capacitance is not exceeding the max. capacitive load value of the product.

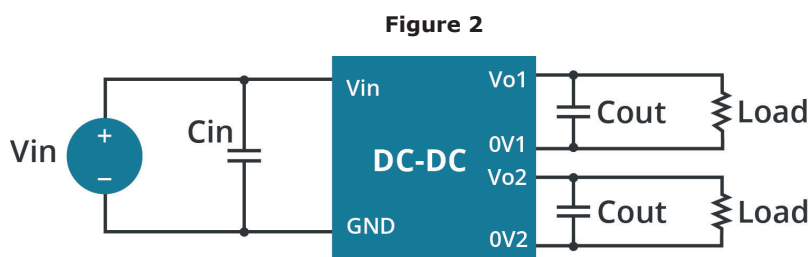

**Table 1**

Vout (Vdc)	Cin ( $\mu$ F)	Cout ( $\mu$ F)
5	100	100
12	100	22
24	100	22

## EMC RECOMMENDED CIRCUIT

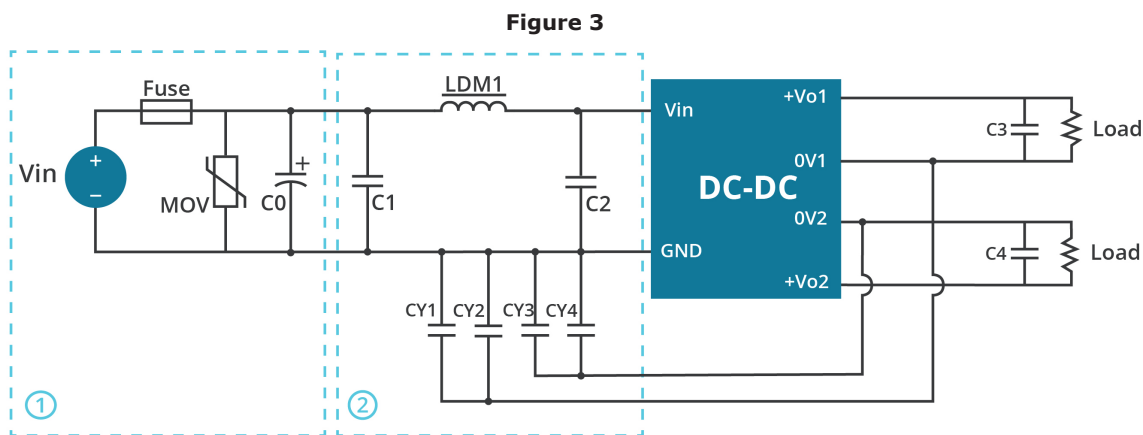

**Table 2**

Recommended External Circuit Components	
Model	Vin: 48V
FUSE	Choose according to actual input current
MOV	S14K60
C0	330 $\mu$ F/100V
C1/C2	4.7 $\mu$ F/100V
C3/C4	Refer to the Cout in Fig.2
LDM1	15uH
CY1, CY2, CY3, CY4	2.2nF/2000V

## REVISION HISTORY

---

rev.	description	date
1.0	initial release	06/29/2020
1.01	derating curve and circuit figures updated	07/22/2021

The revision history provided is for informational purposes only and is believed to be accurate.



**Headquarters**  
20050 SW 112th Ave.  
Tualatin, OR 97062  
**800.275.4899**

Fax 503.612.2383  
**cui.com**  
techsupport@cui.com

CUI offers a two (2) year limited warranty. Complete warranty information is listed on our website.

CUI reserves the right to make changes to the product at any time without notice. Information provided by CUI is believed to be accurate and reliable. However, no responsibility is assumed by CUI for its use, nor for any infringements of patents or other rights of third parties which may result from its use.

CUI products are not authorized or warranted for use as critical components in equipment that requires an extremely high level of reliability. A critical component is any component of a life support device or system whose failure to perform can be reasonably expected to cause the failure of the life support device or system, or to affect its safety or effectiveness.