

Automotive rail-to-rail 1.8 V high-speed comparator

Datasheet - production data

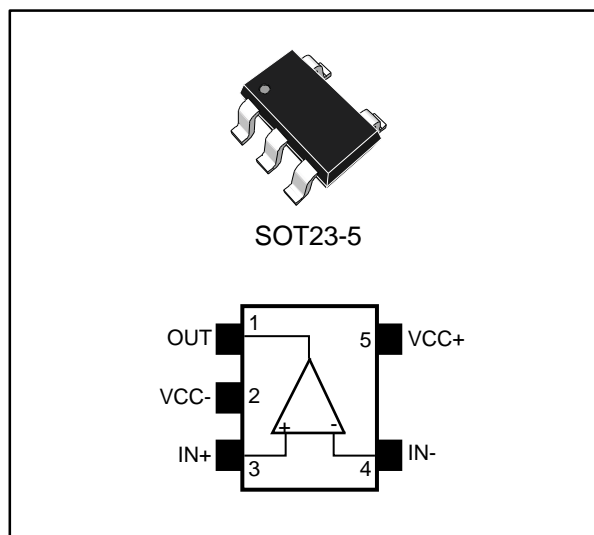

Features

- AEC-Q100 and Q003 qualified
- Extended temperature range: -40 °C to 150 °C
- Propagation delay: 38 ns
- Low current consumption: 73 µA
- Rail-to-rail inputs
- Push-pull outputs
- Supply operation from 1.8 to 5 V
- High ESD tolerance: 5 kV HBM, 300 V MM
- Latch-up immunity: 200 mA
- SMD package



Related products

- TS3021 for standard temperature range (-40 °C to 125 °C)

Applications

- Automotive
- Telecom
- Instrumentation
- Signal conditioning
- High-speed sampling systems
- Portable communication systems

Description

The TS3021H single comparator features high-speed response time with rail-to-rail inputs. With a supply voltage specified from 2 to 5 V, this comparator can operate over a wide temperature range: -40 °C to 150 °C.

The TS3021H comparator offers micropower consumption as low as a few tens of microamperes thus providing an excellent ratio of power consumption current versus response time.

The TS3021H includes push-pull outputs and is available in the small SOT23-5 package.

Contents

1	Absolute maximum ratings and operating conditions	3
2	Electrical characteristics	4
3	Package information	15
	3.1 SOT23-5 package information	16
4	Ordering information.....	17
5	Revision history	18

1 Absolute maximum ratings and operating conditions

Table 1: Absolute maximum ratings (AMR)

Symbol	Parameter	Value	Unit
V _{CC}	Supply voltage, V _{CC} = (V _{CC+}) - (V _{CC-}) ⁽¹⁾	5.5	V
V _{ID}	Differential input voltage ⁽²⁾	±5	
V _{IN}	Input voltage range	(V _{CC-}) - 0.3 to (V _{CC+}) + 0.3	
I _{IN}	Input current ⁽³⁾	10	mA
R _{thja}	Thermal resistance junction-to-ambient ⁽⁴⁾	250	°C/W
R _{thjc}	Thermal resistance junction-to-case ⁽⁴⁾	81	
T _{stg}	Storage temperature	-65 to 160	°C
T _j	Junction temperature	160	
T _{LEAD}	Lead temperature (soldering 10 s)	260	
ESD	HBM: human body model ⁽⁵⁾	5000	V
	CDM: charged device model ⁽⁶⁾	1500	
	Latch-up immunity	200	mA

Notes:

⁽¹⁾All voltage values, except the differential voltage, are referenced to (V_{CC-})

⁽²⁾The magnitude of the input and output voltages must never exceed the supply rail ±0.3 V

⁽³⁾The input current must be limited by a resistor in series with the inputs.

⁽⁴⁾Short circuits can cause excessive heating. These values are typical

⁽⁵⁾Human body model: a 100 pF capacitor is charged to the specified voltage, then discharged through a 1.5 kΩ resistor between two pins of the device. This is done for all couples of connected pin combinations while the other pins are floating.

⁽⁶⁾Charged device model: all pins and the package are charged together to the specified voltage and then discharged directly to the ground through only one pin. This is done for all pins.

Table 2: Operating conditions

Symbol	Parameter	Value	Unit	
V _{CC}	Supply voltage	0 °C < Tamb < 150 °C	1.8 to 5	V
		-40 °C < Tamb < 150 °C	2 to 5	
V _{icm}	Common-mode input voltage range	-40 °C < Tamb < 85 °C	(V _{CC-}) - 0.2 to (V _{CC+}) + 0.2	
		85 °C < Tamb < 150 °C	(V _{CC-}) to (V _{CC+})	
T _{oper}	Operating temperature range	-40 to 150	°C	

2 Electrical characteristics

Table 3: Electrical characteristics at VCC = 2 V, Tamb = 25 °C, and full Vicm range (unless otherwise specified)

Symbol	Parameter	Test conditions ⁽¹⁾	Min.	Typ.	Max.	Unit
V _{IO}	Input offset voltage	Tamb		0.5	6	mV
		-40 °C < Tamb < 150 °C		0.5	7	
ΔV _{IO} /ΔT	Input offset voltage drift	-40 °C < Tamb < 150 °C		3	20	μV/°C
I _{IO}	Input offset current ⁽²⁾	Tamb		1	20	nA
		-40 °C < Tamb < 150 °C			100	
I _B	Input bias current ⁽²⁾	Tamb		86	160	nA
		-40 °C < Tamb < 150 °C			300	
I _{CC}	Supply current	No load, output high, Vicm = 0 V		73	90	μA
		No load, output high, Vicm = 0 V, -40 °C < Tamb < 150 °C			115	
		No load, output low, Vicm = 0 V		84	105	
		No load, output low, Vicm = 0 V, -40 °C < Tamb < 150 °C			125	
I _{SC}	Short-circuit current	Source		9		mA
		Sink		10		
V _{OH}	Output voltage high	I _{source} = 1 mA	1.88	1.92		V
		-40 °C < Tamb < 150 °C	1.79			
V _{OL}	Output voltage low	I _{sink} = 1 mA		60	100	mV
		-40 °C < Tamb < 150 °C			170	
CMRR	Common-mode rejection ratio	0 < Vicm < 2 V		67		dB
SVR	Supply voltage rejection	ΔV _{CC} = 2 to 5 V, Vicm = 0 V	58	73		
T _{PLH}	Propagation delay, low to high output level ⁽³⁾	Vicm = 0 V, f = 10 kHz, CL = 50 pF, overdrive = 100 mV		38	60	ns
		Vicm = 0 V, f = 10 kHz, CL = 50 pF, overdrive = 100 mV, -40 °C < Tamb < 150 °C			120	
		Vicm = 0 V, f = 10 kHz, CL = 50 pF, overdrive = 20 mV		48	75	
		Vicm = 0 V, f = 10 kHz, CL = 50 pF, overdrive = 20 mV, -40 °C < Tamb < 150 °C			140	

Symbol	Parameter	Test conditions ⁽¹⁾	Min.	Typ.	Max.	Unit
T _{PHL}	Propagation delay, high to low output level ⁽⁴⁾	V _{icm} = 0 V, f = 10 kHz, CL = 50 pF, overdrive = 100 mV		40	60	ns
		V _{icm} = 0 V, f = 10 kHz, CL = 50 pF, overdrive = 100 mV, -40 °C < T _{amb} < 150 °C			120	
		V _{icm} = 0 V, f = 10 kHz, CL = 50 pF, overdrive = 20 mV		49	75	
		V _{icm} = 0 V, f = 10 kHz, CL = 50 pF, overdrive = 20 mV, -40 °C < T _{amb} < 150 °C			140	
T _F	Fall time	f = 10 kHz, CL = 50 pF, RL = 10 kΩ, overdrive = 100 mV		8		
T _R	Rise time	f = 10 kHz, CL = 50 pF, RL = 10 kΩ, overdrive = 100 mV		9		

Notes:

⁽¹⁾All values over the temperature range are guaranteed through correlation and simulation. No production test is performed at the temperature range limits.

⁽²⁾Maximum values include unavoidable inaccuracies of the industrial tests.

⁽³⁾Response time is measured 10%/90% of the final output value with the following conditions: inverting input voltage (IN-) = V_{icm} and non-inverting input voltage (IN+) moving from V_{icm} - 100 mV to V_{icm} + overdrive.

⁽⁴⁾Response time is measured 10%/90% of the final output value with the following conditions: Inverting input voltage (IN-) = V_{icm} and non-inverting input voltage (IN+) moving from V_{icm} + 100 mV to V_{icm} - overdrive.

Table 4: Electrical characteristics at VCC = 3.3 V, Tamb = 25 ° C, and full Vicm range (unless otherwise specified)

Symbol	Parameter	Test conditions ⁽¹⁾	Min.	Typ.	Max.	Unit
V _{IO}	Input offset voltage	Tamb		0.2	6	mV
		-40 °C < Tamb < 150 °C		0.2	7	
$\Delta V_{IO}/\Delta T$	Input offset voltage drift	-40 °C < Tamb < 150 °C		3	20	$\mu V/^\circ C$
I _{IO}	Input offset current ⁽²⁾	Tamb		1	20	nA
		-40 °C < Tamb < 150 °C			100	
I _{IB}	Input bias current ⁽²⁾	Tamb		86	160	nA
		-40 °C < Tamb < 150 °C			300	
I _{CC}	Supply current	No load, output high, Vicm = 0 V		75	90	μA
		No load, output high, Vicm = 0 V, -40 °C < Tamb < 150 °C			120	
		No load, output low, Vicm = 0 V		86	110	
		No load, output low, Vicm = 0 V, -40 °C < Tamb < 150 °C			125	
I _{SC}	Short-circuit current	Source		26		mA
		Sink		24		
V _{OH}	Output voltage high	I _{source} = 1 mA	3.20	3.25		V
		-40 °C < Tamb < 150 °C	3.16			
V _{OL}	Output voltage low	I _{sink} = 1 mA		40	80	mV
		-40 °C < Tamb < 150 °C			120	
CMRR	Common-mode rejection ratio	0 < Vicm < 3.3 V		75		dB
SVR	Supply voltage rejection	$\Delta V_{CC} = 2$ to 5 V, Vicm = 0 V	58	73		
T _{PLH}	Propagation delay, low to high output level ⁽³⁾	Vicm = 0 V, f = 10 kHz, CL = 50 pF, overdrive = 100 mV		39	65	ns
		Vicm = 0 V, f = 10 kHz, CL = 50 pF, overdrive = 100 mV, -40 °C < Tamb < 150 °C			115	
		Vicm = 0 V, f = 10 kHz, CL = 50 pF, overdrive = 20 mV		50	85	
		Vicm = 0 V, f = 10 kHz, CL = 50 pF, overdrive = 20 mV, -40 °C < Tamb < 150 °C			145	

Symbol	Parameter	Test conditions ⁽¹⁾	Min.	Typ.	Max.	Unit
T _{PHL}	Propagation delay, high to low output level ⁽⁴⁾	V _{icm} = 0 V, f = 10 kHz, CL = 50 pF, overdrive = 100 mV		41	65	ns
		V _{icm} = 0 V, f = 10 kHz, CL = 50 pF, overdrive = 100 mV, -40 °C < T _{amb} < 150 °C			115	
		V _{icm} = 0 V, f = 10 kHz, CL = 50 pF, overdrive = 20 mV		51	80	
		V _{icm} = 0 V, f = 10 kHz, CL = 50 pF, overdrive = 20 mV, -40 °C < T _{amb} < 150 °C			145	
T _F	Fall time	f = 10 kHz, CL = 50 pF, RL = 10 kΩ, overdrive = 100 mV		5		
T _R	Rise time	f = 10 kHz, CL = 50 pF, RL = 10 kΩ, overdrive = 100 mV		7		

Notes:

⁽¹⁾All values over the temperature range are guaranteed through correlation and simulation. No production test is performed at the temperature range limits.

⁽²⁾Maximum values include unavoidable inaccuracies of the industrial tests

⁽³⁾Response time is measured 10%/90% of the final output value with the following conditions: inverting input voltage (IN-) = V_{icm} and non-inverting input voltage (IN+) moving from V_{icm} - 100 mV to V_{icm} + overdrive.

⁽⁴⁾Response time is measured 10%/90% of the final output value with the following conditions: Inverting input voltage (IN-) = V_{icm} and non-inverting input voltage (IN+) moving from V_{icm} + 100 mV to V_{icm} - overdrive.

Table 5: Electrical characteristics at VCC = 5 V, Tamb = 25 °C, and full Vicm range (unless otherwise specified)

Symbol	Parameter	Test conditions ⁽¹⁾	Min.	Typ.	Max.	Unit
V _{IO}	Input offset voltage	Tamb		0.2	6	mV
		-40 °C < Tamb < 150 °C		0.2	7	
$\Delta V_{IO}/\Delta T$	Input offset voltage drift	-40 °C < Tamb < 150 °C		3	20	$\mu V/^{\circ}C$
I _{IO}	Input offset current ⁽²⁾	Tamb		1	20	nA
		-40 °C < Tamb < 150 °C			100	
I _{IB}	Input bias current ⁽²⁾	Tamb		86	160	
		-40 °C < Tamb < 150 °C			300	
I _{CC}	Supply current	No load, output high, Vicm = 0 V		77	95	μA
		No load, output high, Vicm = 0 V, -40 °C < Tamb < 150 °C			125	
		No load, output low, Vicm = 0 V		89	115	
		No load, output low, Vicm = 0 V, -40 °C < Tamb < 150 °C			135	
I _{SC}	Short-circuit current	Source		51		mA
		Sink		40		
V _{OH}	Output voltage high	I _{source} = 4 mA	4.80	4.84		V
		-40 °C < Tamb < 150 °C	4.68			
V _{OL}	Output voltage low	I _{sink} = 4 mA		130	180	mV
		-40 °C < Tamb < 150 °C			270	
CMRR	Common-mode rejection ratio	0 < Vicm < 5 V		79		dB
SVR	Supply voltage rejection	$\Delta V_{CC} = 2$ to 5 V, Vicm = 0 V	58	73		
T _{PLH}	Propagation delay, low to high output level ⁽³⁾	Vicm = 0 V, f = 10 kHz, CL = 50 pF, overdrive = 100 mV		42	75	ns
		Vicm = 0 V, f = 10 kHz, CL = 50 pF, overdrive = 100 mV, -40 °C < Tamb < 150 °C			120	
		Vicm = 0 V, f = 10 kHz, CL = 50 pF, overdrive = 20 mV		54	105	
		Vicm = 0 V, f = 10 kHz, CL = 50 pF, overdrive = 20 mV, -40 °C < Tamb < 150 °C			150	

Symbol	Parameter	Test conditions ⁽¹⁾	Min.	Typ.	Max.	Unit
T _{PHL}	Propagation delay, high to low output level ⁽⁴⁾	V _{icm} = 0 V, f = 10 kHz, CL = 50 pF, overdrive = 100 mV		45	75	ns
		V _{icm} = 0 V, f = 10 kHz, CL = 50 pF, overdrive = 100 mV, -40 °C < T _{amb} < 150 °C			120	
		V _{icm} = 0 V, f = 10 kHz, CL = 50 pF, overdrive = 20 mV		55	95	
		V _{icm} = 0 V, f = 10 kHz, CL = 50 pF, overdrive = 20 mV, -40 °C < T _{amb} < 150 °C			150	
T _F	Fall time	f = 10 kHz, CL = 50 pF, RL = 10 kΩ, overdrive = 100 mV		4		
T _R	Rise time	f = 10 kHz, CL = 50 pF, RL = 10 kΩ, overdrive = 100 mV		4		

Notes:

⁽¹⁾All values over the temperature range are guaranteed through correlation and simulation. No production test is performed at the temperature range limits.

⁽²⁾Maximum values include unavoidable inaccuracies of the industrial tests

⁽³⁾Response time is measured 10%/90% of the final output value with the following conditions: inverting input voltage (IN-) = V_{icm} and non-inverting input voltage (IN+) moving from V_{icm} - 100 mV to V_{icm} + overdrive.

⁽⁴⁾Response time is measured 10%/90% of the final output value with the following conditions: Inverting input voltage (IN-) = V_{icm} and non-inverting input voltage (IN+) moving from V_{icm} + 100 mV to V_{icm} - overdrive.

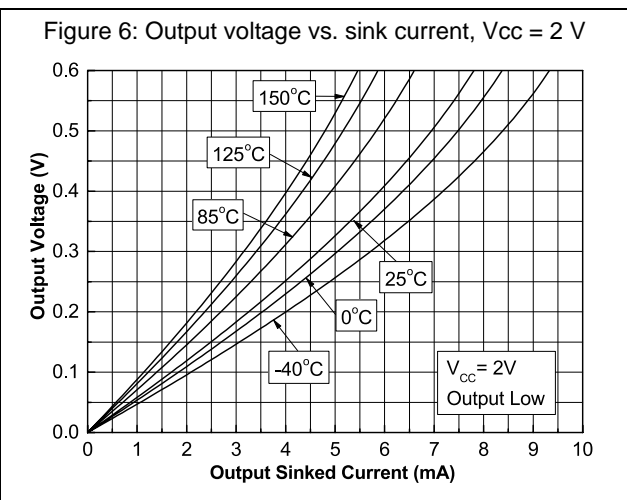
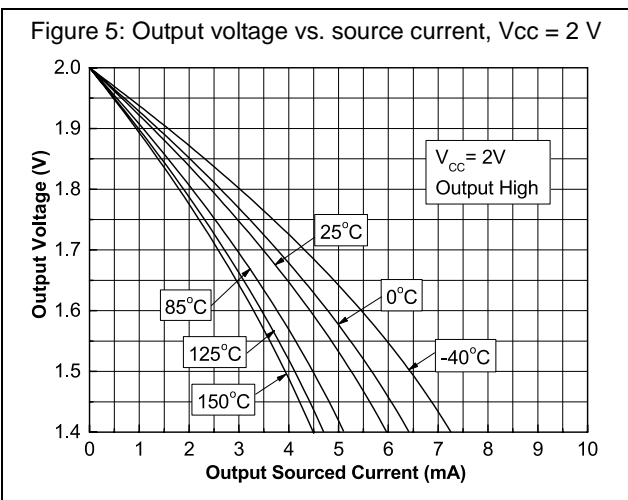
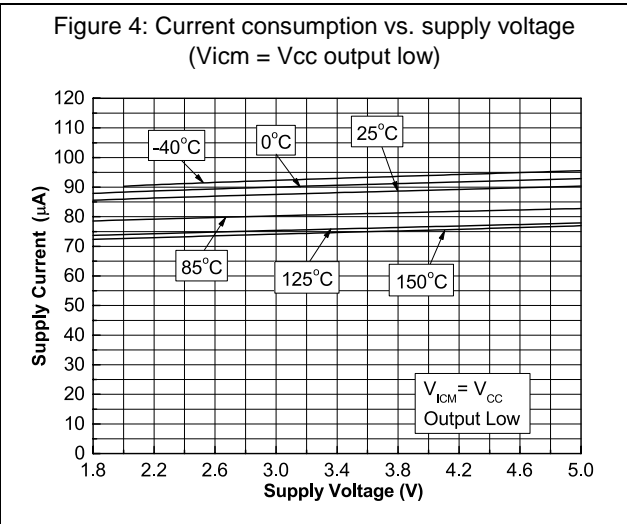
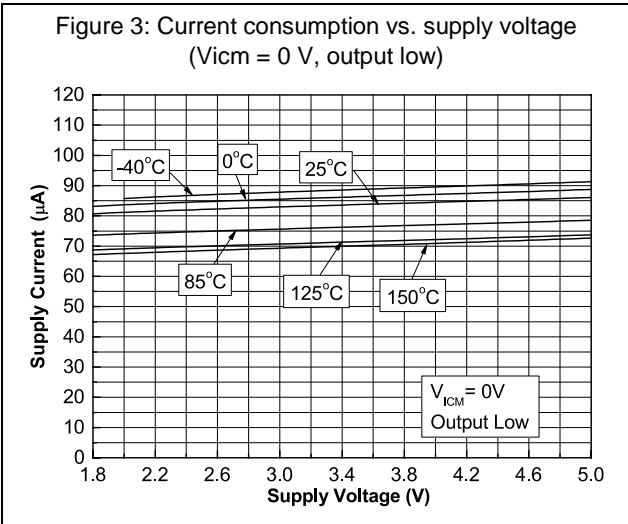
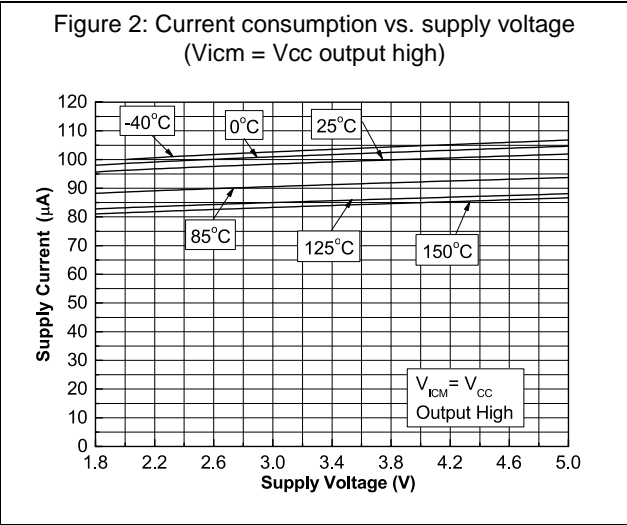
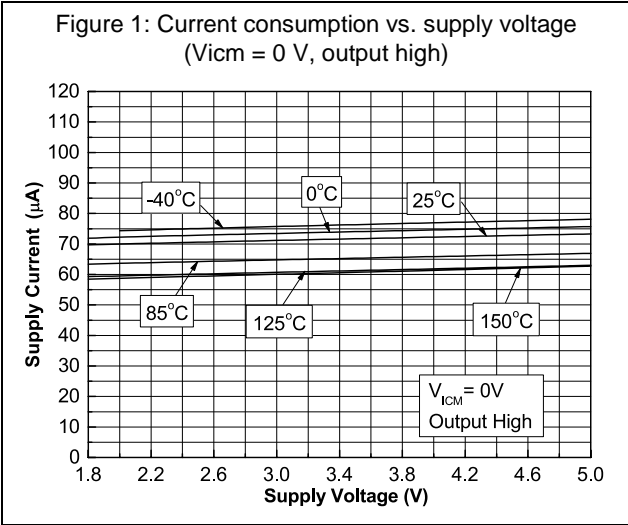

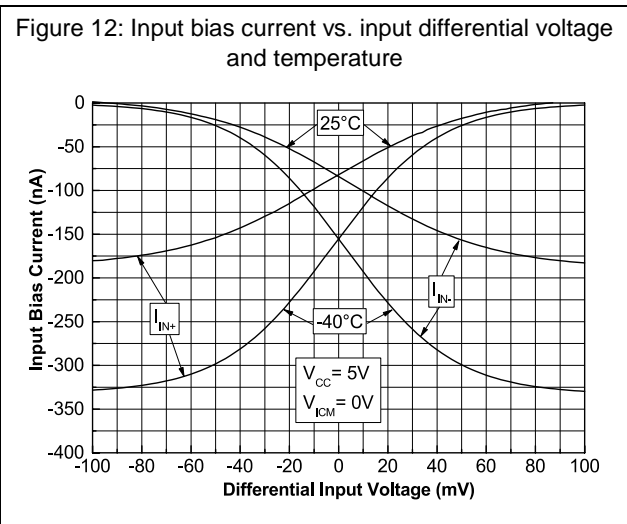
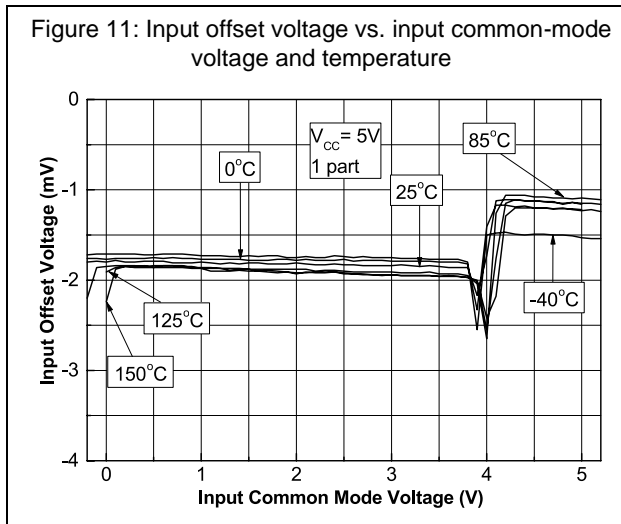
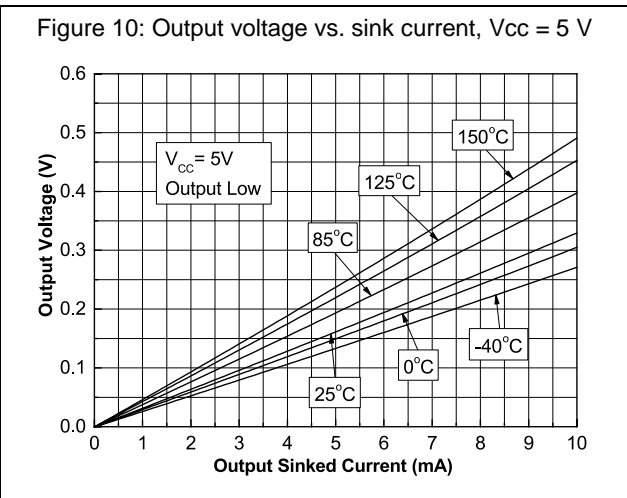
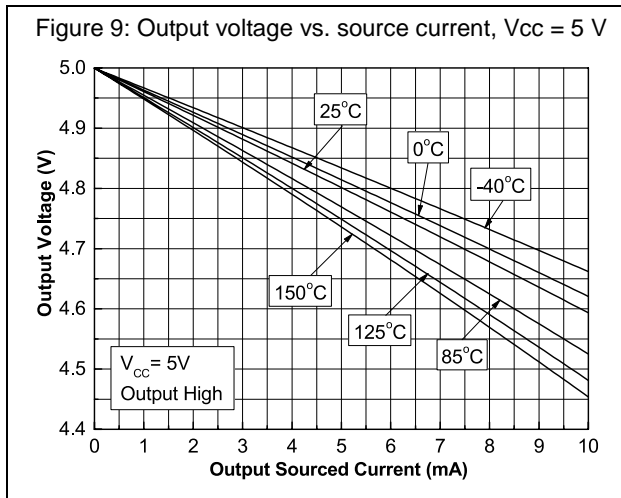
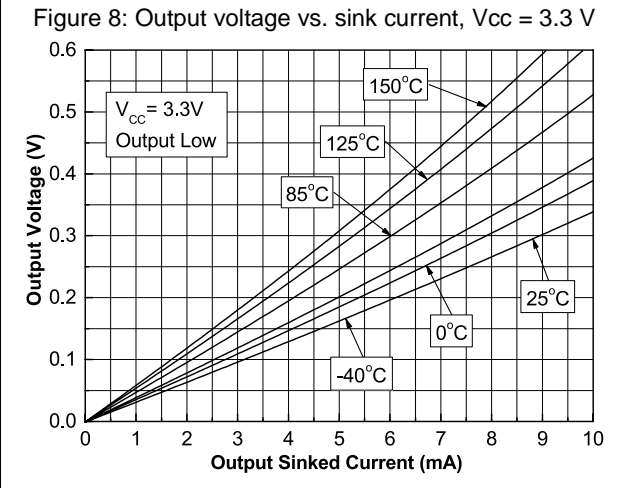
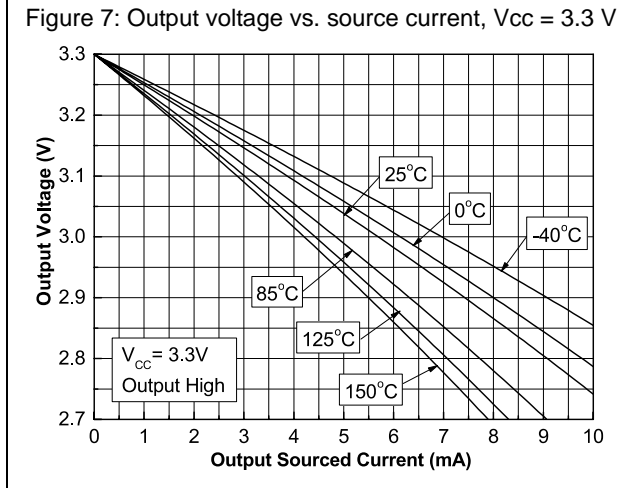

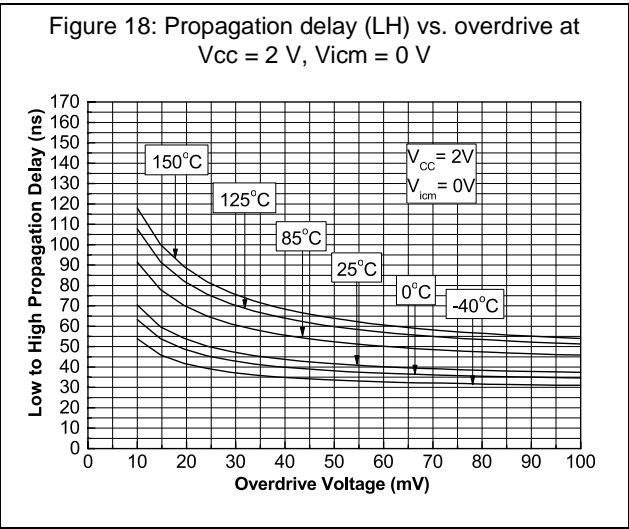
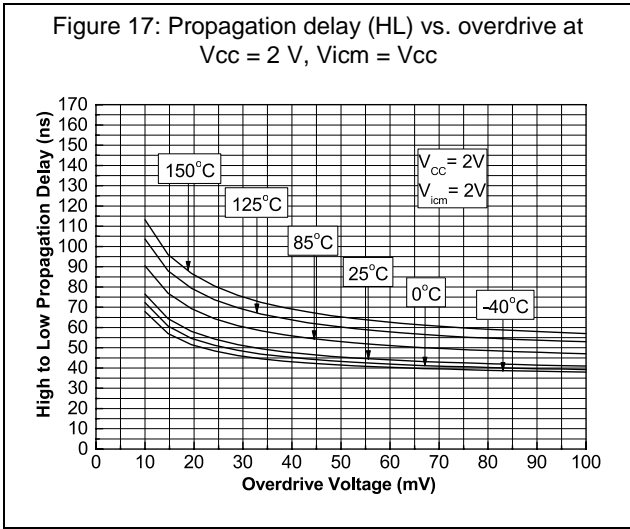
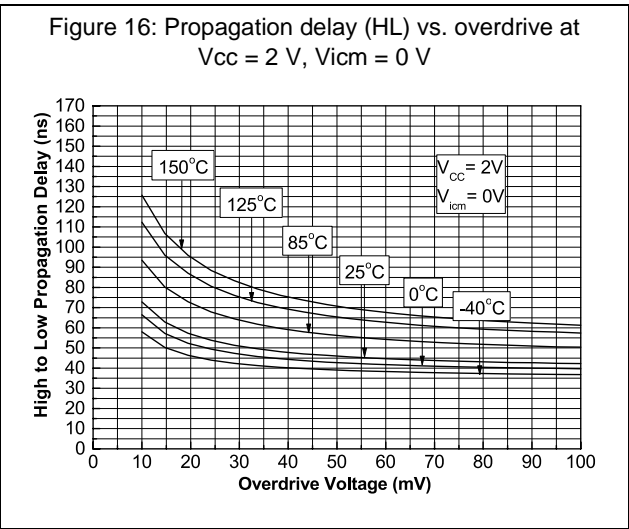
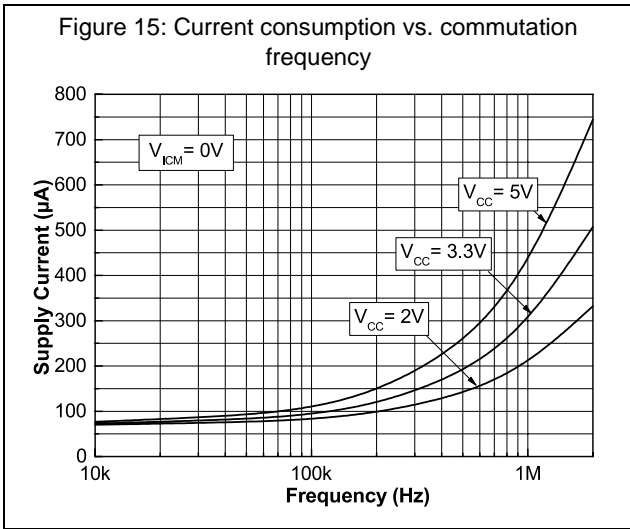
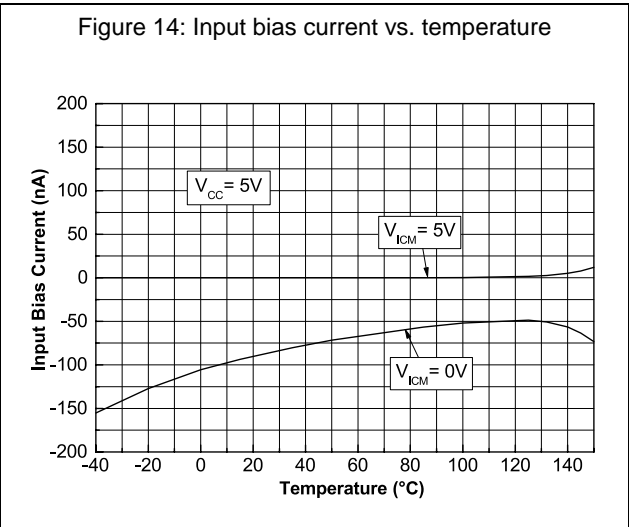
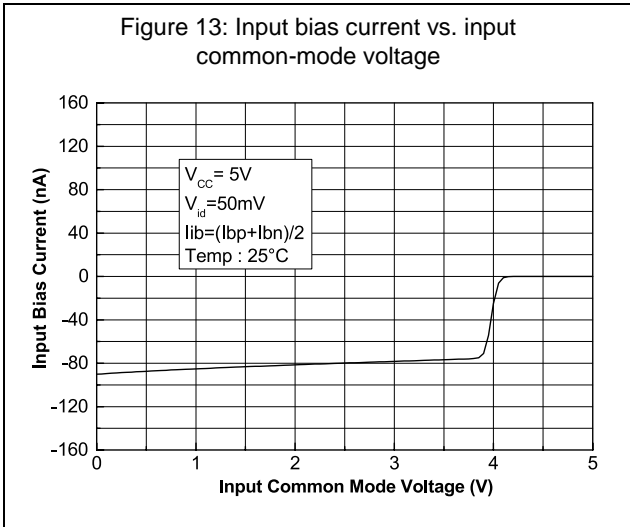

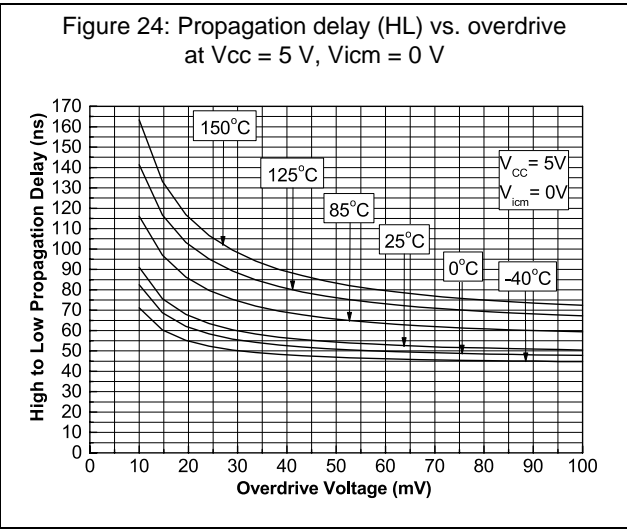
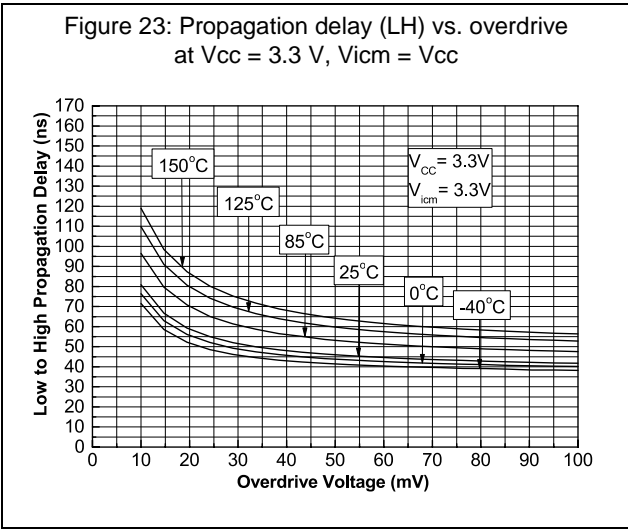
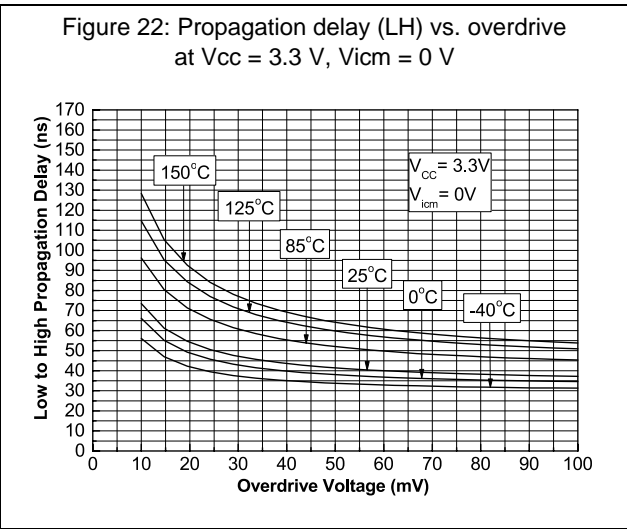
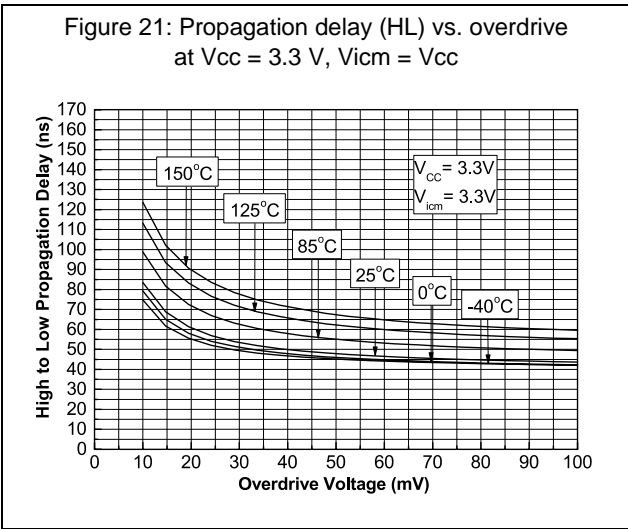
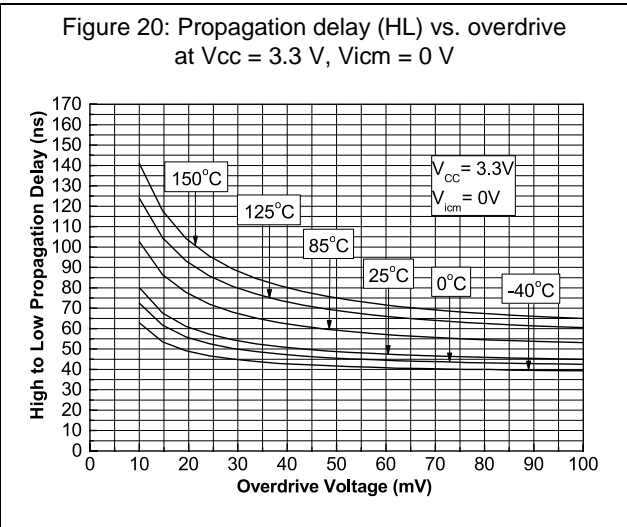
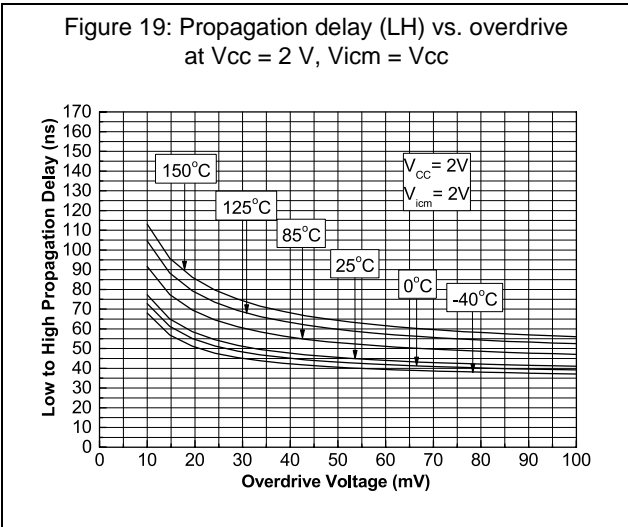

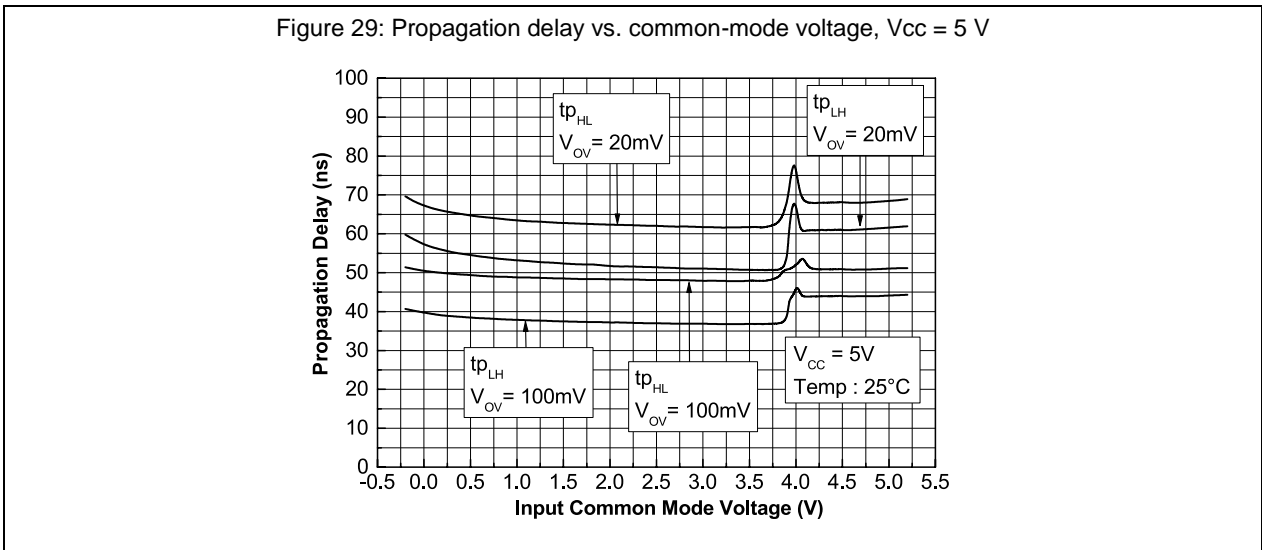
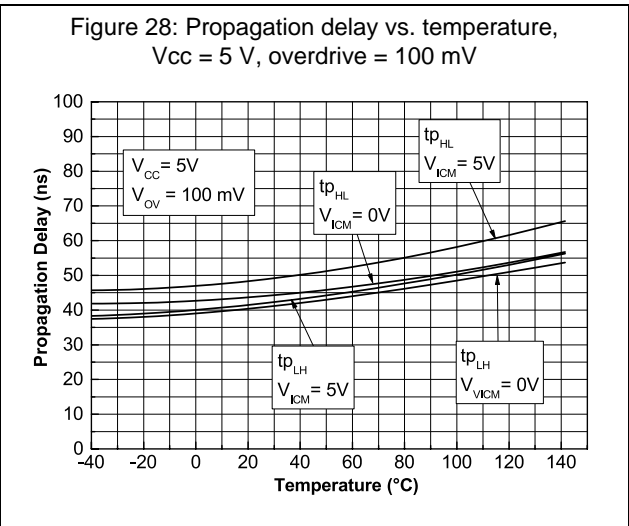
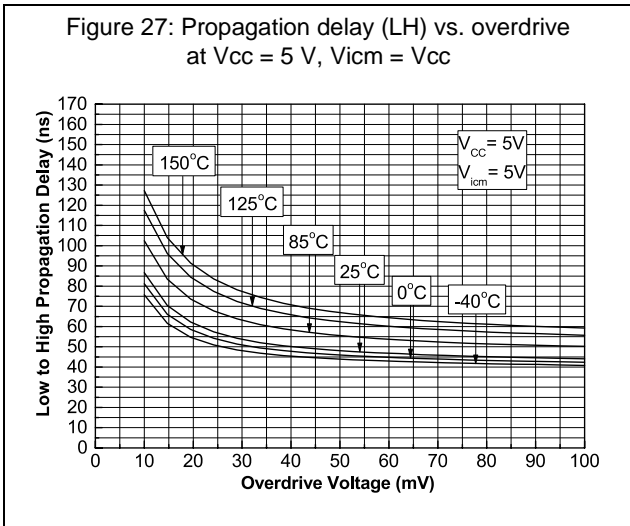
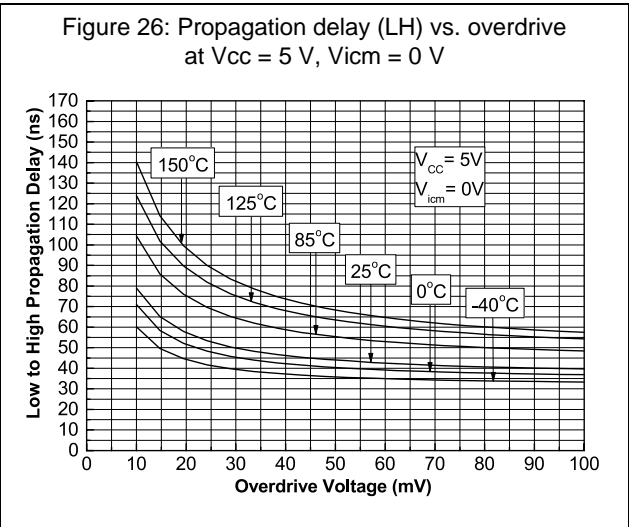
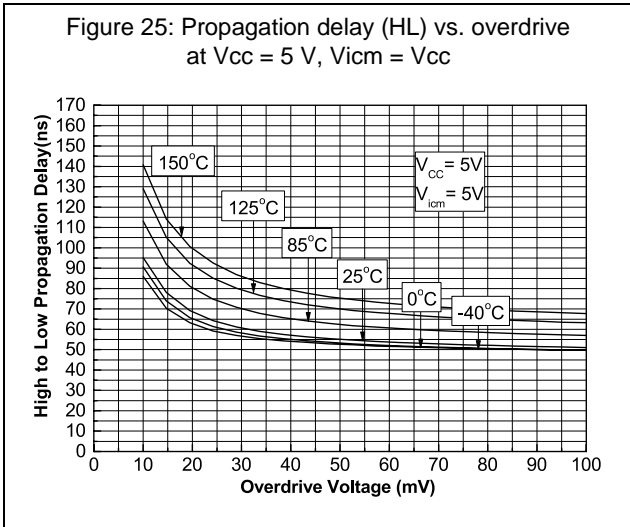

3 Package information

In order to meet environmental requirements, ST offers these devices in different grades of ECOPACK® packages, depending on their level of environmental compliance. ECOPACK® specifications, grade definitions and product status are available at: www.st.com. ECOPACK® is an ST trademark.

3.1 SOT23-5 package information

Figure 30: SOT23-5 package outline

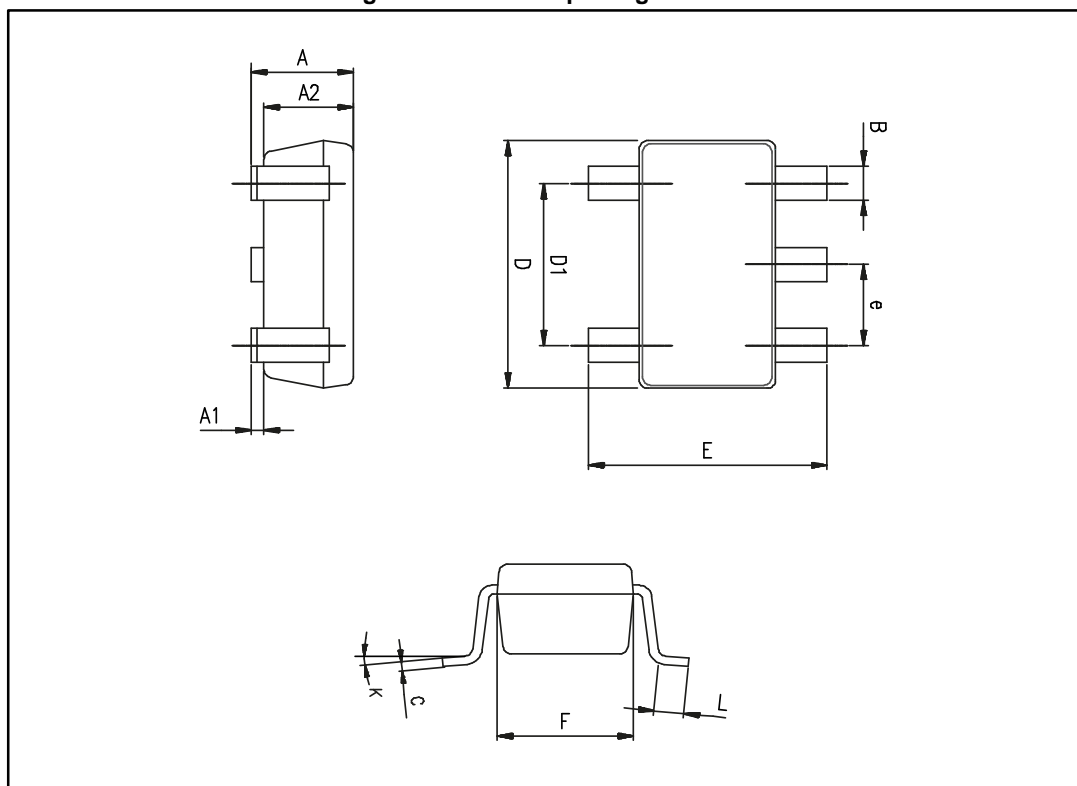

Table 6: SOT23-5 mechanical data

Ref.	Dimensions					
	Millimeters			Inches		
	Min.	Typ.	Max.	Min.	Typ.	Max.
A	0.90	1.20	1.45	0.035	0.047	0.057
A1			0.15			0.006
A2	0.90	1.05	1.30	0.035	0.041	0.051
B	0.35	0.40	0.50	0.014	0.016	0.020
C	0.09	0.15	0.20	0.004	0.006	0.008
D	2.80	2.90	3.00	0.110	0.114	0.118
D1		1.90			0.075	
e		0.95			0.037	
E	2.60	2.80	3.00	0.102	0.110	0.118
F	1.50	1.60	1.75	0.059	0.063	0.069
L	0.10	0.35	0.60	0.004	0.014	0.024
K	0 degrees		10 degrees	0 degrees		10 degrees

4 Ordering information

Table 7: Order codes

Order code	Temperature range	Package	Packaging	Marking
TS3021HIYLT ⁽¹⁾	-40 to 150 °C	SOT23-5	Tape and reel	K528

Notes:

⁽¹⁾Qualified and characterized according to AEC-Q100 and Q003 or equivalent, advanced screening according to AEC-Q001 and Q 002 or equivalent.

5 Revision history

Table 8: Document revision history

Date	Version	Changes
13-Oct-2015	1	Initial release
24-Aug-2016	2	Updated document title (automotive qualified) Added AEC-Q100 and Q003 qualified in Features section <i>Table 1: "Absolute maximum ratings (AMR)":</i> removed ESD MM value. <i>Table 7: "Order codes":</i> updated footnote, product is now automotive qualified.

IMPORTANT NOTICE – PLEASE READ CAREFULLY

STMicroelectronics NV and its subsidiaries ("ST") reserve the right to make changes, corrections, enhancements, modifications, and improvements to ST products and/or to this document at any time without notice. Purchasers should obtain the latest relevant information on ST products before placing orders. ST products are sold pursuant to ST's terms and conditions of sale in place at the time of order acknowledgement.

Purchasers are solely responsible for the choice, selection, and use of ST products and ST assumes no liability for application assistance or the design of Purchasers' products.

No license, express or implied, to any intellectual property right is granted by ST herein.

Resale of ST products with provisions different from the information set forth herein shall void any warranty granted by ST for such product.

ST and the ST logo are trademarks of ST. All other product or service names are the property of their respective owners.

Information in this document supersedes and replaces information previously supplied in any prior versions of this document.

© 2016 STMicroelectronics – All rights reserved