

# Part No. LSP69001299TR

## LTE Cat-M1 / NB-IoT Antenna

700 / 750 / 850 / 900 / 1800 / 1900 / 2100 MHz

Supports: LTE Cat 1, LTE-M, SigFox, LoRa, NB-IoT, Cellular LPWA, RPMA, Broadband LTE (OCTA-BAND)

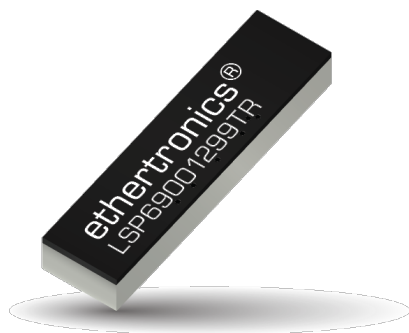

KYOCERA AVX' standard antennas provide high performance. They require a smaller design keep-out area, carry lower program development risk which yields a quicker time-to-market, without sacrificing RF performance.

### LTE Cat-M1/ NB IoT Antenna

Low Band 698 - 960 MHz  
High Band 1710 - 2170 MHz

#### KEY BENEFITS

##### Quicker Time-to-Market

Standard part means fewer design changes. Simple implementation, and Easy Assembly using RP-SMA or SMA

##### Best in Class Performance

Antennas are designed to maintain high efficiency in a variety of device configurations

##### Superior Network Coverage

Better network coverage means more reliable wireless connections

##### RoHS Compliant

Products are the latest RoHS version compliant.

#### APPLICATIONS

- IoT
- Healthcare
- Smart Metering
- Tracking
- M2M
- Industrial Devices
- Tracking
- SigFox
- LoRa
- Cellular
- LPWAN
- RPMA
- LTE Cat-M1

#### Extensive RF Experience

KYOCERA AVX antennas are supported by documentation, and when needed, by the expertise of RF engineers who have integrated hundreds of antenna designs into wireless devices.

#### Global Operations & Design Support

KYOCERA AVX' global operations support an integrated network of design centers that can take projects from concept to production.

#### Electrical Specifications

Typical performance antenna measured with 60 x 40 mm PCB

Frequency (MHz)	On 60x40 mm PCB	
	698 - 960	1710 - 2170
Return Loss	<-2.5 dB	<-3 dB
Efficiency	15 %	42 %
Peak Gain	<-2 dBi	<1.2 dBi
Impedance	50 ohms unbalanced	

#### Mechanical Specifications & Ordering Part Number

Ordering Part Number	LSP69001299TR
Dimensions (mm)	35.00 ± 0.10 length 9.00 ± 0.10 width 3.20 ± 0.10 thickness
Mechanical mounting	SMT (P&P)
Weight (grams)	0.2 grams
Color	Black

LTE Cat-M1 / NB-IoT antenna specifications  
 KYOCERA AVX produces a wide variety of standard and custom antennas to meet user needs

LTE Bands Covered by LSP69001299TR

LTE Band	Frequency Band (MHz)	Uplink (UL) (MHz)	Downlink (DL) (MHz)	Region	Covered with PCB
1	2100	1920 - 1980	2110 - 2170	Global	Yes
2	1900	1850 - 1910	1930 - 1990	NAM	
3	1800	1710 - 1785	1805 - 1880	Global	
4	1700	1710 - 1755	2110 - 2155	NAM	
5	850	824 - 849	869 - 894	NAM	
6	850	830 - 840	875 - 885	APAC	
7	2600	2500 - 2570	2620 - 2690	EMEA	No
8	900	880 - 915	925 - 960	Global	Yes
9	1800	1749.9 - 1784.9	1844.9 - 1879.9	APAC	No
10	1700	1710 - 1770	2110 - 2170	NAM	Yes
11	1500	1427.9 - 1447.9	1475.9 - 1495.9	Japan	No
12	700	699 - 716	729 - 746	NAM	yes
13	700	777 - 787	746 - 756	NAM	
14	700	788 - 798	758 - 768	NAM	
17	700	704 - 716	734 - 746	NAM	
18	850	815 - 830	860 - 875	Japan	Yes
19	850	830 - 845	875 - 890	Japan	
20	800	832 - 862	791 - 821	EMEA	No
21	1500	1447.9 - 1462.9	1495.9 - 1510.9	Japan	
22	3500	3410 - 3490	3510 - 3590	EMEA	Yes
23	2000	2000 - 2020	2180 - 2200	NAM	
24	1600	1626.5 - 1660.5	1525 - 1559	NAM	No
25	1900	1850 - 1915	1930 - 1995	NAM	Yes
26	850	814 - 849	859 - 894	NAM	
27	850	807 - 824	852 - 869	NAM	
28	700	703 - 748	758 - 803	APAC,EU	
29	700	N/A	717 - 728	NAM	
30	2300	2305 - 23151	2350 - 2360	NAM	
31	450	452.5 - 457.5	462.5 - 467.5	Global	No
32	1500	N/A	1452 - 1496	EMEA	Yes
33	1900		1900 - 1920		
34	2000		2010 - 2025		
35	1850		1850 - 1910		
36	1900		1930 - 1990		
37	1900		1910 - 1930		
38	2600		2570 - 2620		No
39	1900		1880 - 1920		Yes
40	2300		2300 - 2400		No
41	2500		2496 - 2690		
42	3500		3400 - 3600		
43	3700		3600 - 3800		

NAM: North America, EMEA: Europe, Middle East, and Africa, APAC: Asia-Pacific, EU: Europe

LTE Cat-M1 / NB-IoT antenna specifications  
 KYOCERA AVX produces a wide variety of standard and custom antennas to meet user needs

### Return loss and Efficiency Plots

Typical Performance measured with 60 x 40 mm PCB

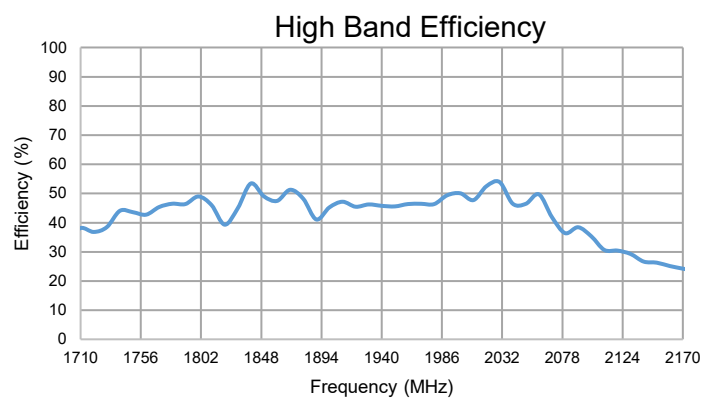
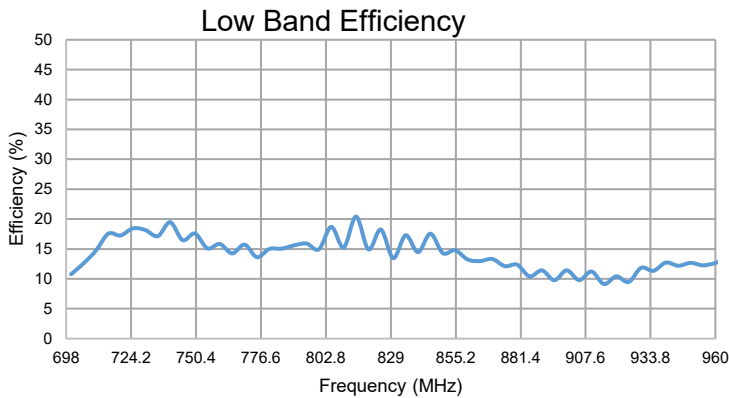
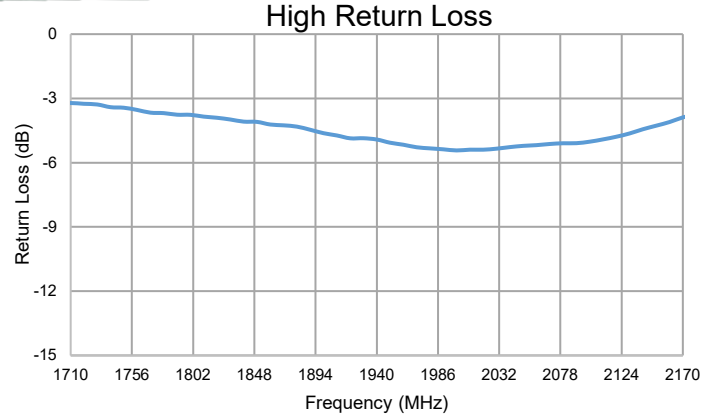
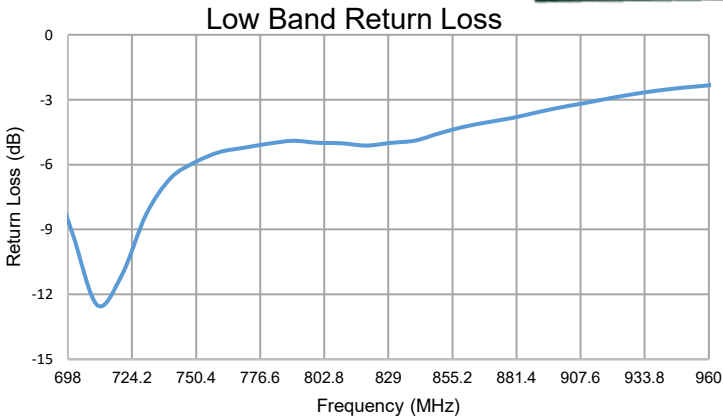

LTE Cat-M1 / NB-IoT antenna specifications  
 KYOCERA AVX produces a wide variety of standard and custom antennas to meet user needs

**Radiation pattern Plots**

Typical performance measured with 60 x 40 mm PCB  
 Measured at 700, 750, 850, 900, 1800, 1900, 2100 MHz

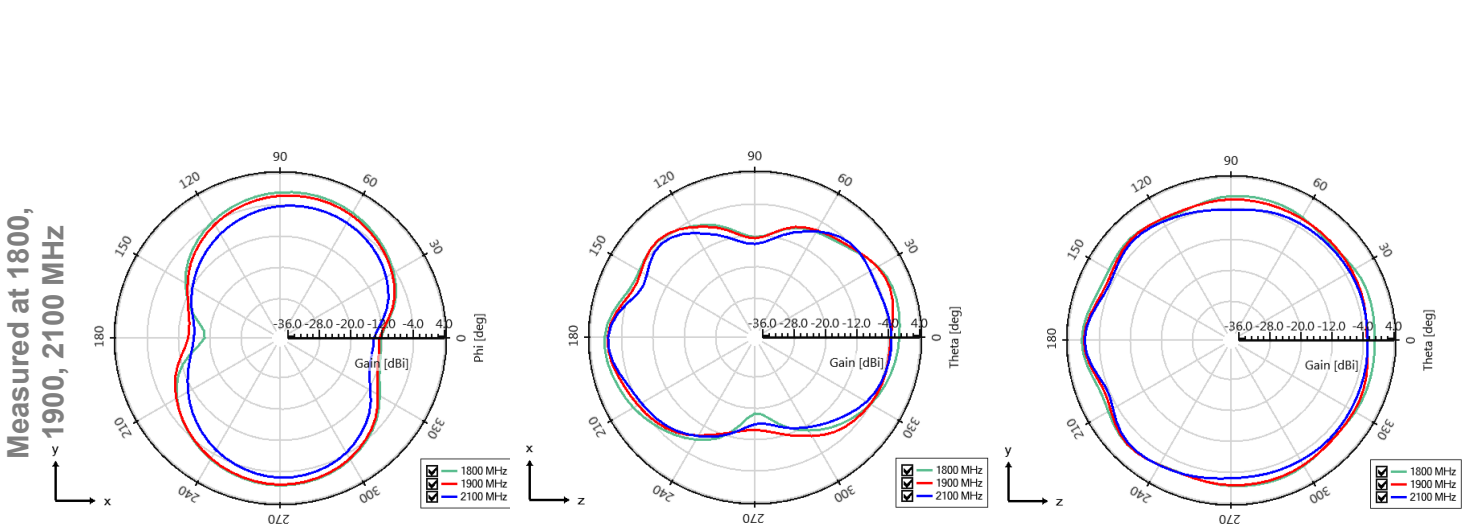
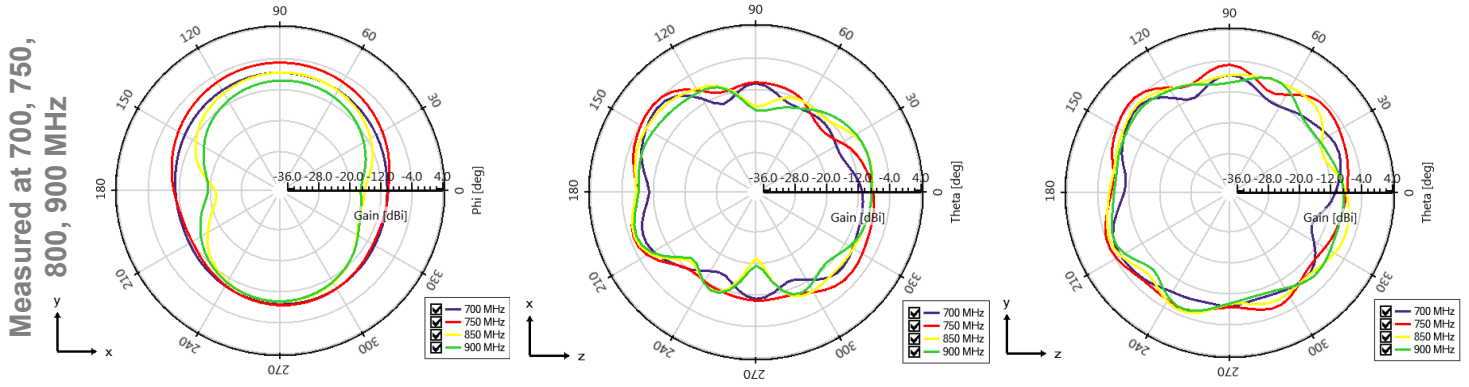
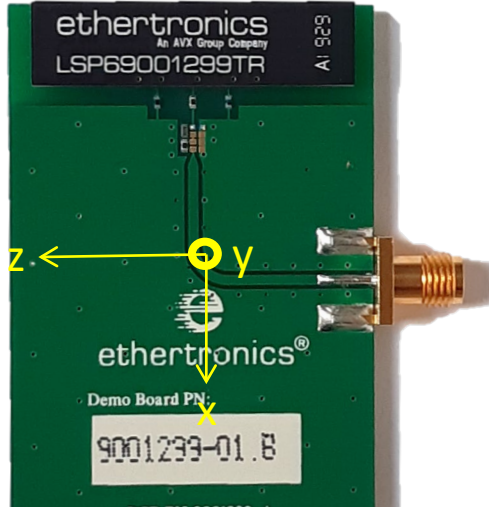

LTE Cat-M1 / NB-IoT antenna specifications  
 KYOCERA AVX produces a wide variety of standard and custom antennas to meet user needs.

### Mechanical Specifications

Typical antenna dimensions in mm

Part Number	A (mm)	B (mm)	C (mm)
LSP69001299TR	35.00 ± 0.10	9.00 ± 0.10	3.20 ± 0.10

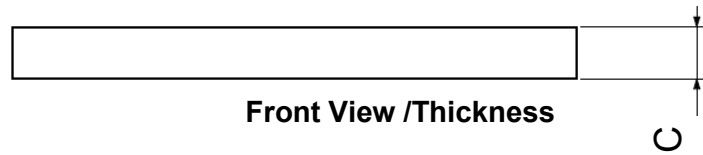
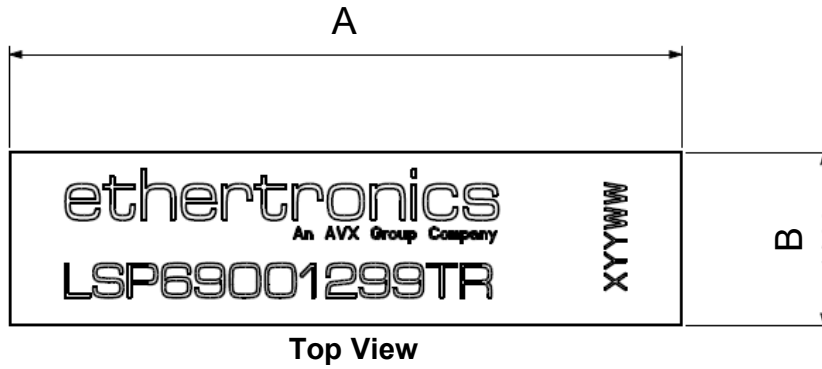

Pin#	Description
1	Dummy Pad
2	Dummy Pad
3	Ground
4	Feed
5	Ground
6	Dummy Pad
7	Dummy Pad

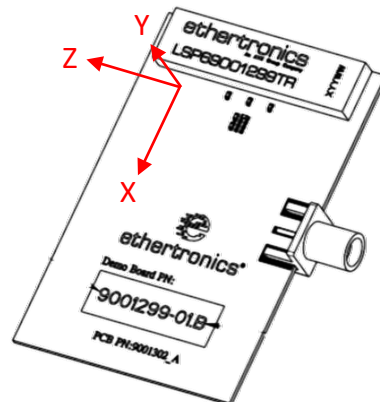
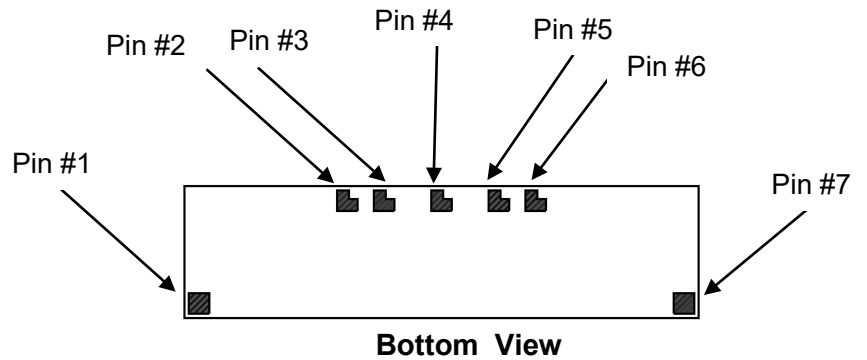

LTE Cat-M1 / NB-IoT antenna specifications  
 KYOCERA AVX produces a wide variety of standard and custom antennas to meet user needs

Antenna Layout Specifications

Typical layout dimensions in mm

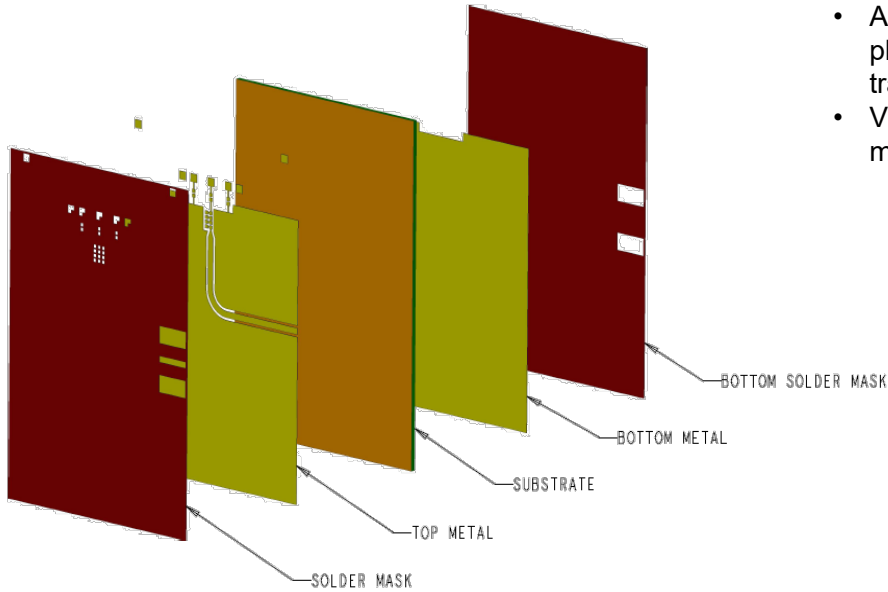

- Additional vias : Diam. 0.2 mm to be placed around antenna, (no vias on transmission lines)
- Via holes must be covered by solder mask

Pin#	Description
1	Dummy Pad
2	Dummy Pad
3	Ground
4	Feed
5	Ground
6	Dummy Pad
7	Dummy Pad

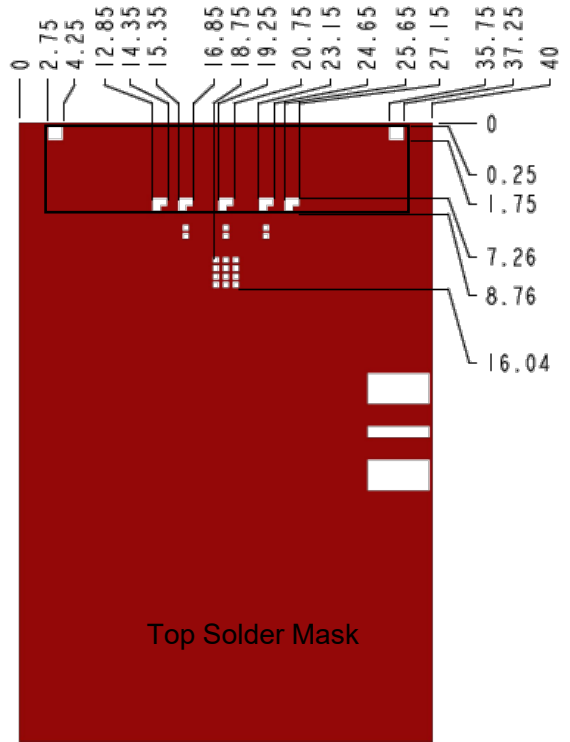
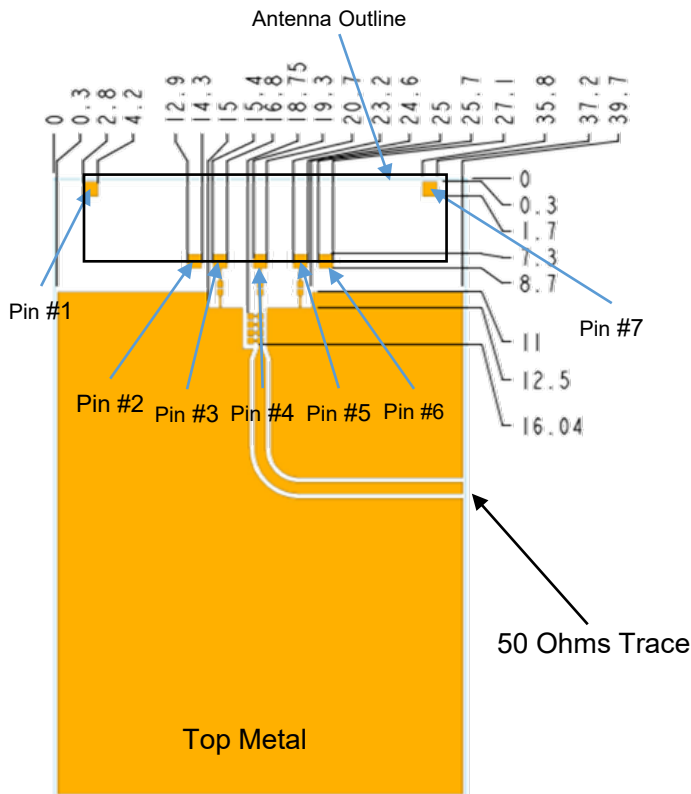

Default Pi matching Network values with instructions can be found under Antenna Matching Network.



LTE Cat-M1 / NB-IoT antenna specifications  
 KYOCERA AVX produces a wide variety of standard and custom antennas to meet user needs

### Antenna Layout Specifications

Typical layout dimensions in mm

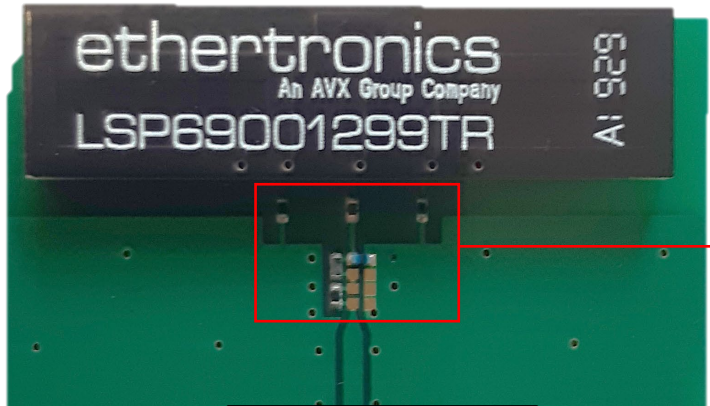

Antenna Matching component

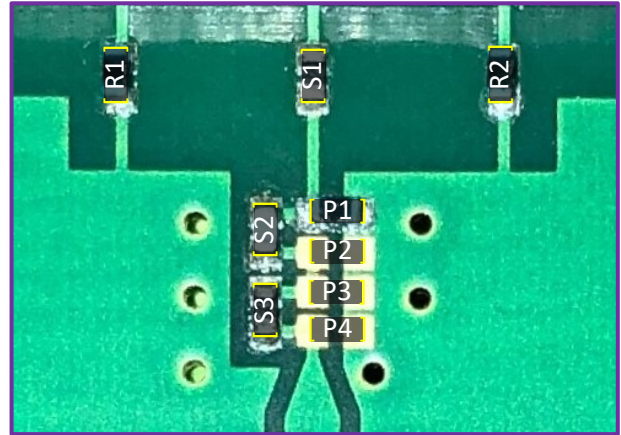

(Antenna Matching): pads are directly inline with the antenna feed trace.

Pin#	Description
1	Dummy Pad
2	Dummy Pad
3	Ground
4	Feed
5	Ground
6	Dummy Pad
7	Dummy Pad

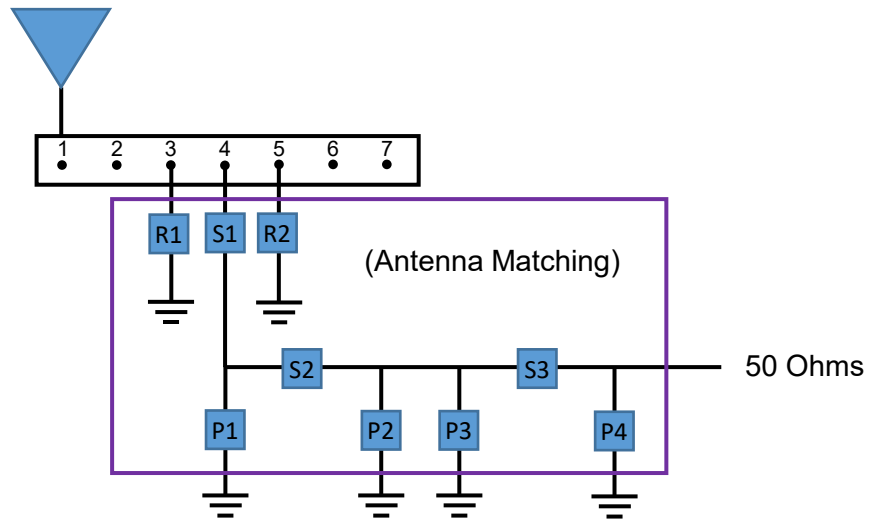

	S1/S3	S2	P1	P2/P3/P4	R1	R2
Default Matching	0 Ohm	2 pF	13 nH	DNI	20 nH	22 nH
Part Number	RC0402JR-070RL	04025J2R0PBS	LQW15AN1 3NG00D		LQW15AN20 NG00D	LQW15AN22 NG00D

LTE Cat-M1 / NB-IoT antenna specifications  
 KYOCERA AVX produces a wide variety of standard and custom antennas to meet user needs

### Recommended Reflow Soldering Profile

The recommended method for soldering the antenna to the board is forced convection reflow soldering. The following suggestions provide information on how to optimize the reflow process for the FR4 antenna:

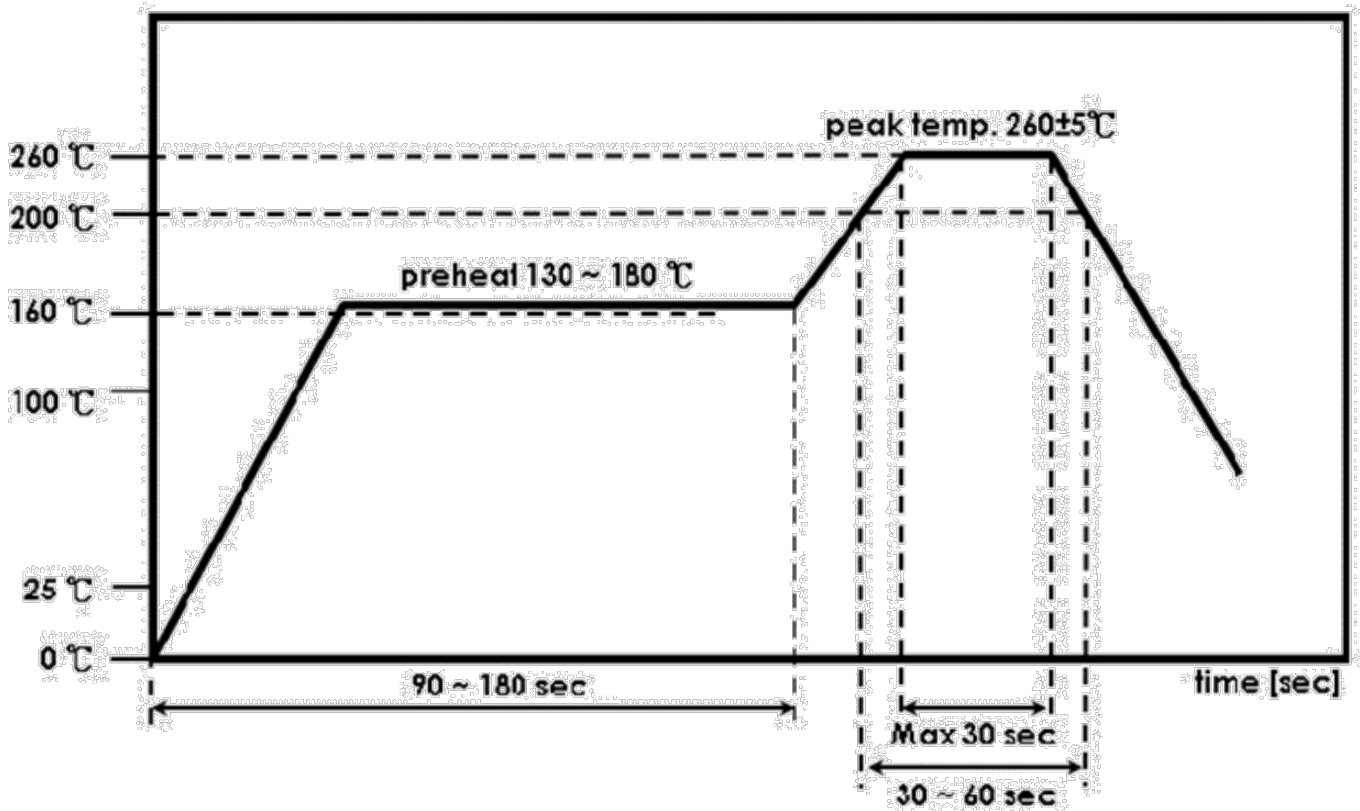

\* Adjust the reflow duration to create good solder joints without raising the antenna temperature beyond the allowed maximum of 260°C.