

DF11 Series

# 2.0mm Pitch, Double-Row Connector (UL/CSA Compliant)

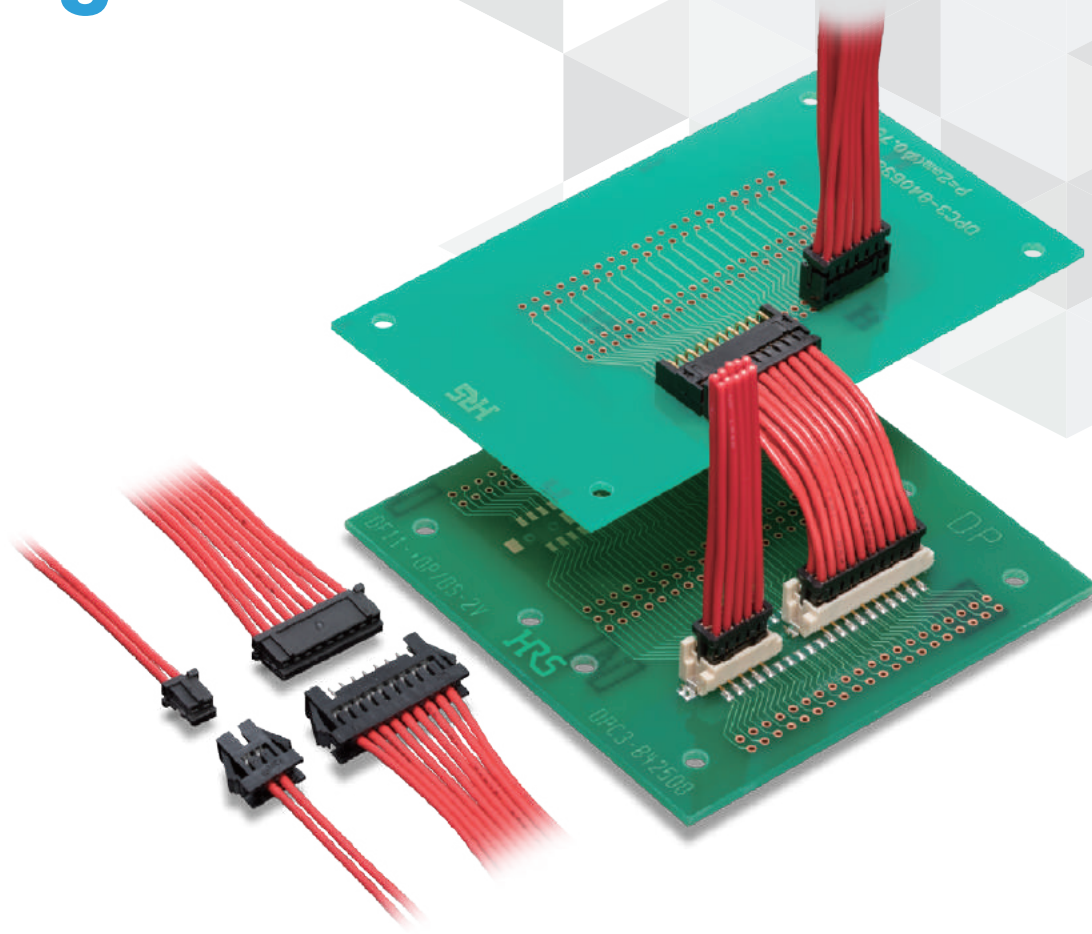
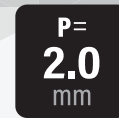

## Features

### 1. Space-saving on Board

Double row contact arrangement with 2mm pitch has been condensed within a 5mm width. Double the number of signals can be secured in the same space as a conventional 2mm single-row connector.

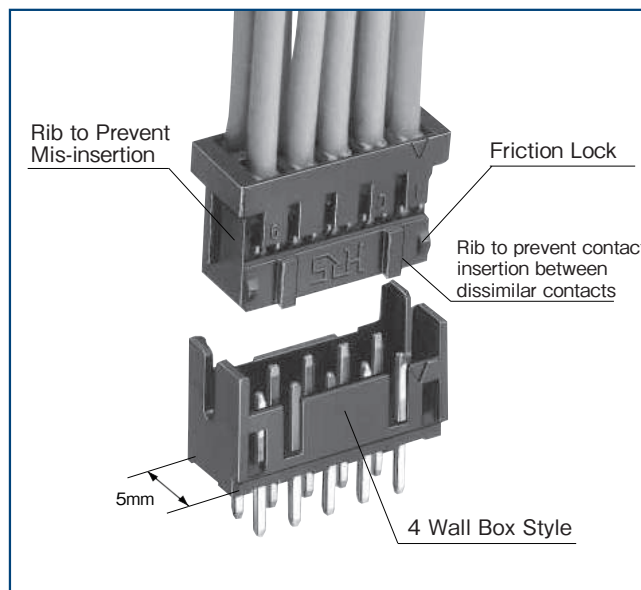

### 2. Wide Varieties

There are two types of connection methods : insulation displacement and crimping. Variations are available in cable-to-board, in-line, and board-to-board to expand PCB design freedom. Additionally, both gold and tin plating can be selected based on the application and SMT compatible products are also available.

### 3. Wide Applicable Wire Range

The double 2mm pitch rows are compact while enabling an applicable wire range of 22 to 30 AWG.

### 4. The IDC Type enables reduced assembly time

Since the DF11 insulation displacement allows double rows IDC with a single part, harnessing can be completed by machine connection alone.

## Applications

Business equipment such as copy machines, printers and so on.

## Product Specifications

| Ratings                     | Crimping              |        |        | Insulation Displacement |
|-----------------------------|-----------------------|--------|--------|-------------------------|
| Rated Current (Note 1)      | 22 to 26 AWG          | 28 AWG | 30 AWG | 26 AWG                  |
|                             | 2A                    | 1A     | 0.5A   | 1A                      |
| Rated Voltage               | 250V AC               |        |        | 100V AC                 |
| Operating Temperature Range | -30 to +85°C (Note 2) |        |        |                         |
| Operating Humidity Range    | 40 to 80% (Note 3)    |        |        |                         |
| Storage Temperature Range   | -10 to +60°C (Note 4) |        |        |                         |
| Storage Humidity Range      | 40 to 70% (Note 4)    |        |        |                         |

| UL, CSA Safety Standard Approved Specification |        |              |        |
|--|--------|--------------|--------|
| Wire Size                                      | 22 AWG | 24 to 28 AWG | 30 AWG |
| Rated Current                                  | 2A     | 1A           | 0.5A   |
| Rated Voltage                                  | 30V AC |              |        |

■ UL, CSA Safety Standard File No.

UL : E52653

CSA : LR95109

| Item                              | Specification   | Condition  |   |   |
|-----------------------------------|---|--|---|---|
| Insulation Resistance             | 1000M $\Omega$ Min.   | 500V DC  |   |   |
| Withstanding Voltage              | No flashover or insulation breakdown.   | 650V AC for 1 min.   |   |   |
| Contact Resistance                | 30m $\Omega$ Max.   | 100mA  |   |   |
| Single Insertion/Extraction Force | 0.3N (30gf) Min.<br>4.4N (450gf) Max.   | Measured by the square steel pin at $0.5 \pm 0.002$ mm   |   |   |
| Vibration                         | No electrical discontinuity of 1 $\mu$ s or more                                      | Frequency : 10 to 55Hz, single amplitude of 0.75mm,<br>2 hours in each of the 3 directions.  |   |   |
| Humidity (Steady State)           | Contact Resistance : 30m $\Omega$ Max.<br>Insulation Resistance : 500M $\Omega$ Min.  | 96 hours at temperature of $40 \pm 2^\circ\text{C}$<br>and humidity of 90 to 95%   |   |   |
| Temperature Cycle                 | Contact Resistance : 30m $\Omega$ Max.<br>Insulation Resistance : 1000M $\Omega$ Min. | (-55°C : 30 minutes $\rightarrow$ 5 to 35°C : 10 minutes<br>$\rightarrow$ 85°C : 30 minutes $\rightarrow$ 5 to 35°C : 10 minutes) 5 cycles |   |   |
| Mating Durability                 | Contact Resistance : 30m $\Omega$ Max.  | Tin Plated : 30 cycles,<br>Gold Plated : 50 cycles   |   |   |
| Resistance to Soldering Heat      | No deformation of components affecting performance.                                   | Through Hole   | Flow :<br>260°C for 10 seconds                  | Manual soldering :<br>300°C for 2 seconds |
|                                   |   | SMT  | Reflow : At the recommended temperature profile | Manual soldering :<br>300°C for 3 seconds |

Note 1 : This is the maximum current rating while all pins are powered or used as all power lines.

When isolating power lines into multiple circuits, current ratings may go above the stated current ratings.

Please consult Hirose for details before doing this. Current rating of header is 2A.

Note 2 : Includes the temperature rise due to current flow.

Note 3 : The connector should be completely dry. (no condensation)

Note 4 : The term "storage" refers to the long-term storage condition of unused products before PCB mounting.

The operating temperature and humidity ranges apply while the connector is in a non-energized state, while in transport or after PCB mounting.

## Material / Finish

| Product Type                  | Part          | Material        | Finish                    | Remarks |
|-------------------------------|---------------|-----------------|---------------------------|---------|
| Crimping Socket               | Insulator     | Polyamide       | Black                     | UL94V-0 |
| Crimping Contact for Socket   | Contact       | Phosphor Copper | Tin Plated or Gold Plated | -       |
| IDC Socket                    | Insulator     | Polyamide       | Black                     | UL94V-0 |
|                               | Contact       | Phosphor Copper | Tin Plated                | -       |
| Receptacle                    | Insulator     | Polyamide       | Black                     | UL94V-0 |
|                               | Contact       | Phosphor Copper | Tin Plated or Gold Plated | -       |
| Pin Header                    | Insulator     | Polyamide       | Black                     | UL94V-0 |
|                               | Contact       | Brass           | Tin Plated or Gold Plated | -       |
| SMT Header                    | Insulator     | Polyamide       | Beige                     | UL94V-0 |
|                               | Contact       | Brass           | Tin Plated or Gold Plated | -       |
|                               | Retention Tab | Brass           | Tin Plated                | -       |
| In-line Plug                  | Insulator     | Polyamide       | Black                     | UL94V-0 |
| In-line Plug Crimping Contact | Contact       | Phosphor Copper | Tin Plated or Gold Plated | -       |
| In-line Adaptor               | Insulator     | Polyamide       | Black                     | UL94V-0 |
|                               | Contact       | Brass           | Tin Plated                | -       |

## Product Number Structure

Refer to the chart below when determining the product specifications from the product number.  
Please select from the product numbers listed in this catalog when placing orders.

### ● Connector

## DF11 - # DS - 2 C

①      ②      ③      ④      ⑤

|                  |   |                                     |   |
|------------------|---|-------------------------------------|---|
| ① Series Name    | DF11  | ⑤ Connection Form/<br>Contact Style | C : Crimping Socket<br>R26 : IDC Socket for 26 AWG<br>DSA : Straight Through Hole<br>DS : Right Angle Through Hole<br>V : Straight SMT<br>A : Adaptor |
| ② No. of Pos.    | 4 to 32   |                                     |   |
| ③ Connector Type | DS : Double Row Socket<br>DP : Double Row Pin Header<br>DEP : Double Row In-line Plug |                                     |   |
| ④ Contact Pitch  | 2mm   |                                     |   |

### ● Contact

## DF11 - EP 2428 PCF A

①      ②      ③      ④

|                                   |  |                |                                       |
|-----------------------------------|--|----------------|---------------------------------------|
| ① Contact Type                    | EP : For In-line Plug  | ④ Plating Type | Blank : Tin Plated<br>A : Gold Plated |
| ② Applicable Wire Size            | 22 : 22 AWG<br>2428 : 24 to 28 AWG<br>30 : 30 AWG  |                |                                       |
| ③ Contact Type/<br>Packaging Type | SCF : Socket Contact, Embossed Tape<br>SC : Socket Contact, Bag<br>PCF : Plug Contact, Embossed Tape<br>PC : Plug Contact, Bag |                |                                       |

## IDC Socket

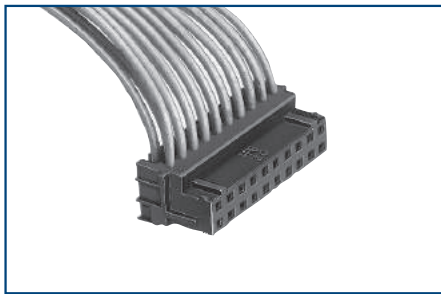

Shown Assembled with Cable

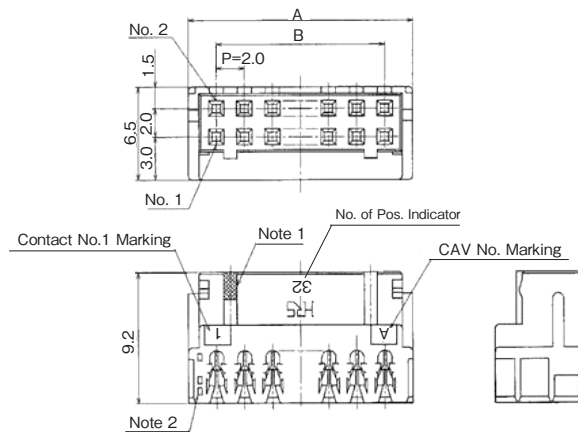

- Note 1 : Port 1-pcs indicates odd numbered rows,  
and port 2-pcs indicate even numbered rows.
- Note 2 : Use the following DIP type headers:
- Straight angle type : DF11-#DP-2DSA(08)
  - Angle type : DF11-#DP-2DS(24)

Unit : mm

| Part No.           | HRS No.          | No. of Pos. | A    | B    | Purchase Unit  |
|--------------------|------------------|-------------|------|------|----------------|
| DF11-4DS-2R26(05)  | CL0543-0652-0-05 | 4           | 6.0  | 2.0  | 100pcs per bag |
| DF11-6DS-2R26(05)  | CL0543-0653-3-05 | 6           | 8.0  | 4.0  |                |
| DF11-8DS-2R26(05)  | CL0543-0654-6-05 | 8           | 10.0 | 6.0  |                |
| DF11-10DS-2R26(05) | CL0543-0655-9-05 | 10          | 12.0 | 8.0  |                |
| DF11-12DS-2R26(05) | CL0543-0656-1-05 | 12          | 14.0 | 10.0 |                |
| DF11-14DS-2R26(05) | CL0543-0657-4-05 | 14          | 16.0 | 12.0 |                |
| DF11-16DS-2R26(05) | CL0543-0658-7-05 | 16          | 18.0 | 14.0 |                |
| DF11-18DS-2R26(05) | CL0543-0659-0-05 | 18          | 20.0 | 16.0 |                |
| DF11-20DS-2R26(05) | CL0543-0660-9-05 | 20          | 22.0 | 18.0 |                |
| DF11-22DS-2R26(05) | CL0543-0661-1-05 | 22          | 24.0 | 20.0 |                |
| DF11-24DS-2R26(05) | CL0543-0662-4-05 | 24          | 26.0 | 22.0 |                |
| DF11-26DS-2R26(05) | CL0543-0663-7-05 | 26          | 28.0 | 24.0 |                |
| DF11-28DS-2R26(05) | CL0543-0664-0-05 | 28          | 30.0 | 26.0 |                |
| DF11-30DS-2R26(05) | CL0543-0665-2-05 | 30          | 32.0 | 28.0 |                |
| DF11-32DS-2R26(05) | CL0543-0666-5-05 | 32          | 34.0 | 30.0 |                |

[Specific No.]  
(05) : Tin Plated

### ■ Applicable Cable

| Part No.      | Applicable Cable         | Jacket Diameter |
|---------------|--------------------------|-----------------|
| DF11-#DS-2R26 | UL1061 26 AWG (7/0.16mm) | φ 0.9 to 1.05mm |

### ■ DF11-#DS-2R IDC Machine

| Type                | Part No.                       | Connection Type                                | Remarks                       |
|---------------------|--------------------------------|--|-------------------------------|
| Desktop IDC Machine | SA700/DF11<br>CL0903-0013-5-00 | Used for DF11 only,<br>No restricted condition | Desktop machine for small lot |

## Crimping Socket



Shown Assembled with Cable

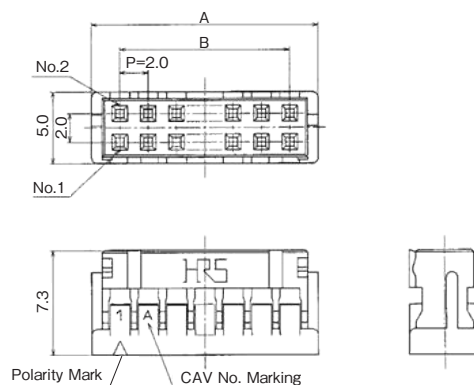

Unit : mm

| Part No.     | HRS No.          | No. of Pos. | A    | B    | Purchase Unit     |
|--------------|------------------|-------------|------|------|-------------------|
| DF11-4DS-2C  | CL0543-0568-6-00 | 4           | 6.0  | 2.0  | 100pcs<br>per bag |
| DF11-6DS-2C  | CL0543-0502-8-00 | 6           | 8.0  | 4.0  |                   |
| DF11-8DS-2C  | CL0543-0503-0-00 | 8           | 10.0 | 6.0  |                   |
| DF11-10DS-2C | CL0543-0504-3-00 | 10          | 12.0 | 8.0  |                   |
| DF11-12DS-2C | CL0543-0505-6-00 | 12          | 14.0 | 10.0 |                   |
| DF11-14DS-2C | CL0543-0506-9-00 | 14          | 16.0 | 12.0 |                   |
| DF11-16DS-2C | CL0543-0507-1-00 | 16          | 18.0 | 14.0 |                   |
| DF11-18DS-2C | CL0543-0508-4-00 | 18          | 20.0 | 16.0 |                   |
| DF11-20DS-2C | CL0543-0509-7-00 | 20          | 22.0 | 18.0 |                   |
| DF11-22DS-2C | CL0543-0510-6-00 | 22          | 24.0 | 20.0 |                   |
| DF11-24DS-2C | CL0543-0511-9-00 | 24          | 26.0 | 22.0 |                   |
| DF11-26DS-2C | CL0543-0512-1-00 | 26          | 28.0 | 24.0 |                   |
| DF11-28DS-2C | CL0543-0513-4-00 | 28          | 30.0 | 26.0 |                   |
| DF11-30DS-2C | CL0543-0514-7-00 | 30          | 32.0 | 28.0 |                   |
| DF11-32DS-2C | CL0543-0515-0-00 | 32          | 34.0 | 30.0 |                   |

## Receptacle (Through Hole)

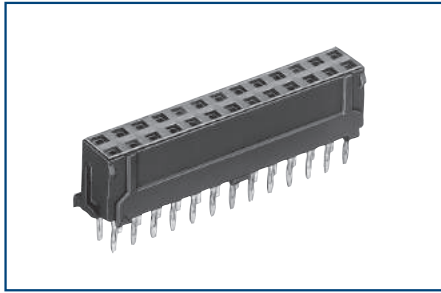

- Board Through-hole Diameter :  $\phi 0.8^{+0.1}_0$
- Diameter of Board Hole for Kink Pin Securing :  $\phi 0.8^{+0.05}_0$

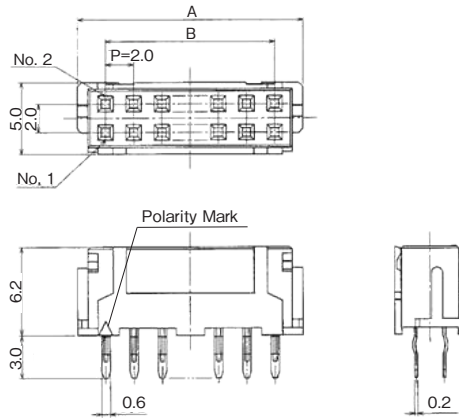

Unit : mm

| Part No.           | HRS No.          | No. of Pos. | A    | B    | Purchase Unit     |
|--------------------|------------------|-------------|------|------|-------------------|
| DF11-6DS-2DSA(##)  | CL0543-0553-9-## | 6           | 8.0  | 4.0  | 100pcs<br>per bag |
| DF11-8DS-2DSA(##)  | CL0543-0554-1-## | 8           | 10.0 | 6.0  |                   |
| DF11-10DS-2DSA(##) | CL0543-0555-4-## | 10          | 12.0 | 8.0  |                   |
| DF11-12DS-2DSA(##) | CL0543-0556-7-## | 12          | 14.0 | 10.0 |                   |
| DF11-14DS-2DSA(##) | CL0543-0557-0-## | 14          | 16.0 | 12.0 |                   |
| DF11-16DS-2DSA(##) | CL0543-0558-2-## | 16          | 18.0 | 14.0 |                   |
| DF11-18DS-2DSA(##) | CL0543-0559-5-## | 18          | 20.0 | 16.0 |                   |
| DF11-20DS-2DSA(##) | CL0543-0560-4-## | 20          | 22.0 | 18.0 |                   |
| DF11-22DS-2DSA(##) | CL0543-0561-7-## | 22          | 24.0 | 20.0 |                   |
| DF11-24DS-2DSA(##) | CL0543-0562-0-## | 24          | 26.0 | 22.0 |                   |
| DF11-26DS-2DSA(##) | CL0543-0563-2-## | 26          | 28.0 | 24.0 |                   |
| DF11-28DS-2DSA(##) | CL0543-0564-5-## | 28          | 30.0 | 26.0 |                   |
| DF11-30DS-2DSA(##) | CL0543-0565-8-## | 30          | 32.0 | 28.0 |                   |
| DF11-32DS-2DSA(##) | CL0543-0566-0-## | 32          | 34.0 | 30.0 |                   |

[Specific No.] -##,(##)

(05) : Tin Plated

(06) : Gold Plated



## Receptacle (SMT)

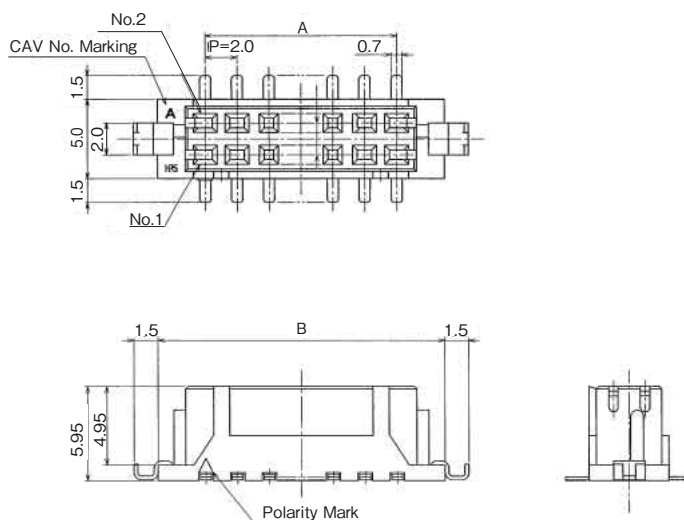
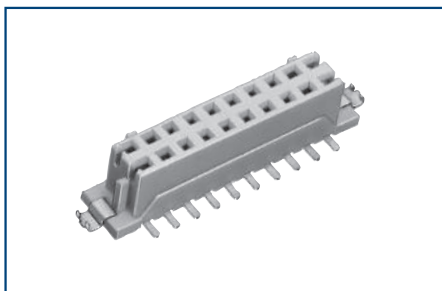

### PCB Mounting Pattern

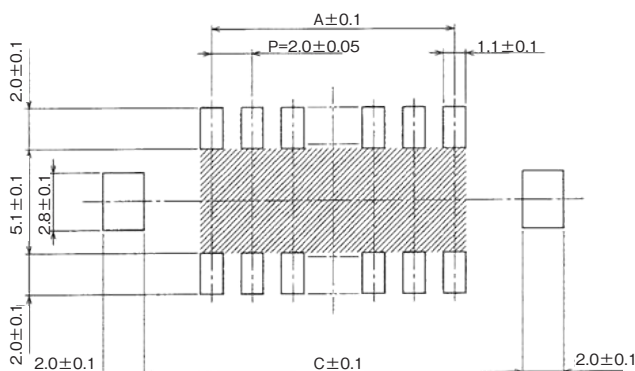

Note : If the shaded area has a pattern and is not treated with resist it may touch the connector contact.

Unit : mm

| Part No.           | HRS No.          | No. of Pos. | A    | B    | C    | Purchase Unit      |
|--------------------|------------------|-------------|------|------|------|--------------------|
| DF11CZ-4DS-2V(##)  | CL0543-2063-0-## | 4           | 2.0  | 8.5  | 8.7  | 500pcs<br>per reel |
| DF11CZ-6DS-2V(##)  | CL0543-2064-3-## | 6           | 4.0  | 10.5 | 10.7 |                    |
| DF11CZ-8DS-2V(##)  | CL0543-2065-6-## | 8           | 6.0  | 12.5 | 12.7 |                    |
| DF11CZ-10DS-2V(##) | CL0543-2066-9-## | 10          | 8.0  | 14.5 | 14.7 |                    |
| DF11CZ-12DS-2V(##) | CL0543-2067-1-## | 12          | 10.0 | 16.5 | 16.7 |                    |
| DF11CZ-14DS-2V(##) | CL0543-2068-4-## | 14          | 12.0 | 18.5 | 18.7 |                    |
| DF11CZ-16DS-2V(##) | CL0543-2069-7-## | 16          | 14.0 | 20.5 | 20.7 |                    |
| DF11CZ-18DS-2V(##) | CL0543-2070-6-## | 18          | 16.0 | 22.5 | 22.7 |                    |
| DF11CZ-20DS-2V(##) | CL0543-2071-9-## | 20          | 18.0 | 24.5 | 24.7 |                    |
| DF11CZ-22DS-2V(##) | CL0543-2072-1-## | 22          | 20.0 | 26.5 | 26.7 |                    |
| DF11CZ-24DS-2V(##) | CL0543-2073-4-## | 24          | 22.0 | 28.5 | 28.7 |                    |
| DF11CZ-26DS-2V(##) | CL0543-2074-7-## | 26          | 24.0 | 30.5 | 30.7 |                    |
| DF11CZ-28DS-2V(##) | CL0543-2075-0-## | 28          | 26.0 | 32.5 | 32.7 |                    |
| DF11CZ-30DS-2V(##) | CL0543-2076-2-## | 30          | 28.0 | 34.5 | 34.7 |                    |
| DF11CZ-40DS-2V(##) | CL0543-0584-2-## | 40          | 38.0 | 44.5 | 44.7 |                    |

[Specific No.] -##, (##)

(22) : Tin Plated Embossed Tape Packaging (with Vacuum Pick-up Cap)

(52) : Gold Plated Embossed Tape Packaging (with Vacuum Pick-up Cap)

Note 1 : The 40pos. connector can only be combined with SMT products.

Note 2 : Embossed packaging products have the reel wrapped in polyethylene and include a desiccant.

## Straight Pin Header

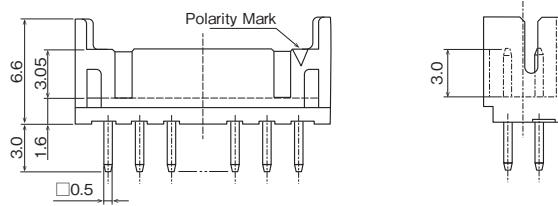
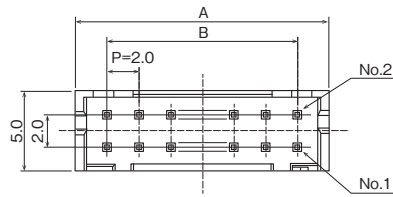
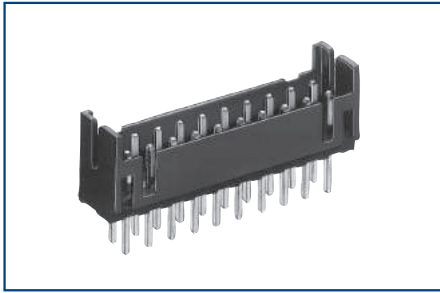

● Board Through-hole Diameter :  $\phi 0.8^{+0.1}_0$

Unit : mm

| Part No.           | HRS No.          | No. of Pos. | A    | B    | Purchase Unit (##) : (01) | Purchase Unit (##) : (08) | Purchase Unit (##) : (24) |
|--------------------|------------------|-------------|------|------|---------------------------|---------------------------|---------------------------|
| DF11-4DP-2DSA(##)  | CL0543-0517-5-## | 4           | 6.0  | 2.0  | 100pcs per bag            | 100pcs per bag            | 81pcs per tube            |
| DF11-6DP-2DSA(##)  | CL0543-0518-8-## | 6           | 8.0  | 4.0  |                           |                           | 61pcs per tube            |
| DF11-8DP-2DSA(##)  | CL0543-0519-0-## | 8           | 10.0 | 6.0  |                           |                           | 49pcs per tube            |
| DF11-10DP-2DSA(##) | CL0543-0520-0-## | 10          | 12.0 | 8.0  |                           |                           | 40pcs per tube            |
| DF11-12DP-2DSA(##) | CL0543-0521-2-## | 12          | 14.0 | 10.0 |                           |                           | 34pcs per tube            |
| DF11-14DP-2DSA(##) | CL0543-0522-5-## | 14          | 16.0 | 12.0 |                           |                           | 30pc per tube             |
| DF11-16DP-2DSA(##) | CL0543-0523-8-## | 16          | 18.0 | 14.0 |                           |                           | 27pcs per tube            |
| DF11-18DP-2DSA(##) | CL0543-0524-0-## | 18          | 20.0 | 16.0 |                           |                           | 24pcs per tube            |
| DF11-20DP-2DSA(##) | CL0543-0525-3-## | 20          | 22.0 | 18.0 |                           |                           | 22pcs per tube            |
| DF11-22DP-2DSA(##) | CL0543-0526-6-## | 22          | 24.0 | 20.0 |                           |                           | 20pcs per tube            |
| DF11-24DP-2DSA(##) | CL0543-0527-9-## | 24          | 26.0 | 22.0 |                           |                           | 18pcs per tube            |
| DF11-26DP-2DSA(##) | CL0543-0528-1-## | 26          | 28.0 | 24.0 |                           |                           | 17pcs per tube            |
| DF11-28DP-2DSA(##) | CL0543-0529-4-## | 28          | 30.0 | 26.0 |                           |                           | 16pcs per tube            |
| DF11-30DP-2DSA(##) | CL0543-0530-3-## | 30          | 32.0 | 28.0 |                           |                           | 15pcs per tube            |
| DF11-32DP-2DSA(##) | CL0543-0531-6-## | 32          | 34.0 | 30.0 |                           |                           | 14pcs per tube            |

[Specific No.] -##.(##)

(01) : Gold Plated

(08) : Tin Plated

(24) : Tin Plated

## Right Angle Pin Header

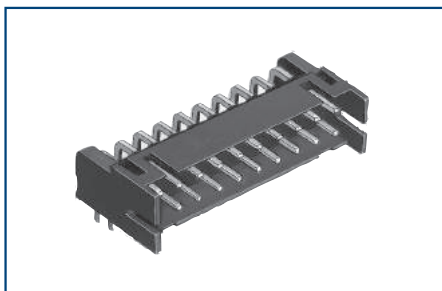

● Board Through-hole Diameter :  $\phi 0.8^{+0.1}_0$

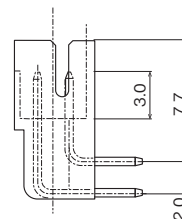
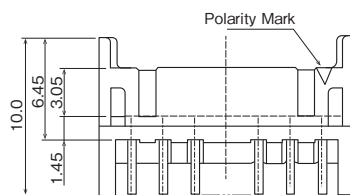
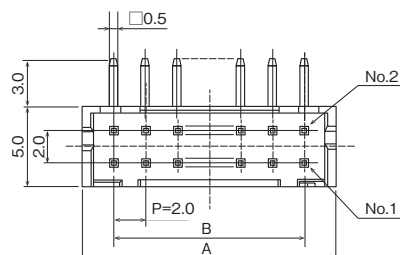

Unit : mm

| Part No.          | HRS No.          | No. of Pos. | A    | B    | Purchase Unit  |
|-------------------|------------------|-------------|------|------|----------------|
| DF11-4DP-2DS(##)  | CL0543-0533-1-## | 4           | 6.0  | 2.0  | 81pcs per tube |
| DF11-6DP-2DS(##)  | CL0543-0534-4-## | 6           | 8.0  | 4.0  | 61pcs per tube |
| DF11-8DP-2DS(##)  | CL0543-0535-7-## | 8           | 10.0 | 6.0  | 48pcs per tube |
| DF11-10DP-2DS(##) | CL0543-0536-0-## | 10          | 12.0 | 8.0  | 40pcs per tube |
| DF11-12DP-2DS(##) | CL0543-0537-2-## | 12          | 14.0 | 10.0 | 34pcs per tube |
| DF11-14DP-2DS(##) | CL0543-0538-5-## | 14          | 16.0 | 12.0 | 30pcs per tube |
| DF11-16DP-2DS(##) | CL0543-0539-8-## | 16          | 18.0 | 14.0 | 27pcs per tube |
| DF11-18DP-2DS(##) | CL0543-0540-7-## | 18          | 20.0 | 16.0 | 24pcs per tube |
| DF11-20DP-2DS(##) | CL0543-0541-0-## | 20          | 22.0 | 18.0 | 22pcs per tube |
| DF11-22DP-2DS(##) | CL0543-0542-2-## | 22          | 24.0 | 20.0 | 20pcs per tube |
| DF11-24DP-2DS(##) | CL0543-0543-5-## | 24          | 26.0 | 22.0 | 18pcs per tube |
| DF11-26DP-2DS(##) | CL0543-0544-8-## | 26          | 28.0 | 24.0 | 17pcs per tube |
| DF11-28DP-2DS(##) | CL0543-0545-0-## | 28          | 30.0 | 26.0 | 16pcs per tube |
| DF11-30DP-2DS(##) | CL0543-0546-3-## | 30          | 32.0 | 28.0 | 15pcs per tube |
| DF11-32DP-2DS(##) | CL0543-0547-6-## | 32          | 34.0 | 30.0 | 14pcs per tube |

[Specific No.] -##.(##)

(24) : Tin Plated

(52) : Gold Plated

## Straight Pin Header (SMT)

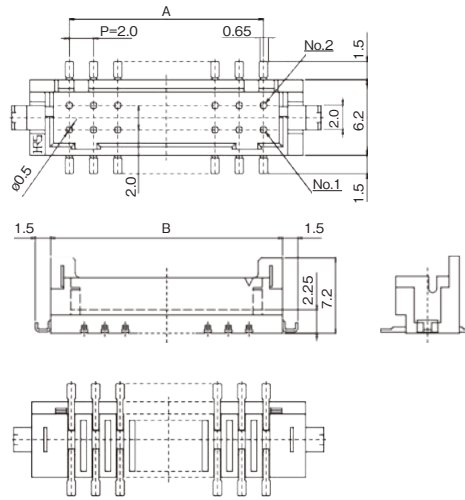
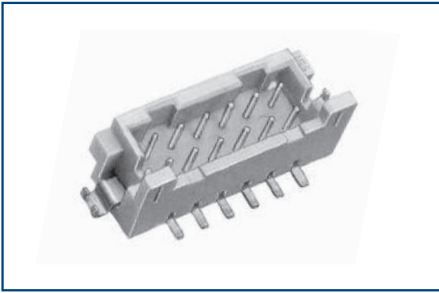

### PCB Mounting Pattern

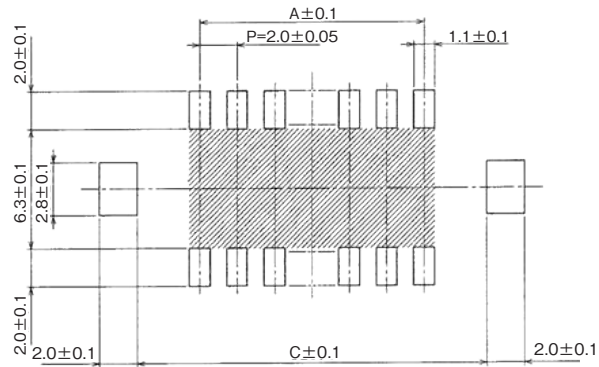

Note : If the shaded area has a pattern and is not treated with resist it may touch the connector contact.

Unit : mm

| Tin Plated         |                  | Gold Plated       |                  | No. of Pos. | A    | B    | C    | Purchase Unit      |
|--------------------|------------------|-------------------|------------------|-------------|------|------|------|--------------------|
| Part No.           | HRS No.          | Part No.          | HRS No.          |             |      |      |      |                    |
| DF11CZ-4DP-2V(27)  | CL0543-2047-4-27 | DF11C-4DP-2V(57)  | CL0543-0682-1-57 | 4           | 2.0  | 8.5  | 8.7  | 500pcs<br>per reel |
| DF11CZ-6DP-2V(27)  | CL0543-2048-7-27 | DF11C-6DP-2V(57)  | CL0543-0683-4-57 | 6           | 4.0  | 10.5 | 10.7 |                    |
| DF11CZ-8DP-2V(27)  | CL0543-2049-0-27 | DF11C-8DP-2V(57)  | CL0543-0684-7-57 | 8           | 6.0  | 12.5 | 12.7 |                    |
| DF11CZ-10DP-2V(27) | CL0543-2050-9-27 | DF11C-10DP-2V(57) | CL0543-0685-0-57 | 10          | 8.0  | 14.5 | 14.7 |                    |
| DF11CZ-12DP-2V(27) | CL0543-2051-1-27 | DF11C-12DP-2V(57) | CL0543-0686-2-57 | 12          | 10.0 | 16.5 | 16.7 |                    |
| DF11CZ-14DP-2V(27) | CL0543-2052-4-27 | DF11C-14DP-2V(57) | CL0543-0687-5-57 | 14          | 12.0 | 18.5 | 18.7 |                    |
| DF11CZ-16DP-2V(27) | CL0543-2053-7-27 | DF11C-16DP-2V(57) | CL0543-0688-8-57 | 16          | 14.0 | 20.5 | 20.7 |                    |
| DF11CZ-18DP-2V(27) | CL0543-2054-0-27 | DF11C-18DP-2V(57) | CL0543-0689-0-57 | 18          | 16.0 | 22.5 | 22.7 |                    |
| DF11CZ-20DP-2V(27) | CL0543-2055-2-27 | DF11C-20DP-2V(57) | CL0543-0690-0-57 | 20          | 18.0 | 24.5 | 24.7 |                    |
| DF11CZ-22DP-2V(27) | CL0543-2056-5-27 | DF11C-22DP-2V(57) | CL0543-0691-2-57 | 22          | 20.0 | 26.5 | 26.7 |                    |
| DF11CZ-24DP-2V(27) | CL0543-2057-8-27 | DF11C-24DP-2V(57) | CL0543-0692-5-57 | 24          | 22.0 | 28.5 | 28.7 |                    |
| DF11CZ-26DP-2V(27) | CL0543-2058-0-27 | DF11C-26DP-2V(57) | CL0543-0693-8-57 | 26          | 24.0 | 30.5 | 30.7 |                    |
| DF11CZ-28DP-2V(27) | CL0543-2059-3-27 | DF11C-28DP-2V(57) | CL0543-0694-0-57 | 28          | 26.0 | 32.5 | 32.7 |                    |
| DF11CZ-30DP-2V(27) | CL0543-2060-2-27 | DF11C-30DP-2V(57) | CL0543-0695-3-57 | 30          | 28.0 | 34.5 | 34.7 |                    |
| DF11CZ-32DP-2V(27) | CL0543-2061-5-27 | DF11C-32DP-2V(57) | CL0543-0696-6-57 | 32          | 30.0 | 36.5 | 36.7 |                    |
| DF11CZ-40DP-2V(27) | CL0543-2062-8-27 | DF11C-40DP-2V(57) | CL0543-0697-9-57 | 40          | 38.0 | 44.5 | 44.7 |                    |

[Specific No.] -##,(##)

(27) : Tin Plated Embossed Tape Packaging (with Vacuum Pick-up Cap)

(57) : Gold Plated Embossed Tape Packaging (with Vacuum Pick-up Cap)

Note 1 : The 40pos. connector can only be combined with SMT products.

Note 2 : Embossed packaging products have the reel wrapped in polyethylene and include a desiccant.

Note 3 : There may be blisters on the mold surfaces excluding the mating face during mounting. However this does not affect the product performance.

## In-line Plug

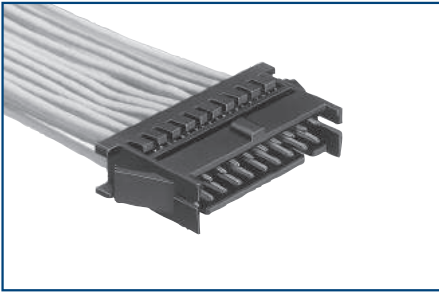

Shown Assembled with Cable

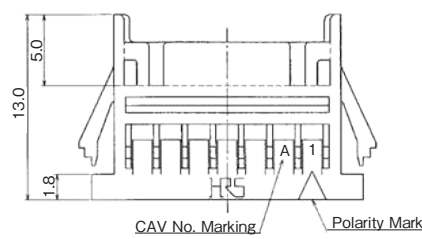
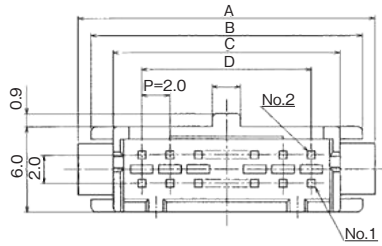

### In-line Plug Panel Cutouts

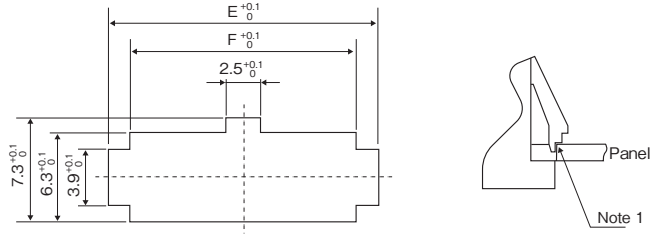

Note 1 : Please use the non-radius side for the panel hooking area.

Note 2 : Applicable panel thickness is 1.6 to 1.0mm

(Slight misalignment may occur for the panel thicknesses excluding 1.6 and 1.2mm.)

| Part No.      | HRS No.          | No. of Pos. | A    | B    | C    | D    | E    | F    | Purchase Unit     |
|---------------|------------------|-------------|------|------|------|------|------|------|-------------------|
| DF11-4DEP-2C  | CL0543-0619-5-00 | 4           | 11.0 | 9.2  | 6.0  | 2.0  | 9.4  | 6.3  | 100pcs<br>per bag |
| DF11-6DEP-2C  | CL0543-0620-4-00 | 6           | 13.0 | 11.2 | 8.0  | 4.0  | 11.4 | 8.3  |                   |
| DF11-8DEP-2C  | CL0543-0621-7-00 | 8           | 15.0 | 13.2 | 10.0 | 6.0  | 13.4 | 10.3 |                   |
| DF11-10DEP-2C | CL0543-0622-0-00 | 10          | 17.0 | 15.2 | 12.0 | 8.0  | 15.4 | 12.3 |                   |
| DF11-12DEP-2C | CL0543-0623-2-00 | 12          | 19.0 | 17.2 | 14.0 | 10.0 | 17.4 | 14.3 |                   |
| DF11-14DEP-2C | CL0543-0624-5-00 | 14          | 21.0 | 19.2 | 16.0 | 12.0 | 19.4 | 16.3 |                   |
| DF11-16DEP-2C | CL0543-0625-8-00 | 16          | 23.0 | 21.2 | 18.0 | 14.0 | 21.4 | 18.3 |                   |
| DF11-18DEP-2C | CL0543-0626-0-00 | 18          | 25.0 | 23.2 | 20.0 | 16.0 | 23.4 | 20.3 |                   |
| DF11-20DEP-2C | CL0543-0627-3-00 | 20          | 27.0 | 25.2 | 22.0 | 18.0 | 25.4 | 22.3 |                   |
| DF11-22DEP-2C | CL0543-0628-6-00 | 22          | 29.0 | 27.2 | 24.0 | 20.0 | 27.4 | 24.3 |                   |
| DF11-24DEP-2C | CL0543-0629-9-00 | 24          | 31.0 | 29.2 | 26.0 | 22.0 | 29.4 | 26.3 |                   |
| DF11-26DEP-2C | CL0543-0630-8-00 | 26          | 33.0 | 31.2 | 28.0 | 24.0 | 31.4 | 28.3 |                   |
| DF11-28DEP-2C | CL0543-0631-0-00 | 28          | 35.0 | 33.2 | 30.0 | 26.0 | 33.4 | 30.3 |                   |
| DF11-30DEP-2C | CL0543-0632-3-00 | 30          | 37.0 | 35.2 | 32.0 | 28.0 | 35.4 | 32.3 |                   |
| DF11-32DEP-2C | CL0543-0633-6-00 | 32          | 39.0 | 37.2 | 34.0 | 30.0 | 37.4 | 34.3 |                   |

Unit : mm

## In-line Adaptor

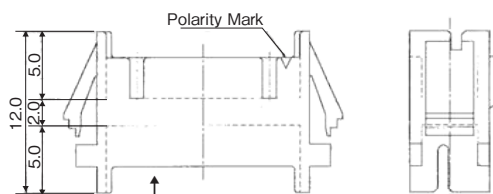
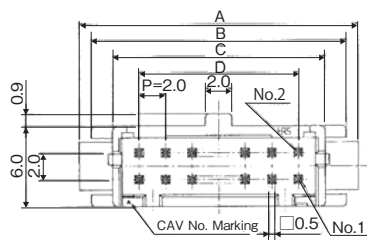
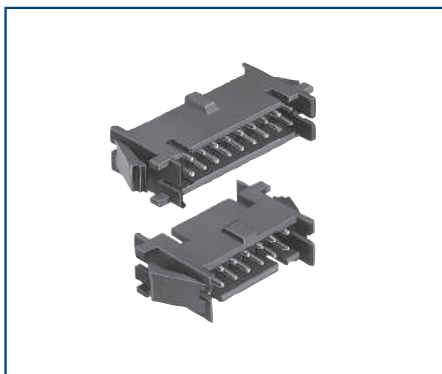

Note : The insertion and extraction force is higher on this side.

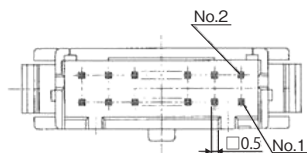

### In-line Adaptor Panel Cutouts

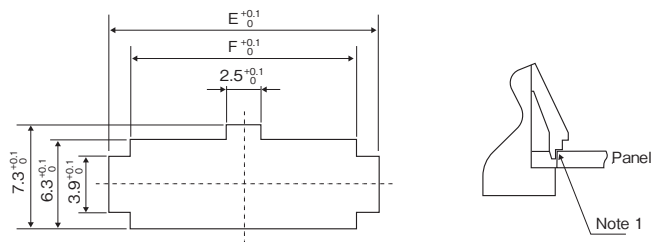

Note 1 : Please use the non-radius surface in the panel hooking area.

Note 2 : Applicable panel thickness is 1.6 to 1.0mm

(Slight misalignment may occur for the panel thicknesses excluding 1.6 and 1.2mm.)

| Part No.      | HRS No.          | No. of Pos. | A    | B    | C    | D    | E    | F    | Purchase Unit     |
|---------------|------------------|-------------|------|------|------|------|------|------|-------------------|
| DF11-4DEP-2A  | CL0543-0698-1-00 | 4           | 11.0 | 9.2  | 6.0  | 2.0  | 9.4  | 6.3  | 100pcs<br>per bag |
| DF11-6DEP-2A  | CL0543-0699-4-00 | 6           | 13.0 | 11.2 | 8.0  | 4.0  | 11.4 | 8.3  |                   |
| DF11-8DEP-2A  | CL0543-0700-1-00 | 8           | 15.0 | 13.2 | 10.0 | 6.0  | 13.4 | 10.3 |                   |
| DF11-10DEP-2A | CL0543-0701-4-00 | 10          | 17.0 | 15.2 | 12.0 | 8.0  | 15.4 | 12.3 |                   |
| DF11-12DEP-2A | CL0543-0702-7-00 | 12          | 19.0 | 17.2 | 14.0 | 10.0 | 17.4 | 14.3 |                   |
| DF11-14DEP-2A | CL0543-0703-0-00 | 14          | 21.0 | 19.2 | 16.0 | 12.0 | 19.4 | 16.3 |                   |
| DF11-16DEP-2A | CL0543-0704-2-00 | 16          | 23.0 | 21.2 | 18.0 | 14.0 | 21.4 | 18.3 |                   |
| DF11-18DEP-2A | CL0543-0705-5-00 | 18          | 25.0 | 23.2 | 20.0 | 16.0 | 23.4 | 20.3 |                   |
| DF11-20DEP-2A | CL0543-0706-8-00 | 20          | 27.0 | 25.2 | 22.0 | 18.0 | 25.4 | 22.3 |                   |
| DF11-22DEP-2A | CL0543-0707-0-00 | 22          | 29.0 | 27.2 | 24.0 | 20.0 | 27.4 | 24.3 |                   |
| DF11-24DEP-2A | CL0543-0708-3-00 | 24          | 31.0 | 29.2 | 26.0 | 22.0 | 29.4 | 26.3 |                   |
| DF11-26DEP-2A | CL0543-0709-6-00 | 26          | 33.0 | 31.2 | 28.0 | 24.0 | 31.4 | 28.3 |                   |
| DF11-28DEP-2A | CL0543-0710-5-00 | 28          | 35.0 | 33.2 | 30.0 | 26.0 | 33.4 | 30.3 |                   |
| DF11-30DEP-2A | CL0543-0711-8-00 | 30          | 37.0 | 35.2 | 32.0 | 28.0 | 35.4 | 32.3 |                   |
| DF11-32DEP-2A | CL0543-0712-0-00 | 32          | 39.0 | 37.2 | 34.0 | 30.0 | 37.4 | 34.3 |                   |

Unit : mm

## Crimping Contact for Socket

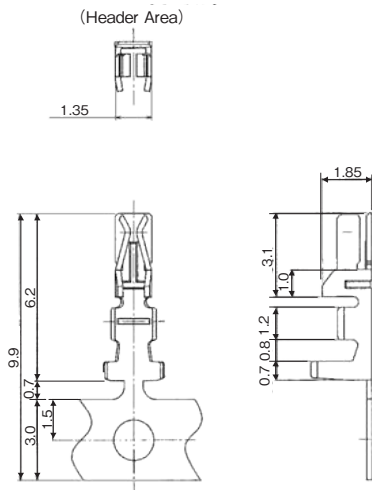

### ◆ Reel Contact (Applicable Tool : Applicator)

| Part No.               | HRS No.          | Finish      | Purchase Unit      | Applicable Wire (Tin Plated Annealed Copper Wire) (Note 2) |                            |  |  |                   |
|------------------------|------------------|-------------|--------------------|--|----------------------------|--|--|-------------------|
|                        |                  |             |                    | UL   | Wire Size                  | Standed Wire Conductor                   | Calculated Cross-section   | Jacket Outer Dia. |
| DF11-22SCF             | CL0543-0601-0-00 | Tin Plated  | 10,000pcs per reel | 1061   | 22 AWG                     | 17 / 0.16mm                              | 0.342mm <sup>2</sup>   | 1.2 to 1.45mm     |
| DF11-22SCFA(04)        | CL0543-0603-5-04 | Gold Plated |                    | 1061   | 22 AWG                     | 17 / 0.16mm                              | 0.342mm <sup>2</sup>   | 1.2 to 1.45mm     |
| DF11-2428SCF           | CL0543-0500-2-00 | Tin Plated  |                    | 1061, 1007   | 24 AWG<br>26 AWG<br>28 AWG | 11 / 0.16mm<br>7 / 0.16mm<br>7 / 0.127mm | 0.221mm <sup>2</sup><br>0.141mm <sup>2</sup><br>0.089mm <sup>2</sup> | 0.9 to 1.45mm     |
| DF11A-2428SCF (Note 1) | CL0543-0634-9-00 | Tin Plated  |                    | 1061, 1007   | 24 AWG<br>26 AWG<br>28 AWG | 11 / 0.16mm<br>7 / 0.16mm<br>7 / 0.127mm | 0.221mm <sup>2</sup><br>0.141mm <sup>2</sup><br>0.089mm <sup>2</sup> | 0.9 to 1.45mm     |
| DF11-2428SCFA(04)      | CL0543-0550-0-04 | Gold Plated |                    | 1061, 1007   | 24 AWG<br>26 AWG<br>28 AWG | 11 / 0.16mm<br>7 / 0.16mm<br>7 / 0.127mm | 0.221mm <sup>2</sup><br>0.141mm <sup>2</sup><br>0.089mm <sup>2</sup> | 0.9 to 1.45mm     |
| DF11-30SCF             | CL0543-0605-0-00 | Tin Plated  |                    | 1061, 1007   | 30 AWG                     | 7 / 0.1mm                                | 0.055mm <sup>2</sup>   | 0.75 to 1.2mm     |
| DF11-30SCFA(04)        | CL0543-0607-6-04 | Gold Plated |                    | 1061, 1007   | 30 AWG                     | 7 / 0.1mm                                | 0.055mm <sup>2</sup>   | 0.75 to 1.2mm     |

● Strip Length : 1.7 to 2.3mm

Note 1 : DF11A-2428SCF is the low insertion/extraction tin plated type.

Note 2 : Contact your Hirose representative if considering use of non-specified cables.

Note 3 : The strip length is a reference value. Adjust so that each dimension after crimping meets the specified value.

Refer to the Crimp Quality Standard (ETAD-H0773-00) for details.



## ◆ Loose Contact (Applicable Tool : Hand Crimping Tool)

| Part No.              | HRS No.          | Finish      | Purchase Unit  | Applicable Wire (Tin Plated Annealed Copper Wire) (Note 2) |             |                        |                          |                      |
|-----------------------|------------------|-------------|----------------|--|-------------|------------------------|--------------------------|----------------------|
|                       |                  |             |                | UL   | Wire Size   | Standed Wire Conductor | Calculated Cross-section | Jacket Outer Dia.    |
| DF11-22SC             | CL0543-0602-2-00 | Tin Plated  | 100pcs per bag | 1061   | 22 AWG      | 17 / 0.16mm            | 0.342mm <sup>2</sup>     | 1.3mm                |
| DF11-22SCA            | CL0543-0604-8-00 | Gold Plated |                | 1061   | 22 AWG      | 17 / 0.16mm            | 0.342mm <sup>2</sup>     | 1.3mm                |
| DF11-2428SC           | CL0543-0501-5-00 | Tin Plated  |                | 1061   | 24 AWG      | 11 / 0.16mm            | 0.221mm <sup>2</sup>     | 1.1mm                |
|                       |                  |             |                |  | 26 AWG      | 7 / 0.16mm             | 0.141mm <sup>2</sup>     | 1.0mm                |
| DF11-2428SC           | CL0543-0501-5-00 | Tin Plated  |                | 1061   | 28 AWG      | 7 / 0.127mm            | 0.089mm <sup>2</sup>     | 0.9mm                |
|                       |                  |             |                |  | 1007        | 24 AWG                 | 11 / 0.16mm              | 0.221mm <sup>2</sup> |
| DF11-2428SC           | CL0543-0501-5-00 | Tin Plated  |                | 1007   |             | 26 AWG                 | 7 / 0.16mm               | 0.141mm <sup>2</sup> |
|                       |                  |             |                |  | 28 AWG      | 7 / 0.127mm            | 0.089mm <sup>2</sup>     | 1.2mm                |
| DF11A-2428SC (Note 1) | CL0543-0635-1-00 | Tin Plated  |                | 1061   | 24 AWG      | 11 / 0.16mm            | 0.221mm <sup>2</sup>     | 1.1mm                |
|                       |                  |             |                |  | 26 AWG      | 7 / 0.16mm             | 0.141mm <sup>2</sup>     | 1.0mm                |
| DF11A-2428SC (Note 1) | CL0543-0635-1-00 | Tin Plated  | 1061           | 28 AWG   | 7 / 0.127mm | 0.089mm <sup>2</sup>   | 0.9mm                    |                      |
|                       |                  |             |                | 1007   | 24 AWG      | 11 / 0.16mm            | 0.221mm <sup>2</sup>     | 1.45mm               |
| DF11-2428SCA          | CL0543-0551-3-00 | Gold Plated | 1007           |  | 26 AWG      | 7 / 0.16mm             | 0.141mm <sup>2</sup>     | 1.3mm                |
|                       |                  |             |                | 28 AWG   | 7 / 0.127mm | 0.089mm <sup>2</sup>   | 1.2mm                    |                      |
| DF11-30SC             | CL0543-0606-3-00 | Tin Plated  | 1061           | 30 AWG   | 7 / 0.1mm   | 0.055mm <sup>2</sup>   | 0.8mm                    |                      |
| DF11-30SCA            | CL0543-0608-9-00 | Gold Plated | 1061           | 30 AWG   | 7 / 0.1mm   | 0.055mm <sup>2</sup>   | 0.8mm                    |                      |

Note 1 : DF11A-2428SC is the low insertion/extraction tin plated type.

Note 2 : When crimping using a hand crimping tool, only the above wires are applicable.

Note 3 : The strip length is a reference value. Adjust so that each dimension after crimping meets the specified value.

Refer to the Crimp Quality Standard (ETAD-H0773-00) for details.

## Crimping Contact for In-line Plug

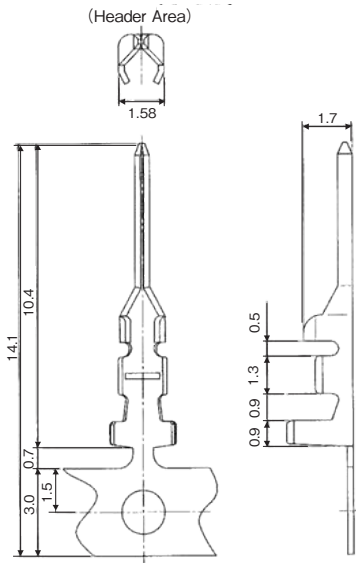

### ◆ Reel Contact (Applicable Tool : Applicator)

| Part No.        | HRS No.          | Finish      | Purchase Unit      | Applicable Wire (Tin Plated Annealed Copper Wire) (Note 1) |           |                        |                          |                   |
|-----------------|------------------|-------------|--------------------|--|-----------|------------------------|--------------------------|-------------------|
|                 |                  |             |                    | UL   | Wire Size | Standed Wire Conductor | Calculated Cross-section | Jacket Outer Dia. |
| DF11-EP2428PCF  | CL0543-0615-4-00 | Tin Plated  | 10,000pcs per reel | 1061, 1007   | 24 AWG    | 11 / 0.16mm            | 0.221mm <sup>2</sup>     | 0.9 to 1.45mm     |
|                 |                  |             |                    |  | 26 AWG    | 7 / 0.16mm             | 0.141mm <sup>2</sup>     |                   |
|                 |                  |             |                    |  | 28 AWG    | 7 / 0.127mm            | 0.089mm <sup>2</sup>     |                   |
| DF11-EP2428PCFA | CL0543-0617-0-00 | Gold Plated | 10,000pcs per reel | 1061, 1007   | 24 AWG    | 11 / 0.16mm            | 0.221mm <sup>2</sup>     | 0.9 to 1.45mm     |
|                 |                  |             |                    |  | 26 AWG    | 7 / 0.16mm             | 0.141mm <sup>2</sup>     |                   |
|                 |                  |             |                    |  | 28 AWG    | 7 / 0.127mm            | 0.089mm <sup>2</sup>     |                   |

● Strip Length : 1.9 to 2.3mm

Note 1 : Contact your Hirose representative if considering use of non-specified cables.

Note 2 : The strip length is a reference value. Adjust so that each dimension after crimping meets the specified value. Refer to the Crimp Quality Standard (ETAD-H0935-00) for details.

### ◆ Loose Contact (Applicable Tool : Hand Crimping Tool)

| Part No.       | HRS No.          | Finish      | Purchase Unit  | Applicable Wire (Tin Plated Annealed Copper Wire) (Note 1) |           |                        |                          |                   |
|----------------|------------------|-------------|----------------|--|-----------|------------------------|--------------------------|-------------------|
|                |                  |             |                | UL   | Wire Size | Standed Wire Conductor | Calculated Cross-section | Jacket Outer Dia. |
| DF11-EP2428PC  | CL0543-0616-7-00 | Tin Plated  | 100pcs per bag | 1007   | 24 AWG    | 11 / 0.16mm            | 0.221mm <sup>2</sup>     | 1.45mm            |
|                |                  |             |                |  | 26 AWG    | 7 / 0.16mm             | 0.141mm <sup>2</sup>     | 1.3mm             |
|                |                  |             |                |  | 28 AWG    | 7 / 0.127mm            | 0.089mm <sup>2</sup>     | 1.2mm             |
| DF11-EP2428PCA | CL0543-0618-2-00 | Gold Plated | 100pcs per bag | 1007   | 24 AWG    | 11 / 0.16mm            | 0.221mm <sup>2</sup>     | 1.45mm            |
|                |                  |             |                |  | 26 AWG    | 7 / 0.16mm             | 0.141mm <sup>2</sup>     | 1.3mm             |
|                |                  |             |                |  | 28 AWG    | 7 / 0.127mm            | 0.089mm <sup>2</sup>     | 1.2mm             |

Note 1 : When crimping using a hand crimping tool, only the above wires are applicable.

Note 2 : The strip length is a reference value. Adjust so that each dimension after crimping meets the specified value. Refer to the Crimp Quality Standard (ETAD-H0935-00) for details.

## Embossed Carrier Tape Dimensions (JIS-C-0806 Standard)

### ● Straight Pin Header (SMT)

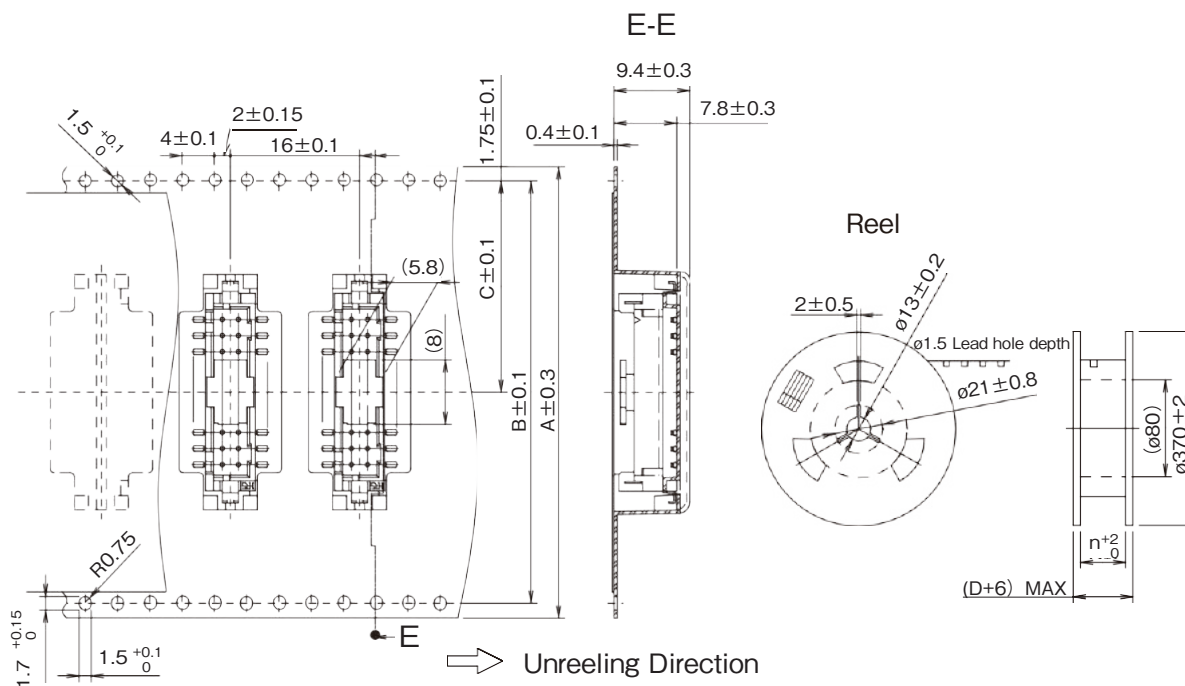

Unit : mm

| Product Type                            | No. of Pos. | A    | B    | C    | D    |
|---|-------------|------|------|------|------|
| DF11CZ-##DP-2V(27)<br>DF11C-##DP-2V(57) | 4 to 8      | 24.0 | -    | 11.5 | 24.4 |
|   | 10 to 12    | 32.0 | 28.4 | 14.2 | 32.4 |
|   | 14 to 22    | 44.0 | 40.4 | 20.2 | 44.4 |
|   | 24 to 32    | 56.0 | 52.4 | 26.2 | 56.4 |
|   | 40          | 72.0 | 68.4 | 34.2 | 72.4 |



# Application Pattern

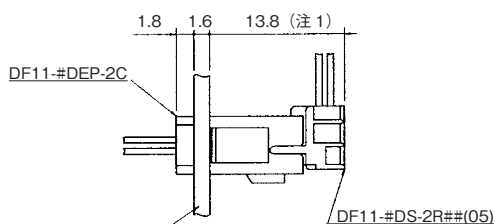
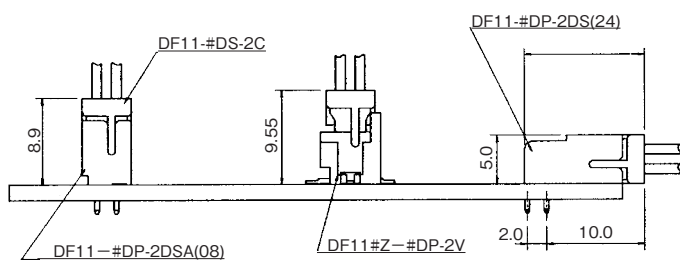
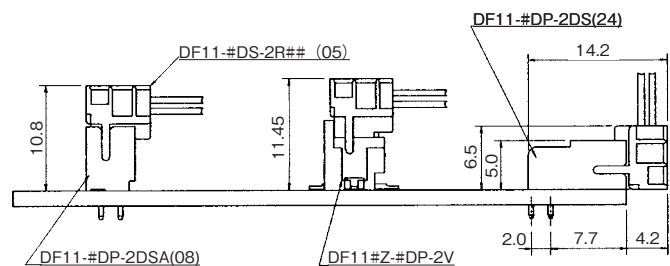

(Note 1) DF11-#DS-2C : 11.9

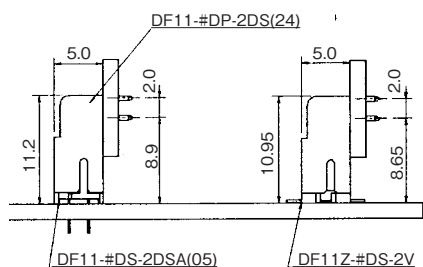
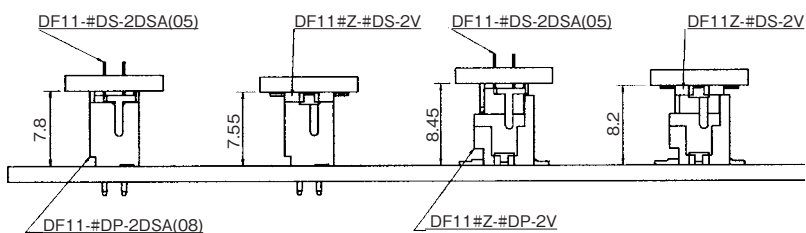
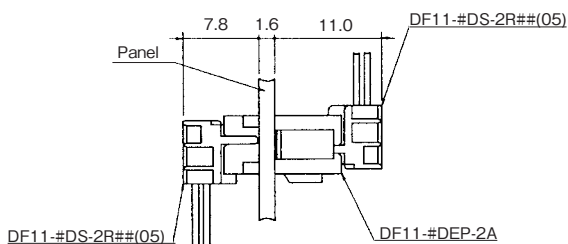

## Applicable Crimping Tool

| Type                    | Part No.              | HRS No.          | Applicable Contact                                 |
|-------------------------|-----------------------|------------------|--|
| Applicator              | AP105-DF11-22S        | CL0901-4529-7-00 | DF11-22SCF<br>DF11-22SCFA(04)                      |
|                         | AP105-DF11-2428S      | CL0901-4511-1-00 | DF11-2428SCF<br>DF11A-2428SCF<br>DF11-2428SCFA(04) |
|                         | AP105-DF11-30S        | CL0901-4532-1-00 | DF11-30SCF<br>DF11-30SCFA(04)                      |
|                         | AP105-DF11-EP2428P    | CL0901-4528-4-00 | DF11-EP2428PCF<br>DF11-EP2428PCFA                  |
| Press                   | CM-105C               | CL0901-0001-0-00 | —  |
| Hand Crimping Tool      | HT801/DF11-22S(A)     | CL0550-0407-5-00 | DF11-22SC<br>DF11-22SCA                            |
|                         | HT801/DF11-2428S(A)   | CL0550-0403-4-00 | DF11-2428SC<br>DF11A-2428SC<br>DF11-2428SCA        |
|                         | HT801/DF11-30S(A)     | CL0550-0408-8-00 | DF11-30SC<br>DF11-30SCA                            |
|                         | HT801/DF11-EP2428P(A) | CL0550-0409-0-00 | DF11-EP2428PC<br>DF11-EP2428PCA                    |
| Contact Extraction Tool | DF-C-PO(B)            | CL0550-0179-2-00 | DF11(A)-###SC(F)(A)(##)<br>DF11-EP2428PC(F)(A)     |

Note 1 : Please do the crimping operations according to the table in the Crimp Quality Standard (ETAD-H0773-00, ETAD-H0935-00).

Note 2 : Problems with tools other than those specified by Hirose are outside the scope of warranty.

## Crimping

### ■ Items required prior to starting crimping

The work-related documents shown below are required before starting harness assembly.

(The ● mark represents required documents.)

Please contact your Hirose sales representative if you do not have these documents.

| Document Title                                | Description  | Automatic Crimping Machine | Hand Crimping Tool | Remarks  |
|---|--|----------------------------|--------------------|--|
| Crimping Machine Main Unit Instruction Manual | Explanation of Main Press Machine Unit                     | ●                          | -                  | Bundled with purchase of main press machine unit |
| Applicator Spare Parts Identification         | Explanation for Applicator Installation                    | ●                          | -                  | Bundled with purchase of applicator.             |
| Crimp Conditions                              | Standard Crimp Height and Tensile Strength Values          | ●                          | -                  |  |
| Crimp Quality Standards                       | Various Standards for Crimping Conditions                  | ●                          | -                  |  |
| Operating Instructions for Hand Tool          | Crimp Height, Tensile Strength, and Other Inspection Items | -                          | ●                  | Bundled with purchase of hand tool.              |
| Harness Procedure Manual ETAD-H0965-00        | Harness Procedure  | ●                          | ●                  | Ask a Hirose sales personnel to provide them.    |

### ■ Tools

Use tools specified by Hirose for crimping.

\*Crimping performed with tools other than those designated should be avoided as it may result in contact failure, disconnection of cable, etc.

\*Operating instructions are available for the crimping machine and the applicator.

Be sure to carefully read the operating instructions manual before beginning work.

### ■ Applicable Cables

Check that the cables to be used are within the applicable range.

If you intend to use a cable other than those recommended, contact a sales representative.

#### [Precautions]

- Cables applicable to crimping connectors are tin-plated stranded soft-copper wire.
- Avoid crimping solid wire, wires with polyester threads or tin coated wires.
- Avoid crimping two cables together.
- The crimp height setting values (Note 1) may vary between tin-plated and gold-plated terminals even if the same electric wires are used.
- The crimp height setting values (Note 1) may vary depending on the difference in the core wire configuration even if the computed cross-sectional area is the same.

Note 1 : The crimp height is an important item that determines crimping quality. We execute crimping tests for each electric wire to ensure the optimal value for the crimp height with high precision, thereby ensuring optimal setup values.

## Precautions

### 1. Recommended Temperature Profile (SMT)

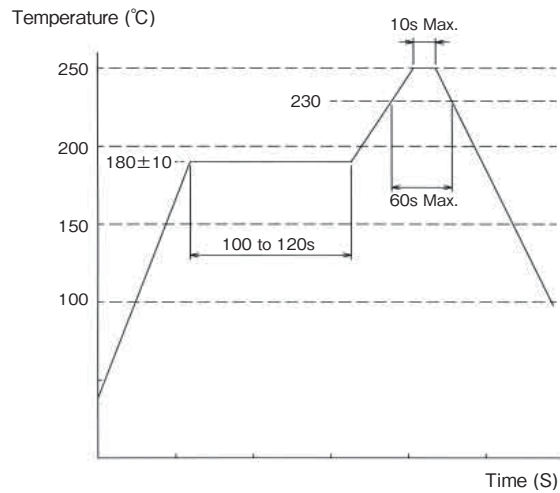

Note 1 : Up to 2 cycles of Reflow soldering are possible under the same conditions, provided that there is a return to normal temperature between the first and second cycle.

Note 2 : The temperature profile indicates the board surface temperature of the contact leads.

Note 3 : This reflow profile is for the connectors packaged in embossed tape (reel), with desiccant in the package. (Within 168 hours of opening)

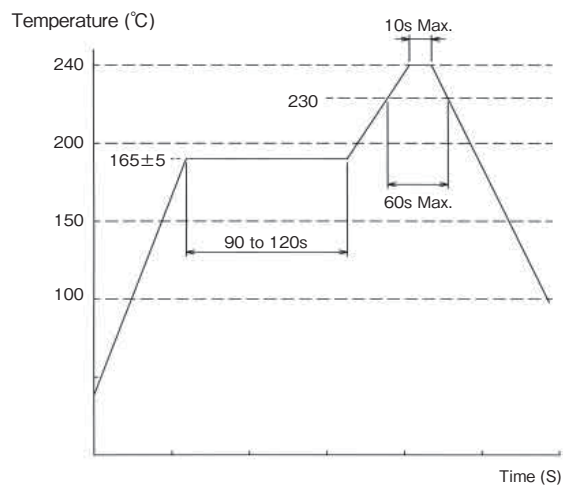

Note 4 : Reflow temperature conditions for embossed packaged products without desiccant and for embossed packaged products with desiccant that have been opened 168 hours ago or longer.



|   |  |
|---|--|
| 2. Recommended Manual Soldering Condition (SMT)   | Soldering iron temperature: $290 \pm 10^{\circ}\text{C}$ , Soldering time: Within 2 seconds  |
| 3. Recommended Screen Thickness (SMT)             | 0.15 to 0.2mm  |
| 4. Board Warpage (SMT)                            | Based on the both connector edges, 0.03mm Max. is allowed in the connector center area.  |
| 5. Recommended Soldering Condition (Through-hole) | Flow : $250 \pm 5^{\circ}\text{C}$ for 10 seconds<br>Manual soldering : Soldering iron temperature $290 \pm 10^{\circ}\text{C}$ for 2 seconds  |
| 6. Cleaning Condition                             | Refer to the "Wire-to-Board Connector Use Handbook".   |
| 7. Connection Condition                           | Refer to the "Wire-to-Board Connector Use Handbook".   |
| 8. Precautions                                    | <ul style="list-style-type: none"> <li>■ When inserting the crimp terminal into the IDC socket, do not insert diagonally in order to maintain performance reliability.</li> <li>■ Refer to the DF11 Series Cable Assembly Procedure (ETAD-H0965-00), DF11#-##SC##(##) Crimp Quality Standard (ETAD-H0773-00), DF11#-EP####PC##(##) (ETAD-H0935-00) and Crimp Condition for the cable assembly procedures.</li> <li>■ Please refrain from insertion and removal when not mounted to the board as it may result in damage or deformation of the contacts.</li> <li>■ Do not remove the product by holding the cable as it may result in damage.</li> <li>■ When soldering by hand do not apply flux that may result in flux rising.</li> <li>■ There may be slight variation in the mold coloration based on production lot but this does not affect the product performance.</li> </ul> |
| 9. Handling Instructions                          | <p>Refer to the following documents when handling this product.</p> <ul style="list-style-type: none"> <li>■ Crimp Quality Standard (ETAD-H0773-00, ETAD-H0935-00)</li> <li>■ Cable Assembly Procedure (ETAD-H0965-00)</li> <li>■ Wire-to-Board Connector Use Handbook</li> </ul>  |

## While taking in consideration

Specifications mentioned in this catalog are reference values.

When considering to order or use this product, please confirm the "Drawing" and "Product Specifications" sheets.

Use an appropriate cable when using the connector in combination with cables.

If considering usage of a non-specified cable, please contact your sales representative.

If assembly process is done by jigs & tools which are not identified by Hirose assurance will not be given.

Please consult with your Hirose sales representative if you are planning to use the product for any of the following applications. (Automotive, medical, public infrastructure, aerospace/defense, etc.)

Hirose will consider the validity of the warranty depending on the conditions.