



The Future of Analog IC Technology®

## DESCRIPTION

The MP1496S is a high-frequency, synchronous, rectified, step-down, switch-mode converter with built-in power MOSFETs. It offers a very compact solution to achieve a 2A continuous output current with excellent load and line regulation over a wide input supply range. The MP1496S has synchronous mode operation for higher efficiency over the output-current-load range.

Current-mode operation provides a fast transient response and eases loop stabilization.

Protective features include over-current protection and thermal shut down and external SS control.

The MP1496S requires a minimal number of readily-available standard external components, and is available in a space-saving 8-pin TSOT23 package.

# MP1496S

## High-Efficiency, 2A, 16V, 500kHz Synchronous, Step-Down Converter

## FEATURES

- Wide 4.5V to 16V Operating Input Range
- 150mΩ/70mΩ Low- $R_{DS(ON)}$  Internal Power MOSFETs
- Proprietary Switching-Loss-Reduction Technique
- High-Efficiency Synchronous Mode Operation
- Fixed 500kHz Switching Frequency
- Can Synchronize with a 300kHz-to-2MHz External Clock
- Externally Programmable Soft-Start
- OCP Protection and Hiccup
- Thermal Shutdown
- Output Adjustable Starting from 0.8V
- Available in an 8-pin TSOT23 Package

## APPLICATIONS

- Notebook Computers and I/O Power
- Digital Set-Top Boxes
- Flat-Panel Television and Monitors
- Distributed Power Systems

All MPS parts are lead-free and adhere to the RoHS directive. For MPS green status, please visit MPS website under Products, Quality Assurance page.

"MPS" and "The Future of Analog IC Technology" are registered trademarks of Monolithic Power Systems, Inc.

## TYPICAL APPLICATION

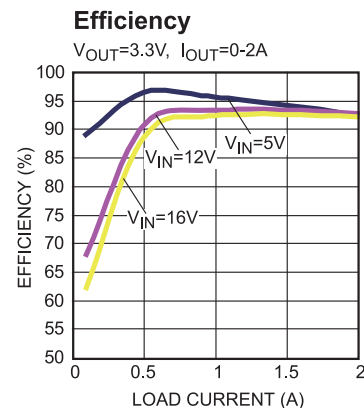
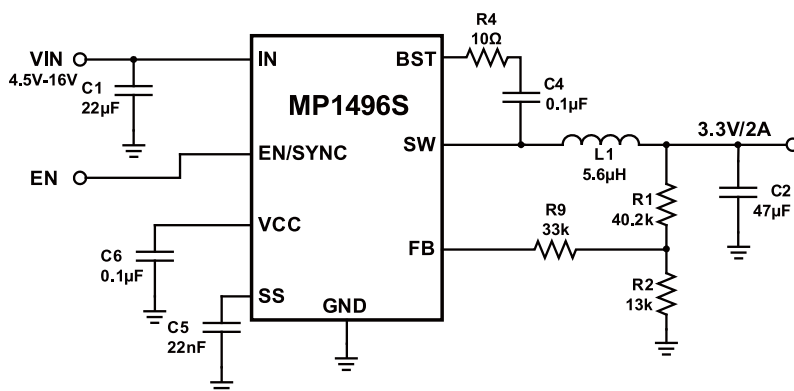

### ORDERING INFORMATION

Part Number*	Package	Top Marking
MP1496SGJ	TSOT23-8	AJR

\* For Tape & Reel, add suffix -Z (e.g. MP1496SGJ-Z).

### PACKAGE REFERENCE

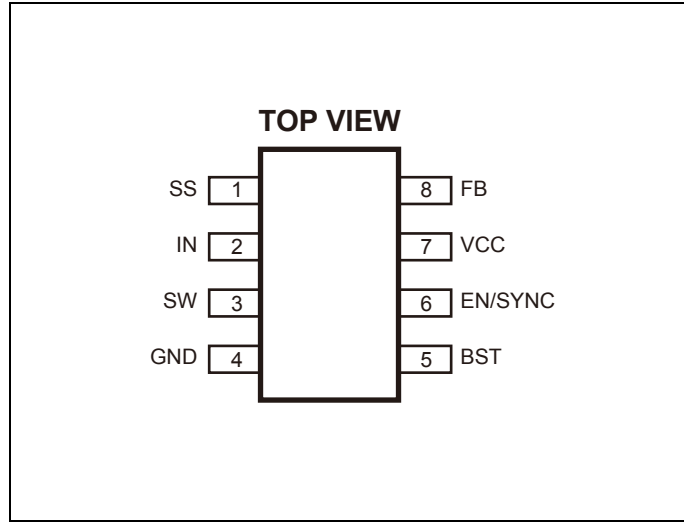

#### ABSOLUTE MAXIMUM RATINGS <sup>(1)</sup>

$V_{IN}$ .....	-0.3V to 17V
$V_{SW}$ ...-0.3V (-5V for <10ns) to 17V (19V for 5ns)	
$V_{BST}$ .....	$V_{SW}+6V$
All Other Pins .....	-0.3V to 6V <sup>(2)</sup>
Continuous Power Dissipation ( $T_A = +25^{\circ}C$ ) <sup>(3)</sup>	1.25W
Junction Temperature .....	150°C
Lead Temperature .....	260°C
Storage Temperature.....	-65°C to 150°C

#### Recommended Operating Conditions <sup>(4)</sup>

Supply Voltage $V_{IN}$ .....	4.5V to 16V
Output Voltage $V_{OUT}$ .....	0.8V to $V_{IN} \times D_{MAX}$
Operating Junction Temp. ( $T_J$ ).	-40°C to +125°C

#### Thermal Resistance

TSOT23-8	$\theta_{JA}$	$\theta_{JC}$
EV1496S-J-00A.....	66 .....	23... °C/W
JESD51-7 <sup>(5)</sup> .....	100 .....	55... °C/W

#### Notes:

- Exceeding these ratings may damage the device.
- About the details of EN pin's ABS MAX rating, please refer to Page 9, Enable section.
- The maximum allowable power dissipation is a function of the maximum junction temperature  $T_J$  (MAX), the junction-to-ambient thermal resistance  $\theta_{JA}$ , and the ambient temperature  $T_A$ . The maximum allowable continuous power dissipation at any ambient temperature is calculated by  $P_D$  (MAX) =  $(T_J$  (MAX)- $T_A$ )/ $\theta_{JA}$ . Exceeding the maximum allowable power dissipation will cause excessive die temperature, and the regulator will go into thermal shutdown. Internal thermal shutdown circuitry protects the device from permanent damage.
- The device is not guaranteed to function outside of its operating conditions.
- High Effective Thermal Conductivity Test Board for Leaded Surface Mount Package.

## ELECTRICAL CHARACTERISTICS

$V_{IN} = 12V$ ,  $T_A = 25^{\circ}C$ , unless otherwise noted.

Parameter	Symbol	Condition	Min	Typ	Max	Units
Supply Current (Shutdown)	$I_{IN}$	$V_{EN} = 0V$			1	$\mu A$
Supply Current (Quiescent)	$I_q$	$V_{EN} = 2V$ , $V_{FB} = 1V$		0.7	1	mA
HS-Switch ON Resistance	$HS_{RDS-ON}$	$V_{BST-SW}=5V$		150		m $\Omega$
LS-Switch ON Resistance	$LS_{RDS-ON}$	$V_{CC}=5V$		70		m $\Omega$
Switch Leakage	$SW_{LKG}$	$V_{EN} = 0V$ , $V_{SW} = 12V$			1	$\mu A$
Current Limit <sup>(6)</sup>	$I_{LIMIT}$	Under 40% Duty Cycle	3			A
Oscillator Frequency	$f_{SW}$	$V_{FB}=750mV$	410	500	600	kHz
Fold-back Frequency	$f_{FB}$	$V_{FB}<400mV$		0.5		$f_{SW}$
Maximum Duty Cycle	$D_{MAX}$	$V_{FB}=700mV$	90	95		%
Minimum ON Time <sup>(7)</sup>	$T_{ON MIN}$			60		ns
Sync Frequency Range	$f_{SYNC}$		0.3		2	MHz
Feedback Voltage	$V_{FB}$	$T_A=25^{\circ}C$	791	807	823	mV
		$-40^{\circ}C < T_A < 85^{\circ}C$ <sup>(8)</sup>	787	807	827	
Feedback Current	$I_{FB}$	$V_{FB}=820mV$		10	50	nA
EN Rising Threshold	$V_{EN RISING}$		1.1	1.4	1.75	V
EN Falling Threshold	$V_{EN FALLING}$		1	1.25	1.55	V
EN Input Current	$I_{EN}$	$V_{EN}=2V$		2		$\mu A$
		$V_{EN}=0$		0		$\mu A$
EN Turn-Off Delay	$EN_{Td-off}$			8		$\mu s$
$V_{IN}$ Under-Voltage Lockout Threshold-Rising	$INUV_{Vth}$		3.6	3.9	4.2	V
$V_{IN}$ Under Voltage Lockout Threshold-Hysteresis	$INUV_{HYS}$			650		mV
VCC Regulator	$V_{CC}$			5		V
VCC Load Regulation		$I_{CC}=5mA$		3		%
Soft-Start Current	$I_{SS}$			11		$\mu A$
Thermal Shutdown <sup>(7)</sup>				150		$^{\circ}C$
Thermal Hysteresis <sup>(7)</sup>				20		$^{\circ}C$

**Notes:**

- 6) Guaranteed by characterization.
- 7) Guaranteed by design.
- 8) Not tested in production and guaranteed by over-temperature correlation.

## TYPICAL PERFORMANCE CHARACTERISTICS

Performance waveforms are tested on the evaluation board.

$T_A = 25^\circ\text{C}$ , unless otherwise noted.

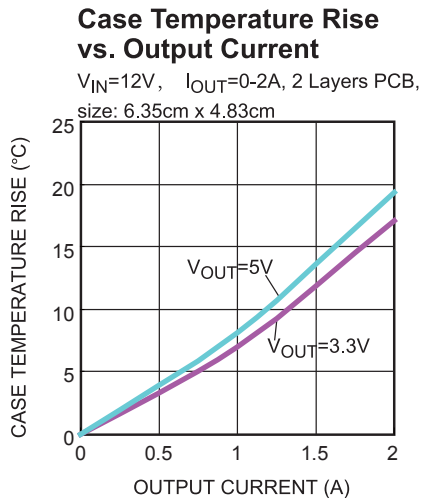
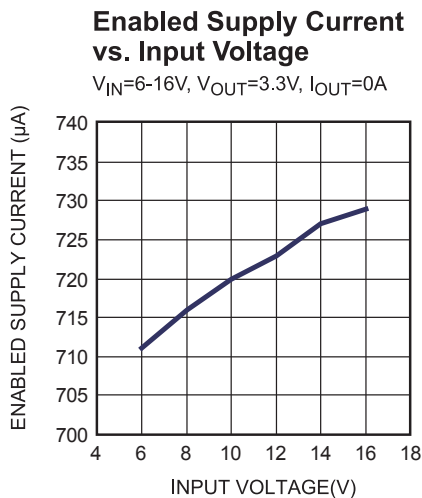
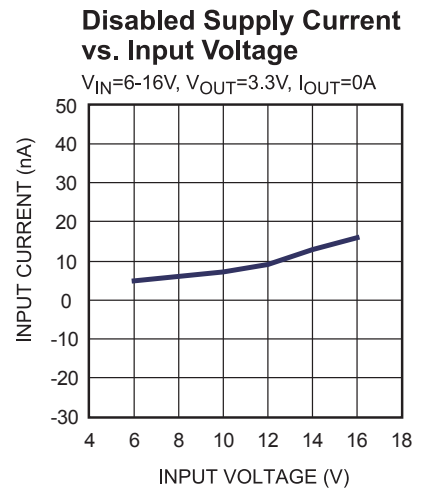
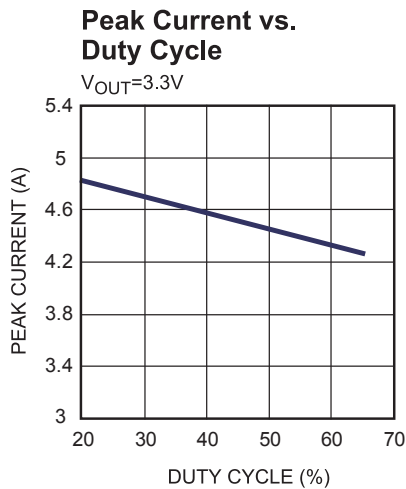
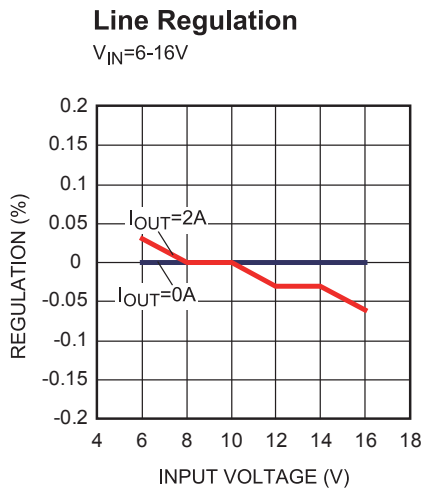
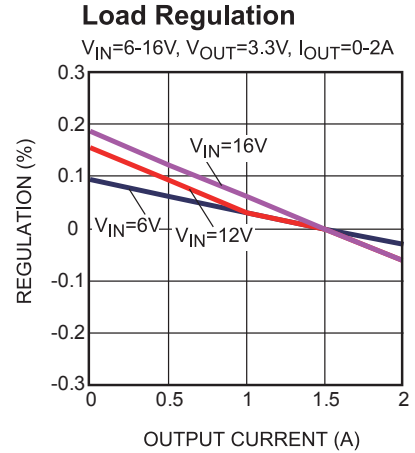
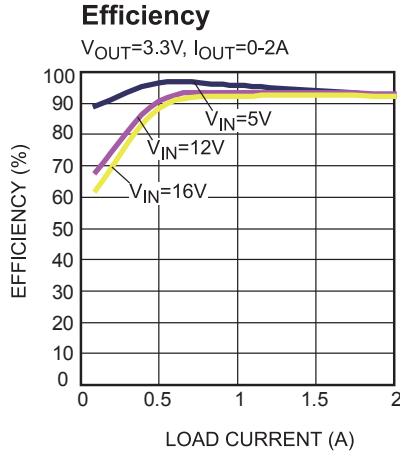
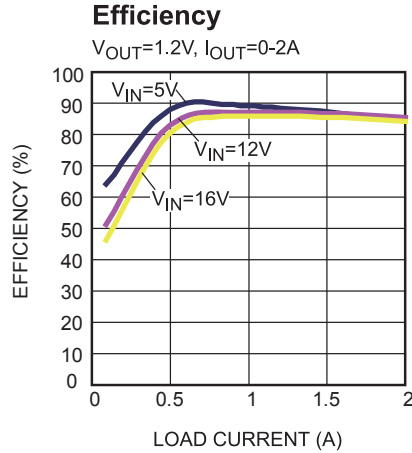

**TYPICAL PERFORMANCE CHARACTERISTICS (continued)**

Performance waveforms are tested on the evaluation board.

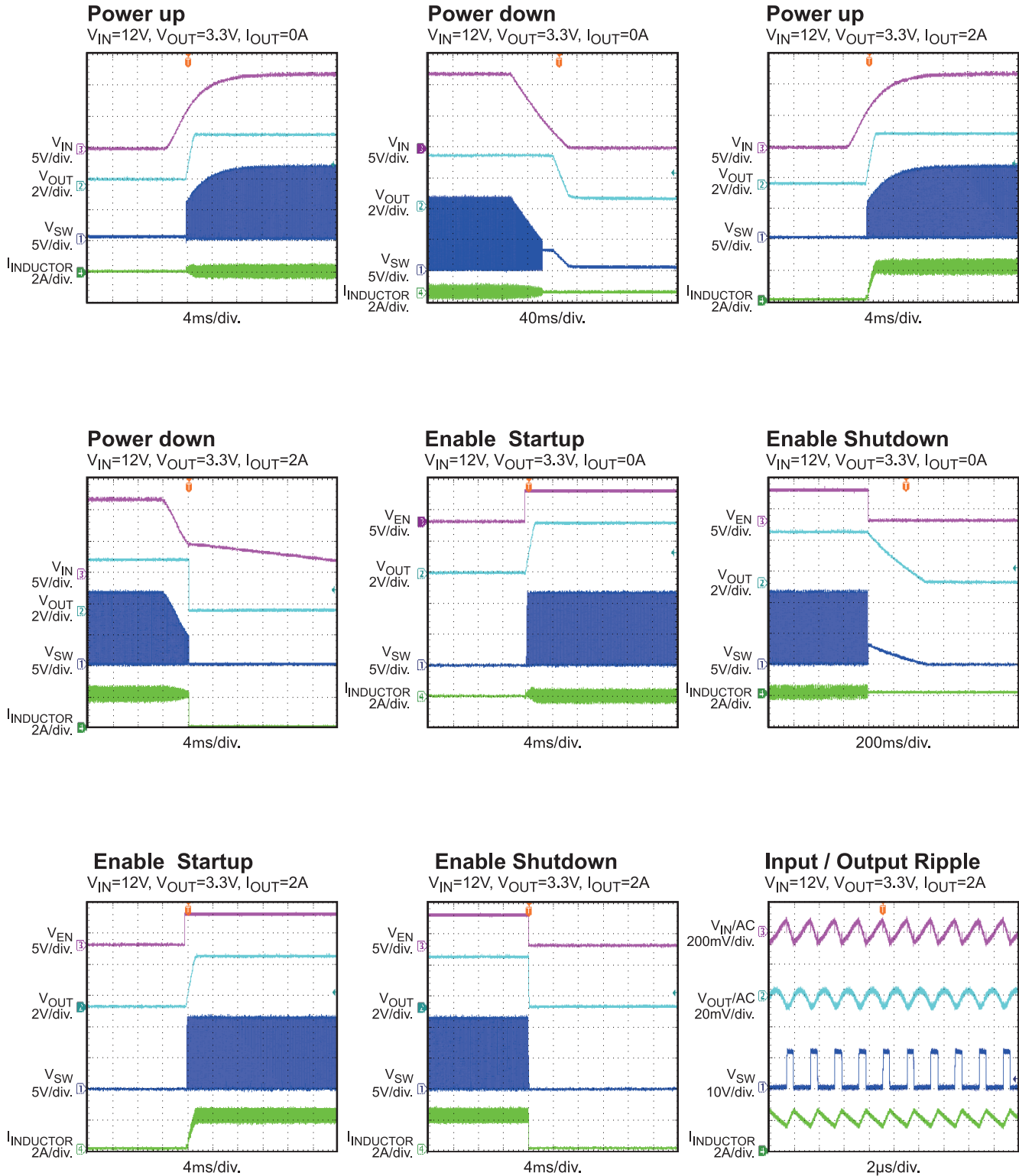
 $T_A = 25^\circ\text{C}$ , unless otherwise noted.

**TYPICAL PERFORMANCE CHARACTERISTICS (continued)**

Performance waveforms are tested on the evaluation board.

 $T_A = 25^\circ\text{C}$ , unless otherwise noted.

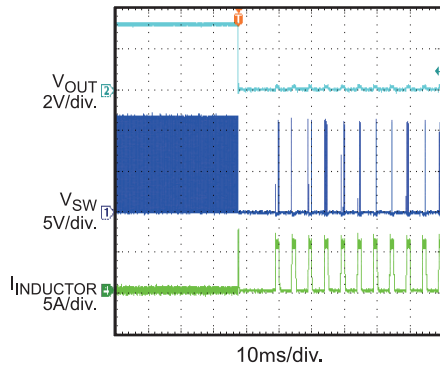
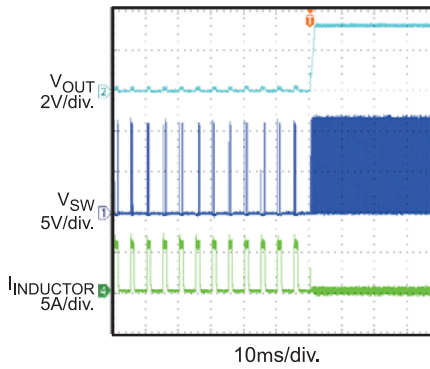
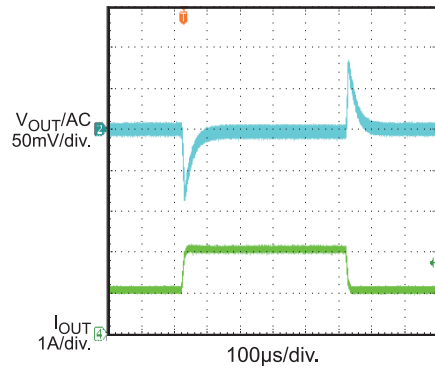
**Short Circuit Entry**
 $V_{IN}=12\text{V}, V_{OUT}=3.3\text{V}, I_{OUT}=0\text{A}$ 

**Short Circuit Recovery**
 $V_{IN}=12\text{V}, V_{OUT}=3.3\text{V}, I_{OUT}=0\text{A}$ 

**Transient Response**
 $V_{IN}=12\text{V}, V_{OUT}=3.3\text{V}, I_{OUT}=1-2\text{A}, 1\text{A}/\mu\text{s}$ 

## PIN FUNCTIONS

Package Pin #	Name	Description
1	SS	Soft-Start. Connect an external capacitor to program the soft start time for the switch mode regulator.
2	IN	Supply Voltage. The MP1496S operates from a 4.5V-to-16V input rail. C1 decouples the input rail. Use wide PCB trace to make the connection.
3	SW	Switch Output. Connect using a wide PCB trace.
4	GND	System Ground. Reference ground of the regulated output voltage. Use special care in PCB layout: Connect to GND with copper and vias.
5	BST	Bootstrap. Connect a capacitor between SW and BST pins to form a floating supply across the high-side switch driver. A 10Ω resistor placed between SW and BST cap is strongly recommended to reduce SW spike voltage.
6	EN/SYNC	Enable/Synchronize. EN high to enable the MP1496S. Apply an external clock to EN/SYNC pin to change the switching frequency.
7	VCC	Bias Supply. Decouple with 0.1μF-to-0.22μF cap. The capacitance should not exceed 0.22μF. VCC capacitor should be put closely to VCC pin and GND pin.
8	FB	Feedback. Connect to the tap of an external resistor divider from the output to GND to set the output voltage. The frequency fold-back comparator lowers the oscillator frequency when the FB voltage is below 400mV to prevent current-limit runaway during a short-circuit fault.





## OPERATION

The MP1496S is a high-frequency, synchronous, rectified, step-down, switch-mode converter with built-in power MOSFETs. It offers a very compact solution to achieve 2A continuous output current with excellent load and line regulation over a wide input supply range,

The MP1496S operates in a fixed-frequency, peak-current-control mode to regulate the output voltage. An internal clock initiates a PWM cycle. The integrated high-side power MOSFET turns on and remains on until its current reaches the value set by the COMP voltage. When the power switch is off, it remains off until the next clock cycle starts. If the current in the power MOSFET does not reach the COMP set current value within 95% of one PWM period, the power MOSFET turns off.

### Internal Regulator

The 5V internal regulator powers most of the internal circuitries. This regulator takes the  $V_{IN}$  input and operates in the full  $V_{IN}$  range. When  $V_{IN}$  exceeds 5.0V, the output of the regulator is in full regulation. When  $V_{IN}$  is less than 5.0V, the output decreases and requires a 0.1 $\mu$ F ceramic decoupling capacitor.

### Error Amplifier

The error amplifier compares the FB pin voltage against the internal 0.8V reference (REF) and outputs a COMP voltage, which controls the power MOSFET current. The optimized internal compensation network minimizes the external component counts and simplifies the control loop design.

### Enable/SYNC Control

EN is a digital control pin that turns the regulator on and off. Drive EN high to turn on the regulator, drive it low to turn it off. An internal 1M $\Omega$  resistor from EN to GND allows EN to float to shut down the chip.

A 6.5V-series Zener diode clamps the EN pin internally as shown in Figure 2. The EN input pin can then connect through a pullup resistor to any voltage connected to the IN pin: The pullup resistor limits the EN input current to less than 100 $\mu$ A.

For example, with  $V_{IN}=12V$ ,  $R_{PULLUP} \geq [(12V - 6.5V) \div 100\mu A = 55k\Omega]$ .

Directly connecting the EN pin a voltage source without any pullup resistor requires limiting the voltage source amplitude to below 6.5V to prevent damaging the Zener diode.

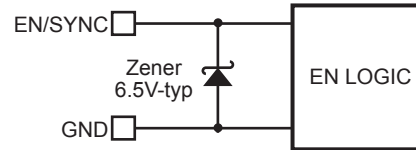

**Figure 2: Zener Diode Circuit**

For external clock synchronization, connect a clock with a frequency range between 300kHz and 2MHz 2ms after setting the output voltage: The internal clock's rising edge synchronizes with the external clock rising edge. Select an external clock signal with a pulse width less than 1.7 $\mu$ s.

### Under-Voltage Lockout

Under-voltage lockout (UVLO) protects the chip from operating at an insufficient supply voltage. The MP1496S UVLO comparator monitors the output voltage of the internal regulator, VCC. The UVLO rising threshold is about 3.9V while its falling threshold is 3.25V.

### External Soft-Start

Adjust the soft-start time by connecting a capacitor from SS pin to ground. When the soft-start begins, an internal 11 $\mu$ A current source charges the external capacitor. During soft-start, the soft-start capacitor connects to the non-inverting input of the error amplifier. The soft-start period continues until the voltage on the soft-start capacitor exceeds the 0.8V reference. Then the non-inverting amplifier uses the reference voltage takes as the input. Use the following equation to calculate the soft-start time:

$$t_{ss}(\text{ms}) = \frac{0.8V \times C_{ss}(\text{nF})}{11\mu A}$$

### Over-Current Protection and Hiccup

The MP1496S has a cycle-by-cycle over-current limit when the inductor current peak exceeds the set current-limit threshold. Meanwhile, output voltage drops until FB falls below the under-voltage (UV) threshold—typically 50% below the reference. Once UV triggers, the MP1496S enters hiccup mode to periodically restart the part. This protection mode is especially useful when the output is dead-shortened to ground. This greatly reduces the average short circuit current, alleviates thermal issues, and protects the regulator. The MP1496S exits hiccup mode once the over current condition is removed.

### LS-FET Negative Current Limit Protection

To prevent LS-FET current goes too negative, The MP1496S will sense the LS-FET current during LS-FET turn on period. It provides cycle-by-cycle negative current limit protection when the inductor valley current is lower than the set negative current limit. Internal 500kHz or 250kHz (fold-back frequency) clock initiates the PWM cycle, If LS-FET negative current limit is triggered before internal clock comes, LS-FET will turn off and wait for internal clock to turn on HS-FET. In this case, MP1496S will work at DCM mode. If LS-FET negative current limit is not triggered in a clock cycle, MP1496S works at CCM mode. During soft start period, the LS-FET negative current limit is gradually decrease from 0A(typical) to -1A (typical).

### Thermal Shutdown

Thermal shutdown prevents the chip from operating at exceedingly high temperatures. When the silicon die temperature exceeds 150°C, the whole chip shuts down. When the temperature drops below its lower threshold—typically 130°C—the chip is enabled again.

### Floating Driver and Bootstrap Charging

An external bootstrap capacitor powers the floating power MOSFET driver. This floating driver has its own UVLO protection with a rising threshold of 2.2V and a hysteresis of 150mV. The bootstrap capacitor voltage is regulated internally by  $V_{IN}$  through D1, M1, C4, L1 and C2 (see Figure 3). If  $(V_{IN}-V_{SW})$  exceeds 5V, U1 will regulate M1 to maintain a 5V BST voltage across C4. A 10Ω resistor placed between SW and BST cap is strongly recommended to reduce SW spike voltage.

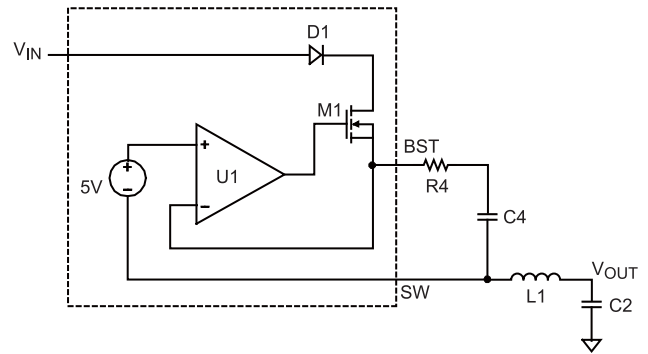

**Figure 3: Internal Bootstrap Startup and Shutdown Charging Circuit**

If both  $V_{IN}$  and EN exceed their appropriate thresholds, the chip starts. The reference block starts first, generating stable reference voltages and currents, and then the internal regulator is enabled. The regulator provides stable supply for the remaining circuitries.

Three events can shut down the chip: EN low,  $V_{IN}$  low, and thermal shutdown. In shutdown, the signaling path is first blocked to avoid any fault triggering. The COMP voltage and the internal supply rail are then pulled down. The floating driver is not subject to this shutdown command.

## APPLICATION INFORMATION

### Setting the Output Voltage

The external resistor divider sets the output voltage (see the Typical Application on page 1). The feedback resistor R1 sets the feedback loop bandwidth. R2 is then given by:

$$R2 = \frac{R1}{\frac{V_{OUT}}{0.807V} - 1}$$

The T-type network shown in Figure 4 is highly recommended.

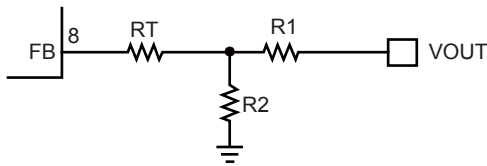

**Figure 4: T-Type Network**

Table 1 lists the recommended T-type resistor values for common output voltages.

**Table 1: Resistor Selection for Common Output Voltages**

V <sub>OUT</sub> (V)	R1 (kΩ)	R2 (kΩ)	Rt (kΩ)
1.0	20.5	82	82
1.2	30.1	60.4	82
1.8	40.2	32.4	56
2.5	40.2	19.1	33
3.3	40.2	13	33
5	40.2	7.68	33

### Selecting the Inductor

Use a 1μH-to-10μH inductor with a DC current rating of at least 25% percent higher than the maximum load current for most applications. Select an inductor with a DC resistance less than 15mΩ for highest efficiency. For most designs, the inductance value can be derived from the following equation.

$$L_1 = \frac{V_{OUT} \times (V_{IN} - V_{OUT})}{V_{IN} \times \Delta I_L \times f_{OSC}}$$

Where  $\Delta I_L$  is the inductor ripple current.

Choose an inductor ripple current to be approximately 30% of the maximum load current. The maximum inductor peak current is:

$$I_{L(MAX)} = I_{LOAD} + \frac{\Delta I_L}{2}$$

Use a larger inductance for improved light-load efficiency.

### Selecting the Input Capacitor

The input current to the step-down converter is discontinuous, and therefore requires a capacitor to supply the AC current to the step-down converter while maintaining the DC-input voltage. Use low-ESR capacitors for best performance, especially ceramic capacitors with X5R or X7R dielectrics for their low ESR and small temperature coefficients. For most applications, use a 22μF capacitor.

Since the input capacitor (C1) absorbs the input switching current, it requires an adequate ripple current rating. Estimate the RMS current in the input capacitor with:

$$I_{C1} = I_{LOAD} \times \sqrt{\frac{V_{OUT}}{V_{IN}} \times \left(1 - \frac{V_{OUT}}{V_{IN}}\right)}$$

The worse case condition occurs at  $V_{IN} = 2V_{OUT}$ , where:

$$I_{C1} = \frac{I_{LOAD}}{2}$$

For simplification, choose an input capacitor with an RMS current rating greater than half the maximum load current.

The input capacitor can be electrolytic, tantalum or ceramic. When using electrolytic or tantalum capacitors, place a small, high quality ceramic capacitor—e.g. 0.1μF—as close to the IC as possible. When using ceramic capacitors, make sure that they have enough capacitance to provide sufficient charge to prevent excessive voltage ripple at input. The input voltage ripple caused by capacitance can be estimated by:

$$\Delta V_{IN} = \frac{I_{LOAD}}{f_s \times C1} \times \frac{V_{OUT}}{V_{IN}} \times \left(1 - \frac{V_{OUT}}{V_{IN}}\right)$$

### Selecting the Output Capacitor

The output capacitor (C2) maintains the DC output voltage. Use ceramic, tantalum, or low ESR electrolytic capacitors. For best results, use low-ESR capacitors to keep the output voltage ripple low. The output voltage ripple can be estimated by:

$$\Delta V_{OUT} = \frac{V_{OUT}}{f_s \times L_1} \times \left(1 - \frac{V_{OUT}}{V_{IN}}\right) \times \left(R_{ESR} + \frac{1}{8 \times f_s \times C2}\right)$$

Where  $L_1$  is the inductor value, and  $R_{ESR}$  is the ESR value of the output capacitor.

For ceramic capacitors, the capacitance dominates the impedance at the switching frequency, and causes most of the output voltage ripple. For simplification, the output voltage ripple can be estimated by:

$$\Delta V_{OUT} = \frac{V_{OUT}}{8 \times f_s^2 \times L_1 \times C2} \times \left(1 - \frac{V_{OUT}}{V_{IN}}\right)$$

For tantalum or electrolytic capacitors, the ESR dominates the impedance at the switching frequency. For simplification, the output ripple can be approximated to:

$$\Delta V_{OUT} = \frac{V_{OUT}}{f_s \times L_1} \times \left(1 - \frac{V_{OUT}}{V_{IN}}\right) \times R_{ESR}$$

The characteristics of the output capacitor also affect the stability of the regulation system. The MP1496S can be optimized for a wide range of capacitance and ESR values.

### External Bootstrap Diode

An external bootstrap diode can improve the regulator efficiency, given the following applicable conditions:

- $V_{OUT}$  is 5V or 3.3V; and
- Duty cycle is high:  $D = \frac{V_{OUT}}{V_{IN}} > 65\%$

In these cases, use an external BST diode from the VCC pin to BST pin, as shown in Figure 5.

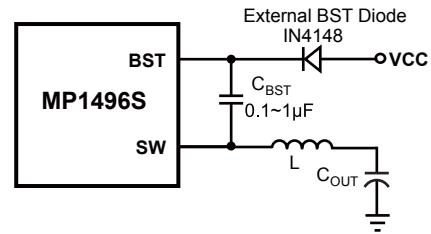

**Figure 5: Optional External Bootstrap Diode to Enhance Efficiency**

The recommended external BST diode is IN4148, and the BST capacitor value is 0.1µF to 1µF.

### PC Board Layout<sup>(9)</sup>

PCB layout is very important to achieve stable operation especially for VCC capacitor and input capacitor placement. For best results, follow these guidelines:

- 1) Use large ground plane directly connect to GND pin. Add vias near the GND pin if bottom layer is ground plane.
- 2) Place the VCC capacitor to VCC pin and GND pin as close as possible. Make the trace length of VCC pin-VCC capacitor anode-VCC capacitor cathode-chip GND pin as short as possible.
- 3) Place the ceramic input capacitor close to IN and GND pins. Keep the connection of input capacitor and IN pin as short and wide as possible.
- 4) Route SW, BST away from sensitive analog areas such as FB. It's not recommended to route SW, BST trace under chip's bottom side.
- 5) Place the T-type feedback resistor R9 close to chip to ensure the trace which connects to FB pin as short as possible

#### Notes:

- 9) The recommended layout is based on the Figure 6 Typical Application circuit on the last page.

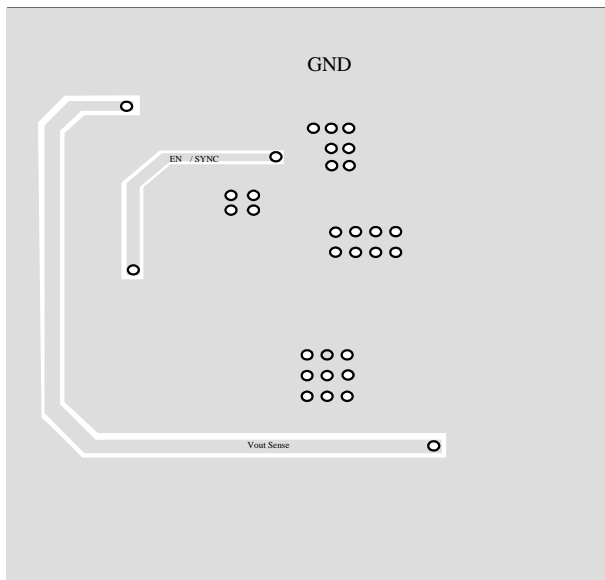
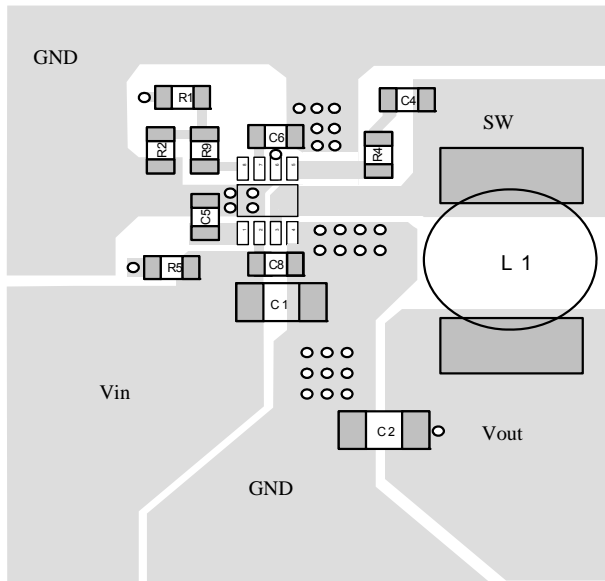

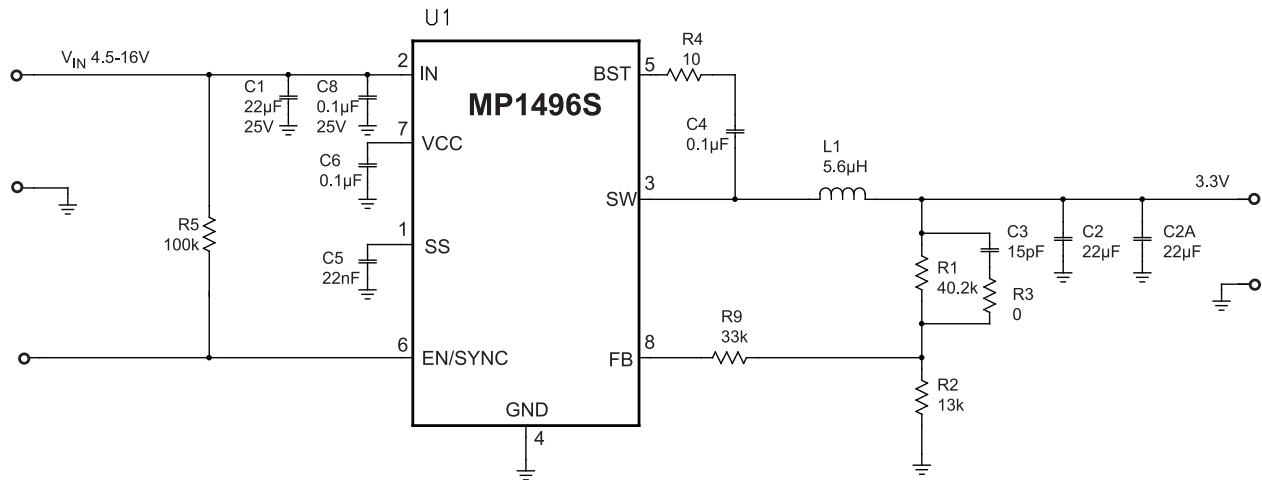
**TYPICAL APPLICATION CIRCUITS**

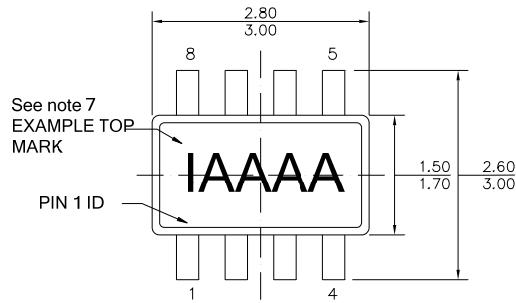
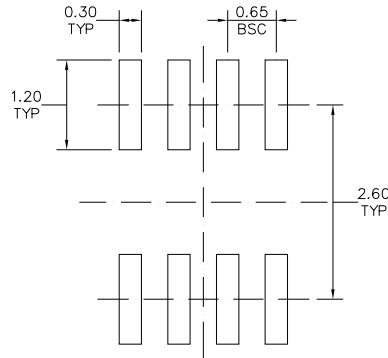
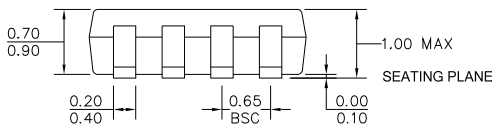
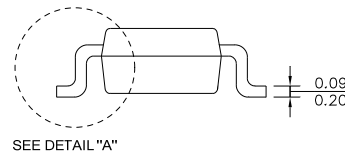
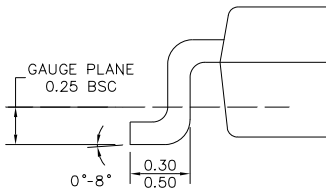
**Figure 6: 12V<sub>IN</sub>, 3.3V/2A**

**PACKAGE INFORMATION**
**TSOT23-8**

**TOP VIEW**

**RECOMMENDED LAND PATTERN**

**FRONT VIEW**

**SIDE VIEW**

**DETAIL "A"**
**NOTE:**

- 1) ALL DIMENSIONS ARE IN MILLIMETERS.
- 2) PACKAGE LENGTH DOES NOT INCLUDE MOLD FLASH, PROTRUSION OR GATE BURR.
- 3) PACKAGE WIDTH DOES NOT INCLUDE INTERLEAD FLASH OR PROTRUSION.
- 4) LEAD COPLANARITY (BOTTOM OF LEADS AFTER FORMING) SHALL BE 0.08 MILLIMETERS MAX.
- 5) JEDEC REFERENCE IS MO-193, VARIATION BA.
- 6) DRAWING IS NOT TO SCALE.
- 7) PIN 1 IS LOWER LEFT PIN WHEN READING TOP MARK FROM LEFT TO RIGHT, (SEE EXAMPLE TOP MARK)

**NOTICE:** The information in this document is subject to change without notice. Users should warrant and guarantee that third party Intellectual Property rights are not infringed upon when integrating MPS products into any application. MPS will not assume any legal responsibility for any said applications.