

IRF8313PbF

HEXFET® Power MOSFET

Applications

- Load Switch
- DC/DC Conversion

Benefits

- Low Gate Charge and Low $R_{DS(on)}$
- Fully Characterized Avalanche Voltage and Current
- 20V V_{GS} Max. Gate Rating
- 100% Tested for R_G
- Lead-Free (Qualified to 260°C Reflow)
- RoHS Compliant (Halogen Free)

Description

The IRF8313PbF incorporates the latest HEXFET Power MOSFET Silicon Technology into the industry standard SO-8 package. The IRF8313PbF has been optimized for parameters that are critical in synchronous buck operation including $R_{ds(on)}$ and gate charge to reduce both conduction and switching losses. The reduced total losses make this product ideal for high efficiency DC-DC converters that power the latest generation of processors for notebook and Netcom applications.

V_{DSS}	$R_{DS(on)}$ max	Qg
30V	15.5mΩ @ $V_{GS} = 10V$	6.0nC

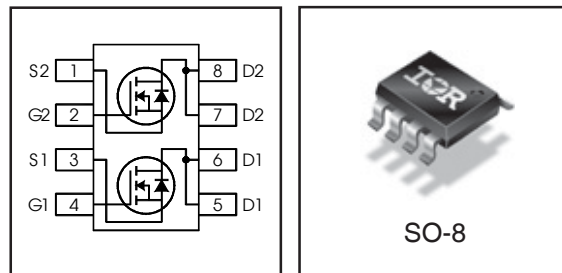

Absolute Maximum Ratings

	Parameter	Max.	Units
V_{DS}	Drain-to-Source Voltage	30	V
V_{GS}	Gate-to-Source Voltage	±20	V
$I_D @ T_A = 25^\circ C$	Continuous Drain Current, $V_{GS} @ 10V$	9.7	A
$I_D @ T_A = 70^\circ C$	Continuous Drain Current, $V_{GS} @ 10V$	8.1	
I_{DM}	Pulsed Drain Current ①	81	
$P_D @ T_A = 25^\circ C$	Power Dissipation	2.0	W
$P_D @ T_A = 70^\circ C$	Power Dissipation	1.3	
	Linear Derating Factor	0.016	W/°C
T_J	Operating Junction and	-55 to + 175	°C
T_{STG}	Storage Temperature Range		

Thermal Resistance

	Parameter	Typ.	Max.	Units
$R_{\theta JL}$	Junction-to-Drain Lead ⑤	—	42	°C/W
$R_{\theta JA}$	Junction-to-Ambient ④ ⑤	—	62.5	

Notes ① through ⑤ are on page 9

ORDERING INFORMATION:

See detailed ordering and shipping information on the last page of this data sheet.

Static @ $T_J = 25^\circ\text{C}$ (unless otherwise specified)

	Parameter	Min.	Typ.	Max.	Units	Conditions
BV_{DSS}	Drain-to-Source Breakdown Voltage	30	—	—	V	$V_{GS} = 0V, I_D = 250\mu A$
$\Delta BV_{DSS}/\Delta T_J$	Breakdown Voltage Temp. Coefficient	—	0.021	—	$V/^\circ\text{C}$	Reference to $25^\circ\text{C}, I_D = 1\text{mA}$
$R_{DS(on)}$	Static Drain-to-Source On-Resistance	—	12.5	15.5	m Ω	$V_{GS} = 10V, I_D = 9.7A$ ③
		—	18.6	21.6		$V_{GS} = 4.5V, I_D = 8.0A$ ③
$V_{GS(th)}$	Gate Threshold Voltage	1.35	1.80	2.35	V	$V_{DS} = V_{GS}, I_D = 25\mu A$
$\Delta V_{GS(th)}$	Gate Threshold Voltage Coefficient	—	-6.0	—	$\text{mV}/^\circ\text{C}$	
I_{DSS}	Drain-to-Source Leakage Current	—	—	1.0	μA	$V_{DS} = 24V, V_{GS} = 0V$
		—	—	150		$V_{DS} = 24V, V_{GS} = 0V, T_J = 125^\circ\text{C}$
I_{GSS}	Gate-to-Source Forward Leakage	—	—	100	nA	$V_{GS} = 20V$
	Gate-to-Source Reverse Leakage	—	—	-100		$V_{GS} = -20V$
gfs	Forward Transconductance	23	—	—	S	$V_{DS} = 15V, I_D = 8.0A$
Q_g	Total Gate Charge	—	6.0	9.0	nC	$V_{DS} = 15V$ $V_{GS} = 4.5V$ $I_D = 8.0A$ See Figs. 17a & 17b
Q_{gs1}	Pre-Vth Gate-to-Source Charge	—	1.5	—		
Q_{gs2}	Post-Vth Gate-to-Source Charge	—	0.9	—		
Q_{gd}	Gate-to-Drain Charge	—	2.2	—		
Q_{godr}	Gate Charge Overdrive	—	1.4	—		
Q_{sw}	Switch Charge ($Q_{gs2} + Q_{gd}$)	—	2.9	—		
Q_{oss}	Output Charge	—	3.8	—	nC	$V_{DS} = 16V, V_{GS} = 0V$
R_g	Gate Resistance	—	2.2	3.6	Ω	
$t_{d(on)}$	Turn-On Delay Time	—	8.3	—	ns	$V_{DD} = 15V, V_{GS} = 4.5V$ $I_D = 8.0A$ $R_G = 1.8\Omega$ See Fig. 15a & 15b
t_r	Rise Time	—	9.9	—		
$t_{d(off)}$	Turn-Off Delay Time	—	8.5	—		
t_f	Fall Time	—	4.2	—		
C_{iss}	Input Capacitance	—	760	—	pF	$V_{GS} = 0V$ $V_{DS} = 15V$ $f = 1.0\text{MHz}$
C_{oss}	Output Capacitance	—	172	—		
C_{rss}	Reverse Transfer Capacitance	—	87	—		

Avalanche Characteristics

	Parameter	Typ.	Max.	Units
E_{AS}	Single Pulse Avalanche Energy ②	—	46	mJ
I_{AR}	Avalanche Current ①	—	8.0	A

Diode Characteristics

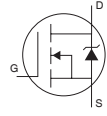
	Parameter	Min.	Typ.	Max.	Units	Conditions
I_S	Continuous Source Current (Body Diode)	—	—	3.1	A	MOSFET symbol showing the integral reverse p-n junction diode. 
I_{SM}	Pulsed Source Current (Body Diode) ①	—	—	82	A	
V_{SD}	Diode Forward Voltage	—	—	1.0	V	$T_J = 25^\circ\text{C}, I_S = 8.0A, V_{GS} = 0V$ ③
t_{rr}	Reverse Recovery Time	—	20	30	ns	$T_J = 25^\circ\text{C}, I_F = 8.0A, V_{DD} = 15V$
Q_{rr}	Reverse Recovery Charge	—	10	15	nC	$di/dt = 100A/\mu s$ ③
t_{on}	Forward Turn-On Time	Intrinsic turn-on time is negligible (turn-on is dominated by LS+LD)				

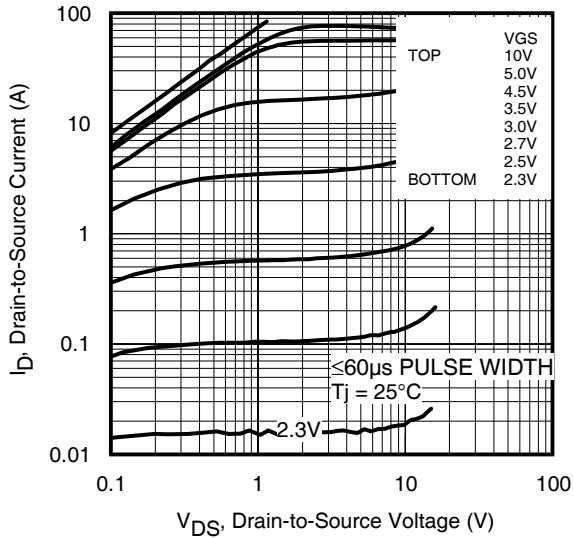

Fig 1. Typical Output Characteristics

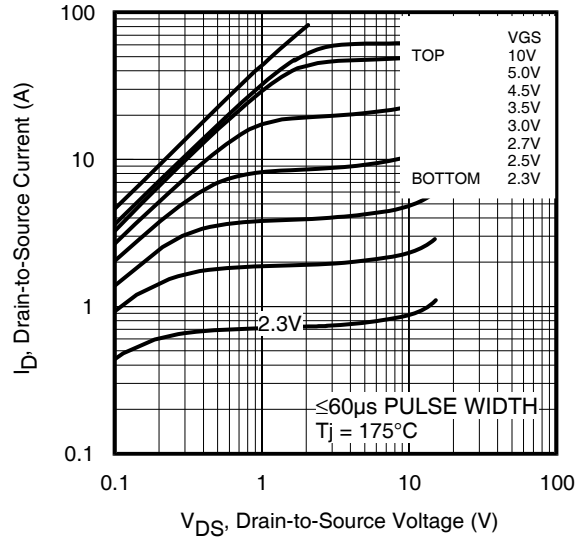

Fig 2. Typical Output Characteristics

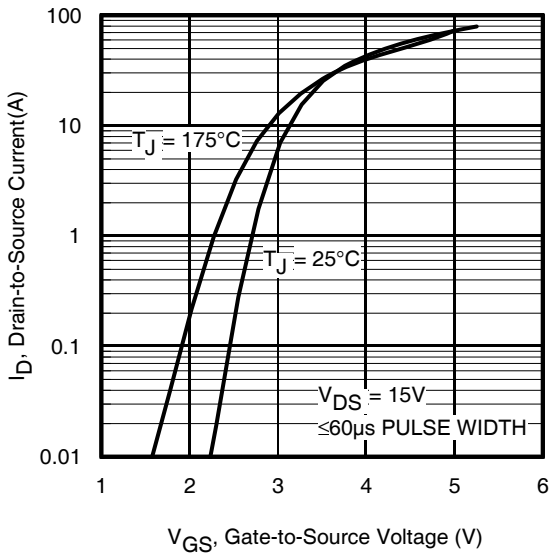

Fig 3. Typical Transfer Characteristics

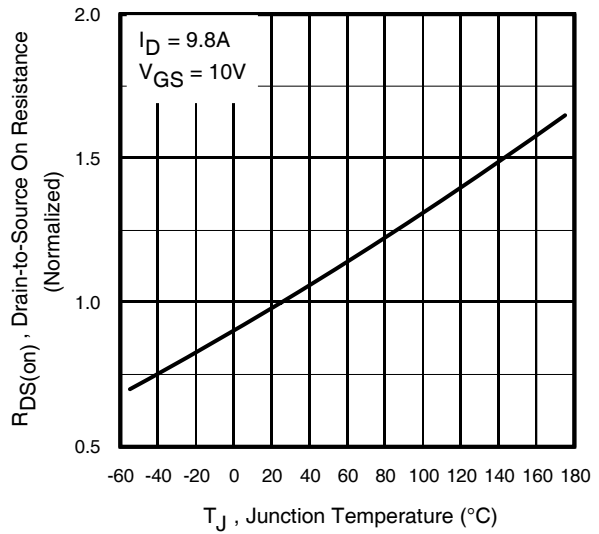

Fig 4. Normalized On-Resistance vs. Temperature

IRF8313PbF

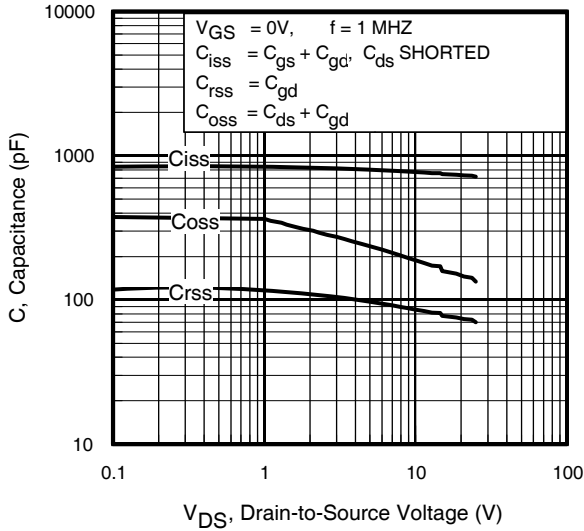

Fig 5. Typical Capacitance vs. Drain-to-Source Voltage

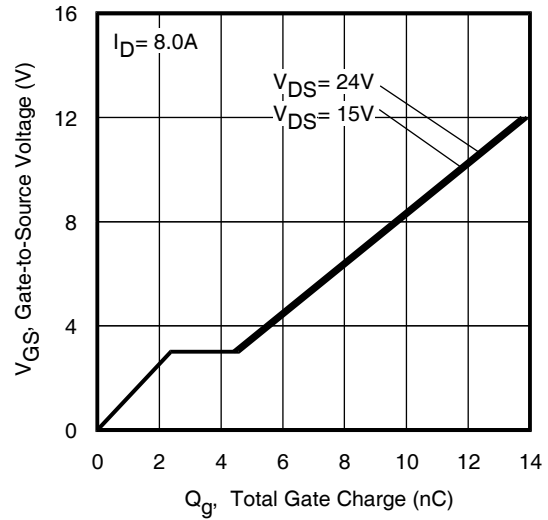

Fig 6. Typical Gate Charge vs. Gate-to-Source Voltage

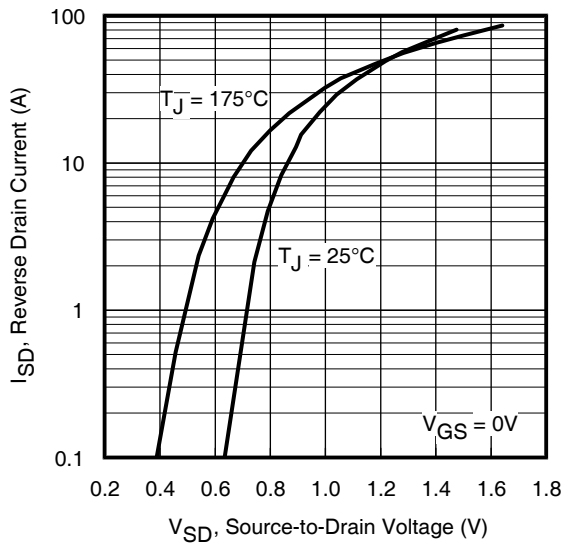

Fig 7. Typical Source-Drain Diode Forward Voltage

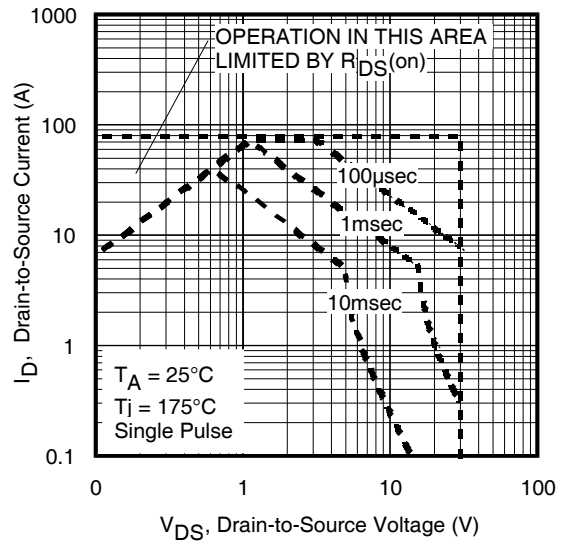

Fig 8. Maximum Safe Operating Area

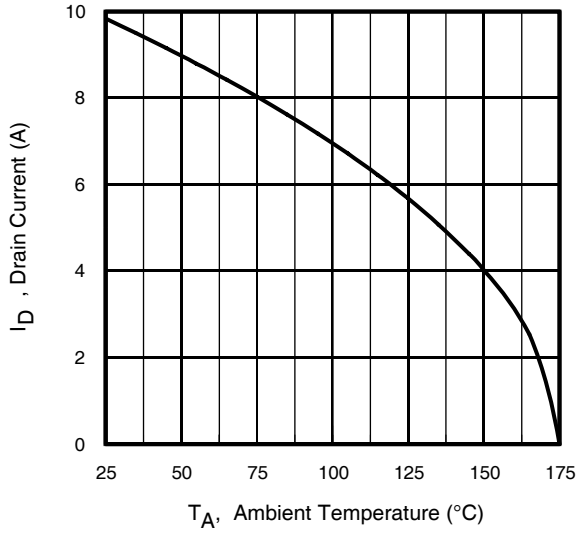

Fig 9. Maximum Drain Current vs. Ambient Temperature

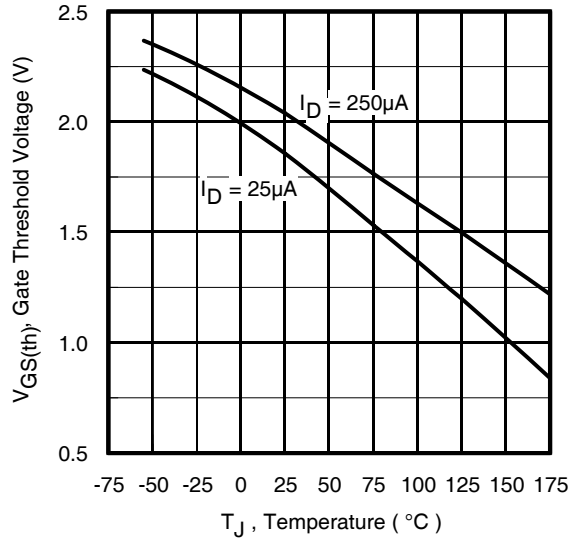

Fig 10. Threshold Voltage vs. Temperature

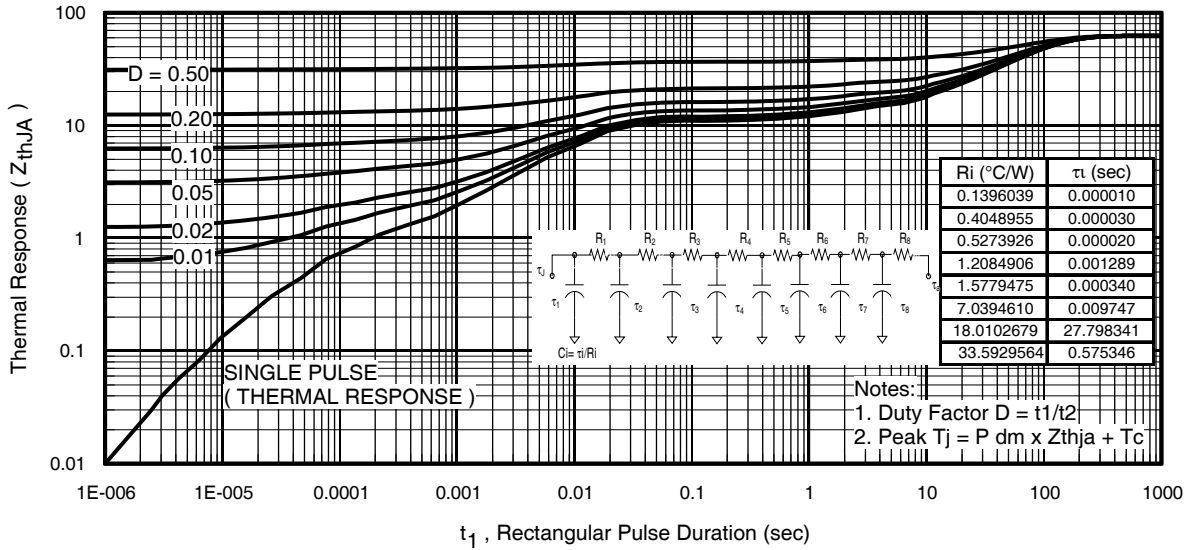

Fig 11. Maximum Effective Transient Thermal Impedance, Junction-to-Ambient

IRF8313PbF

International
IR Rectifier

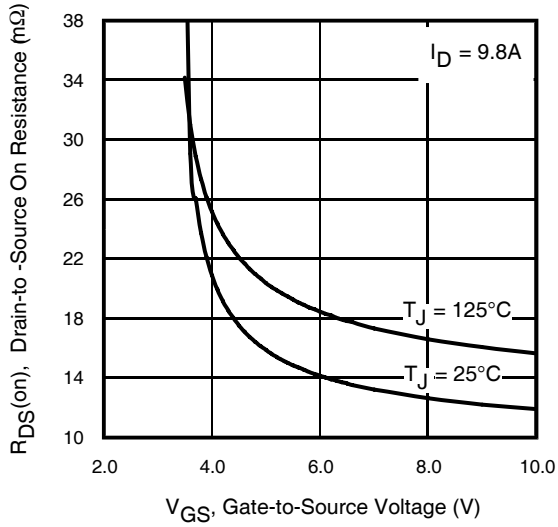

Fig 12. On-Resistance vs. Gate Voltage

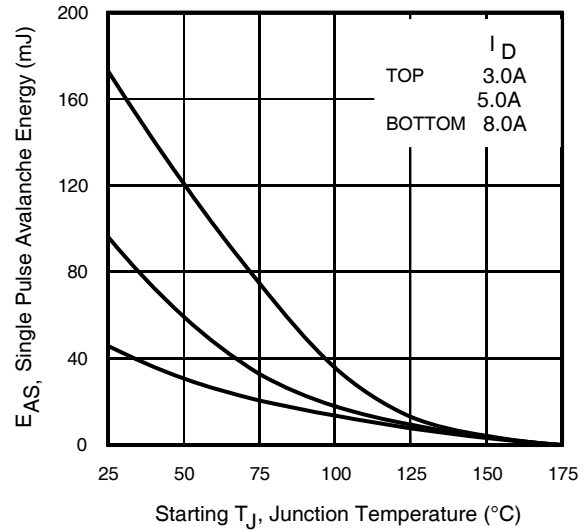

Fig 13. Maximum Avalanche Energy vs. Drain Current

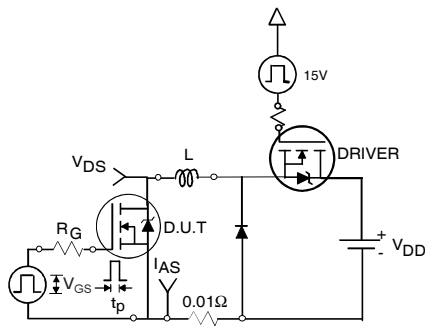

Fig 14a. Unclamped Inductive Test Circuit

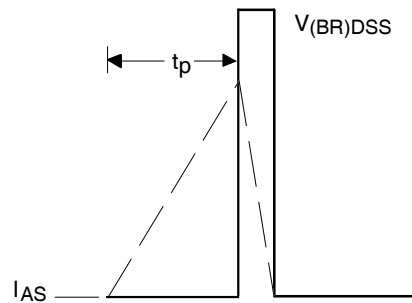

Fig 14b. Unclamped Inductive Waveforms

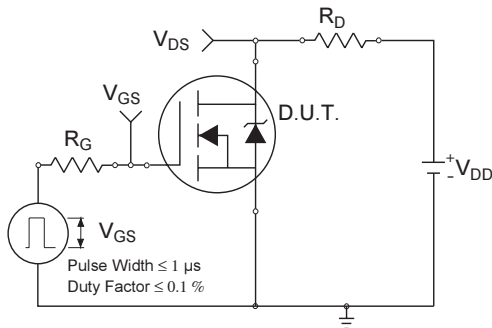

Fig 15a. Switching Time Test Circuit

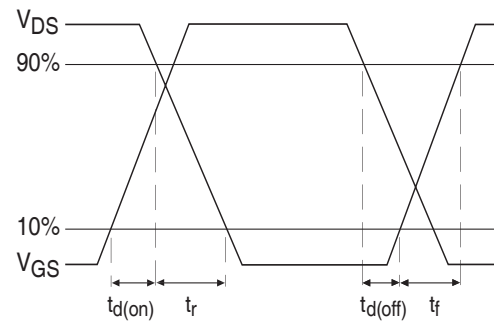
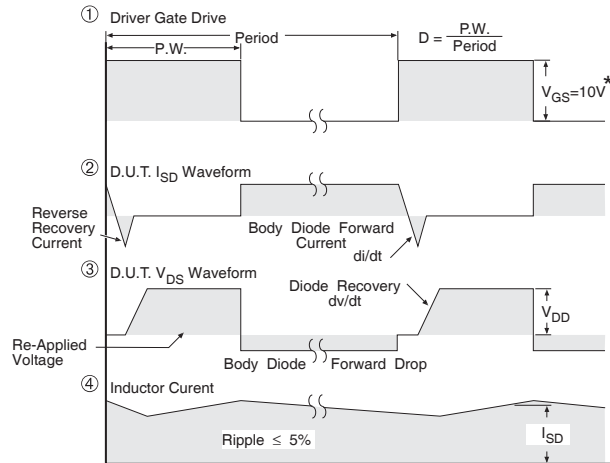
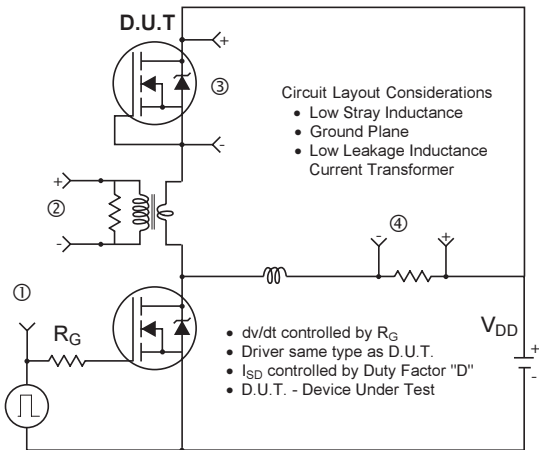

Fig 15b. Switching Time Waveforms
www.irf.com



* $V_{GS} = 5V$ for Logic Level Devices

Fig 16. Peak Diode Recovery dv/dt Test Circuit for N-Channel HEXFET® Power MOSFETs

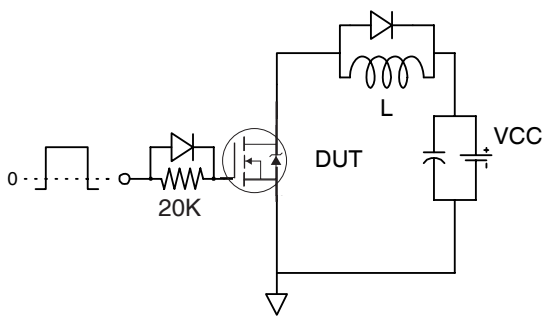

Fig 17a. Gate Charge Test Circuit

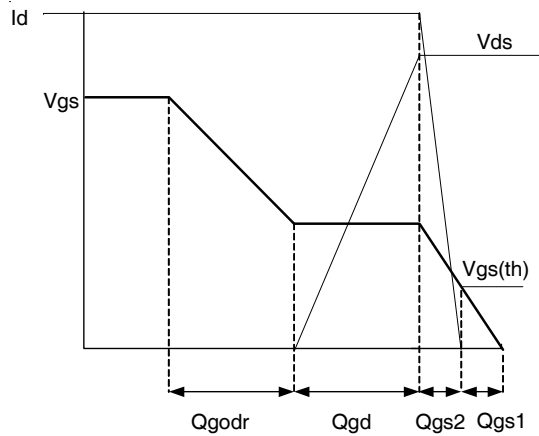

Fig 17b. Gate Charge Waveform

IRF8313PbF

SO-8 Package Outline

International
IR Rectifier

Dimensions are shown in millimeters (inches)

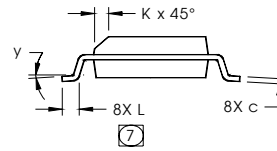
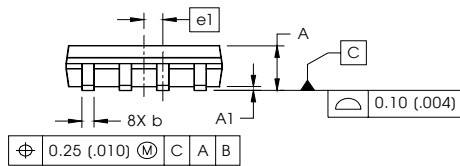
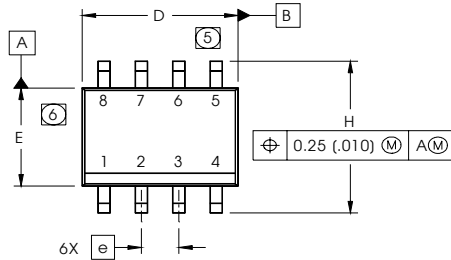

DIM	INCHES		MILLIMETERS	
	MIN	MAX	MIN	MAX
A	.0532	.0688	1.35	1.75
A1	.0040	.0098	0.10	0.25
b	.013	.020	0.33	0.51
c	.0075	.0098	0.19	0.25
D	.189	.1968	4.80	5.00
E	.1497	.1574	3.80	4.00
e	.050 BASIC		1.27 BASIC	
e1	.025 BASIC		0.635 BASIC	
H	.2284	.2440	5.80	6.20
K	.0099	.0196	0.25	0.50
L	.016	.050	0.40	1.27
y	0°	8°	0°	8°

FOOTPRINT

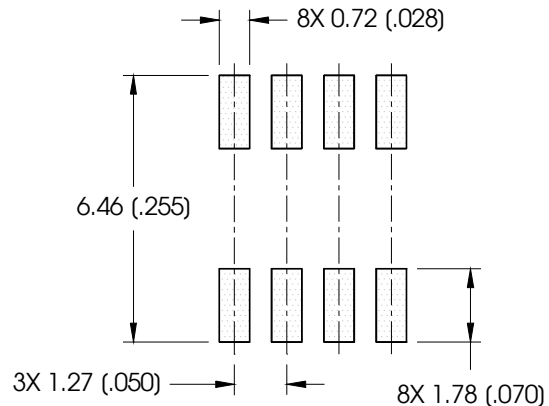

NOTES:

1. DIMENSIONING & TOLERANCING PER ASME Y14.5M-1994.
2. CONTROLLING DIMENSION: MILLIMETER
3. DIMENSIONS ARE SHOWN IN MILLIMETERS (INCHES).
4. OUTLINE CONFORMS TO JEDEC OUTLINE MS-012AA.
- ⑤ DIMENSION DOES NOT INCLUDE MOLD PROTRUSIONS. MOLD PROTRUSIONS NOT TO EXCEED 0.15 (.006).
- ⑥ DIMENSION DOES NOT INCLUDE MOLD PROTRUSIONS. MOLD PROTRUSIONS NOT TO EXCEED 0.25 (.010).
- ⑦ DIMENSION IS THE LENGTH OF LEAD FOR SOLDERING TO A SUBSTRATE.

SO-8 Part Marking Information

EXAMPLE: THIS IS AN IRF7101 (MOSFET)

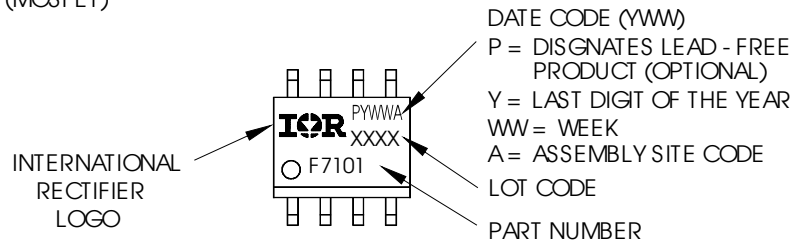

Note: For the most current drawing please refer to IR website at <http://www.irf.com/package/>

SO-8 Tape and Reel

Dimensions are shown in millimeters (inches)

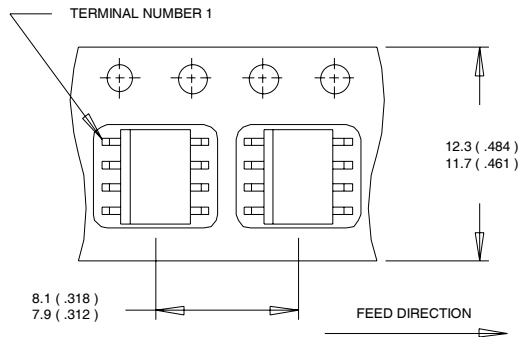

- NOTES:
1. CONTROLLING DIMENSION : MILLIMETER.
 2. ALL DIMENSIONS ARE SHOWN IN MILLIMETERS(INCHES).
 3. OUTLINE CONFORMS TO EIA-481 & EIA-541.

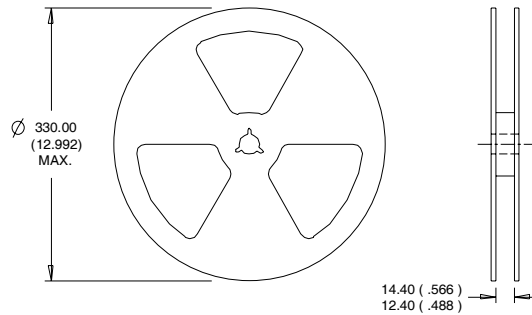

- NOTES:
1. CONTROLLING DIMENSION : MILLIMETER.
 2. OUTLINE CONFORMS TO EIA-481 & EIA-541.

Notes:

- ① Repetitive rating; pulse width limited by max. junction temperature.
- ② Starting $T_J = 25^\circ\text{C}$, $L = 1.43\text{mH}$, $R_G = 25\Omega$, $I_{AS} = 8.0\text{A}$.
- ③ Pulse width $\leq 400\mu\text{s}$; duty cycle $\leq 2\%$.
- ④ When mounted on 1 inch square copper board.
- ⑤ R_θ is measured at T_J of approximately 90°C .

Note: For the most current drawing please refer to IR website at <http://www.irf.com/package/>

IRF8313PbF

International
IR Rectifier

Orderable Part number	Package Type	Standard Pack		Note
		Form	Quantity	
IRF8313PbF	SO-8	Tube/Bulk	95	
IRF8313TRPbF	SO-8	Tape and Reel	4000	

Qualification Information[†]

Qualification Level	Consumer ^{††} (per JEDEC JESD47F ^{†††} guidelines)		
Moisture Sensitivity Level	SO-8	MSL1 (per JEDEC J-STD-020D ^{†††})	
RoHS Compliant	Yes		

† Qualification standards can be found at International Rectifier's web site: <http://www.irf.com/>

†† Higher qualification ratings may be available should the user have such requirements.

Please contact your International Rectifier sales representative for further information:

<http://www.irf.com/whoto-call/salesrep/>

††† Applicable version of JEDEC standard at the time of product release.

Data and specifications subject to change without notice.

International
IR Rectifier

IR WORLD HEADQUARTERS: 233 Kansas St., El Segundo, California 90245, USA Tel: (310) 252-7105
TAC Fax: (310) 252-7903

Visit us at www.irf.com for sales contact information.11/08

www.irf.com

IMPORTANT NOTICE

The information given in this document shall in no event be regarded as a guarantee of conditions or characteristics ("Beschaffheitsgarantie").

With respect to any examples, hints or any typical values stated herein and/or any information regarding the application of the product, Infineon Technologies hereby disclaims any and all warranties and liabilities of any kind, including without limitation warranties of non-infringement of intellectual property rights of any third party.

In addition, any information given in this document is subject to customer's compliance with its obligations stated in this document and any applicable legal requirements, norms and standards concerning customer's products and any use of the product of Infineon Technologies in customer's applications.

The data contained in this document is exclusively intended for technically trained staff. It is the responsibility of customer's technical departments to evaluate the suitability of the product for the intended application and the completeness of the product information given in this document with respect to such application.

For further information on the product, technology, delivery terms and conditions and prices please contact your nearest Infineon Technologies office (www.infineon.com).

WARNINGS

Due to technical requirements products may contain dangerous substances. For information on the types in question please contact your nearest Infineon Technologies office.

Except as otherwise explicitly approved by Infineon Technologies in a written document signed by authorized representatives of Infineon Technologies, Infineon Technologies' products may not be used in any applications where a failure of the product or any consequences of the use thereof can reasonably be expected to result in personal injury.