

## Cool MOS™ Power Transistor

### Feature

- New revolutionary high voltage technology
- Ultra low gate charge
- Periodic avalanche rated
- Extreme  $dv/dt$  rated
- High peak current capability
- Improved transconductance
- PG-TO-220-3-31;-3-111: Fully isolated package (2500 VAC; 1 minute)
- Pb-free lead plating; RoHS compliant
- Qualified according to JEDEC<sup>0)</sup> for target applications

$V_{DS} @ T_{jmax}$	650	V
$R_{DS(on)}$	0.6	$\Omega$
$I_D$	7.3	A

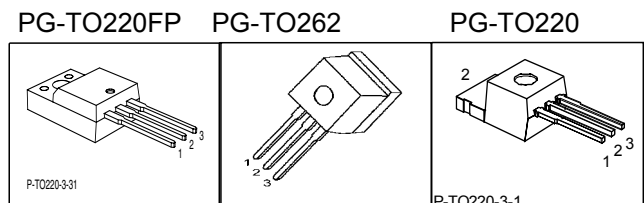

Type	Package	Ordering Code	Marking
SPP07N60C3	PG-TO220-3	Q67040-S4400	07N60C3
SPI07N60C3	PG-TO262	Q67040-S4424	07N60C3
SPA07N60C3	PG-TO220FP	SP000216303	07N60C3

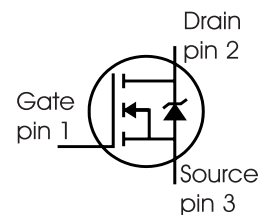

### Maximum Ratings

Parameter	Symbol	Value		Unit
		SPP_I	SPA	
Continuous drain current $T_C = 25\text{ }^\circ\text{C}$ $T_C = 100\text{ }^\circ\text{C}$	$I_D$	7.3 4.6	7.3 <sup>1)</sup> 4.6 <sup>1)</sup>	A
Pulsed drain current, $t_p$ limited by $T_{jmax}$	$I_{D\text{ puls}}$	21.9	21.9	A
Avalanche energy, single pulse $I_D=5.5\text{A}, V_{DD}=50\text{V}$	$E_{AS}$	230	230	mJ
Avalanche energy, repetitive $t_{AR}$ limited by $T_{jmax}$ <sup>2)</sup> $I_D=7.3\text{A}, V_{DD}=50\text{V}$	$E_{AR}$	0.5	0.5	
Avalanche current, repetitive $t_{AR}$ limited by $T_{jmax}$	$I_{AR}$	7.3	7.3	A
Gate source voltage static	$V_{GS}$	$\pm 20$	$\pm 20$	V
Gate source voltage AC ( $f > 1\text{Hz}$ )	$V_{GS}$	$\pm 30$	$\pm 30$	
Power dissipation, $T_C = 25\text{ }^\circ\text{C}$	$P_{tot}$	83	32	W
Operating and storage temperature	$T_j, T_{stg}$	-55...+150		$^\circ\text{C}$
Reverse diode $dv/dt$ <sup>6)</sup>	$dv/dt$	15		V/ns

### Maximum Ratings

Parameter	Symbol	Value	Unit
Drain Source voltage slope $V_{DS} = 480\text{ V}$ , $I_D = 7.3\text{ A}$ , $T_j = 125\text{ °C}$	$dv/dt$	50	V/ns

### Thermal Characteristics

Parameter	Symbol	Values			Unit
		min.	typ.	max.	
Thermal resistance, junction - case	$R_{thJC}$	-	-	1.5	K/W
Thermal resistance, junction - case, FullPAK	$R_{thJC\text{ FP}}$	-	-	3.9	
Thermal resistance, junction - ambient, leaded	$R_{thJA}$	-	-	62	
Thermal resistance, junction - ambient, FullPAK	$R_{thJA\text{ FP}}$	-	-	80	
SMD version, device on PCB: @ min. footprint @ 6 cm <sup>2</sup> cooling area <sup>3)</sup>	$R_{thJA}$	-	-	62	
Soldering temperature, wavesoldering 1.6 mm (0.063 in.) from case for 10s	$T_{sold}$	-	-	260	°C

### Electrical Characteristics, at $T_j=25\text{ °C}$ unless otherwise specified

Parameter	Symbol	Conditions	Values			Unit
			min.	typ.	max.	
Drain-source breakdown voltage	$V_{(BR)DSS}$	$V_{GS}=0\text{V}$ , $I_D=0.25\text{mA}$	600	-	-	V
Drain-Source avalanche breakdown voltage	$V_{(BR)DS}$	$V_{GS}=0\text{V}$ , $I_D=7.3\text{A}$	-	700	-	
Gate threshold voltage	$V_{GS(th)}$	$I_D=350\mu\text{A}$ , $V_{GS}=V_{DS}$	2.1	3	3.9	
Zero gate voltage drain current	$I_{DSS}$	$V_{DS}=600\text{V}$ , $V_{GS}=0\text{V}$ , $T_j=25\text{ °C}$ $T_j=150\text{ °C}$	-	0.5	1	μA
Gate-source leakage current	$I_{GSS}$	$V_{GS}=30\text{V}$ , $V_{DS}=0\text{V}$	-	-	100	
Drain-source on-state resistance	$R_{DS(on)}$	$V_{GS}=10\text{V}$ , $I_D=4.6\text{A}$ $T_j=25\text{ °C}$ $T_j=150\text{ °C}$	-	0.54	0.6	Ω
Gate input resistance	$R_G$	$f=1\text{MHz}$ , open drain	-	0.8	-	

**Electrical Characteristics**, at  $T_j = 25\text{ }^\circ\text{C}$ , unless otherwise specified

Parameter	Symbol	Conditions	Values			Unit
			min.	typ.	max.	
<b>Characteristics</b>						
Transconductance	$g_{fs}$	$V_{DS} \geq 2 \cdot I_D \cdot R_{DS(on)max}$ , $I_D = 4.6\text{A}$	-	6	-	S
Input capacitance	$C_{iss}$	$V_{GS} = 0\text{V}$ , $V_{DS} = 25\text{V}$ , $f = 1\text{MHz}$	-	790	-	pF
Output capacitance	$C_{oss}$		-	260	-	
Reverse transfer capacitance	$C_{rss}$		-	16	-	
Effective output capacitance, <sup>4)</sup> energy related	$C_{o(er)}$	$V_{GS} = 0\text{V}$ , $V_{DS} = 0\text{V to } 480\text{V}$	-	30	-	
Effective output capacitance, <sup>5)</sup> time related	$C_{o(tr)}$		-	55	-	
Turn-on delay time	$t_{d(on)}$	$V_{DD} = 380\text{V}$ , $V_{GS} = 0/13\text{V}$ , $I_D = 7.3\text{A}$ , $R_G = 12\Omega$ , $T_j = 125\text{ }^\circ\text{C}$	-	6	-	ns
Rise time	$t_r$		-	3.5	-	
Turn-off delay time	$t_{d(off)}$		-	60	100	
Fall time	$t_f$		-	7	15	

**Gate Charge Characteristics**

Gate to source charge	$Q_{gs}$	$V_{DD} = 480\text{V}$ , $I_D = 7.3\text{A}$	-	3	-	nC
Gate to drain charge	$Q_{gd}$		-	9.2	-	
Gate charge total	$Q_g$	$V_{DD} = 480\text{V}$ , $I_D = 7.3\text{A}$ , $V_{GS} = 0\text{ to } 10\text{V}$	-	21	27	
Gate plateau voltage	$V_{(plateau)}$	$V_{DD} = 480\text{V}$ , $I_D = 7.3\text{A}$	-	5.5	-	V

<sup>0</sup>J-STD20 and JESD22

<sup>1</sup>Limited only by maximum temperature

<sup>2</sup>Repetitive avalanche causes additional power losses that can be calculated as  $P_{AV} = E_{AR} \cdot f$ .

<sup>3</sup>Device on 40mm\*40mm\*1.5mm epoxy PCB FR4 with 6cm<sup>2</sup> (one layer, 70 μm thick) copper area for drain connection. PCB is vertical without blown air.

<sup>4</sup> $C_{o(er)}$  is a fixed capacitance that gives the same stored energy as  $C_{oss}$  while  $V_{DS}$  is rising from 0 to 80%  $V_{DSS}$ .

<sup>5</sup> $C_{o(tr)}$  is a fixed capacitance that gives the same charging time as  $C_{oss}$  while  $V_{DS}$  is rising from 0 to 80%  $V_{DSS}$ .

<sup>6</sup> $I_{SD} \leq I_D$ ,  $di/dt \leq 400\text{A}/\mu\text{s}$ ,  $V_{DClintk} = 400\text{V}$ ,  $V_{peak} < V_{BR, DSS}$ ,  $T_j < T_{j,max}$ .

Identical low-side and high-side switch.

### Electrical Characteristics

Parameter	Symbol	Conditions	Values			Unit
			min.	typ.	max.	
Inverse diode continuous forward current	$I_S$	$T_C=25^\circ\text{C}$	-	-	7.3	A
Inverse diode direct current, pulsed	$I_{SM}$		-	-	21.9	
Inverse diode forward voltage	$V_{SD}$	$V_{GS}=0\text{V}, I_F=I_S$	-	1	1.2	V
Reverse recovery time	$t_{rr}$	$V_R=480\text{V}, I_F=I_S,$	-	400	600	ns
Reverse recovery charge	$Q_{rr}$	$di_F/dt=100\text{A}/\mu\text{s}$	-	4	-	$\mu\text{C}$
Peak reverse recovery current	$I_{rrm}$		-	28	-	A
Peak rate of fall of reverse recovery current	$di_{rr}/dt$	$T_j=25^\circ\text{C}$	-	800	-	$\text{A}/\mu\text{s}$

### Typical Transient Thermal Characteristics

Symbol	Value		Unit	Symbol	Value		Unit
	SPP_I	SPA			SPP_I	SPA	
$R_{th1}$	0.024	0.024	K/W	$C_{th1}$	0.00012	0.00012	Ws/K
$R_{th2}$	0.046	0.046		$C_{th2}$	0.0004578	0.0004578	
$R_{th3}$	0.085	0.085		$C_{th3}$	0.000645	0.000645	
$R_{th4}$	0.308	0.195		$C_{th4}$	0.001867	0.001867	
$R_{th5}$	0.317	0.45		$C_{th5}$	0.004795	0.007558	
$R_{th6}$	0.112	2.511		$C_{th6}$	0.045	0.412	

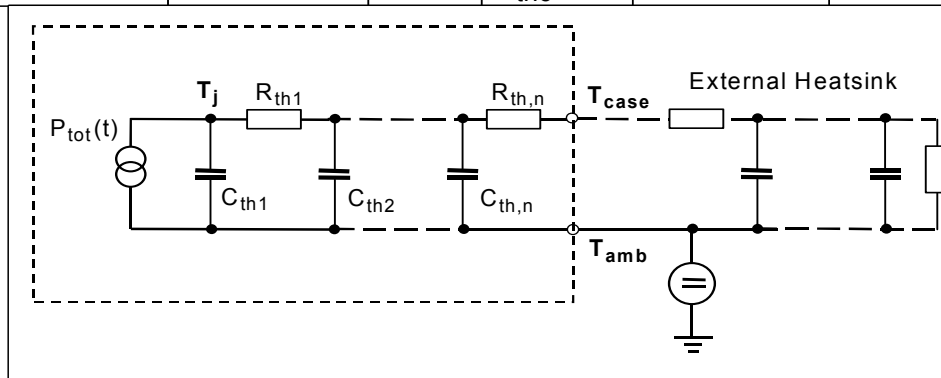

### 1 Power dissipation

$$P_{tot} = f(T_C)$$

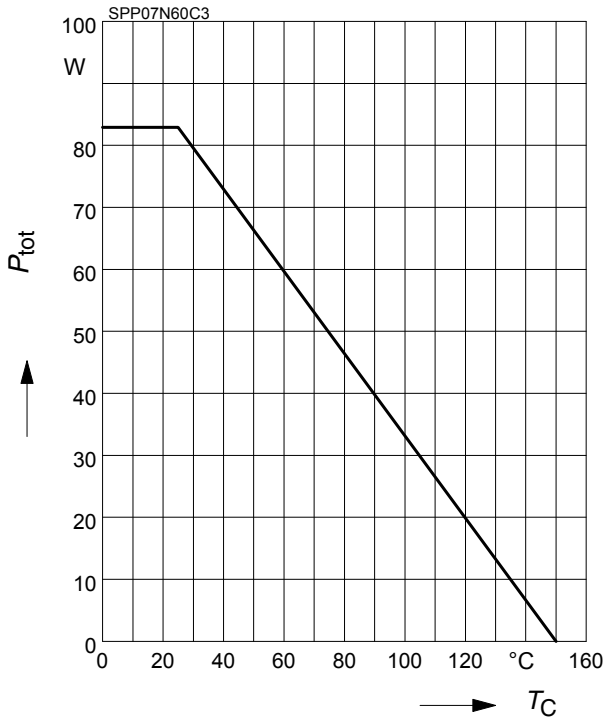

### 2 Power dissipation FullPAK

$$P_{tot} = f(T_C)$$

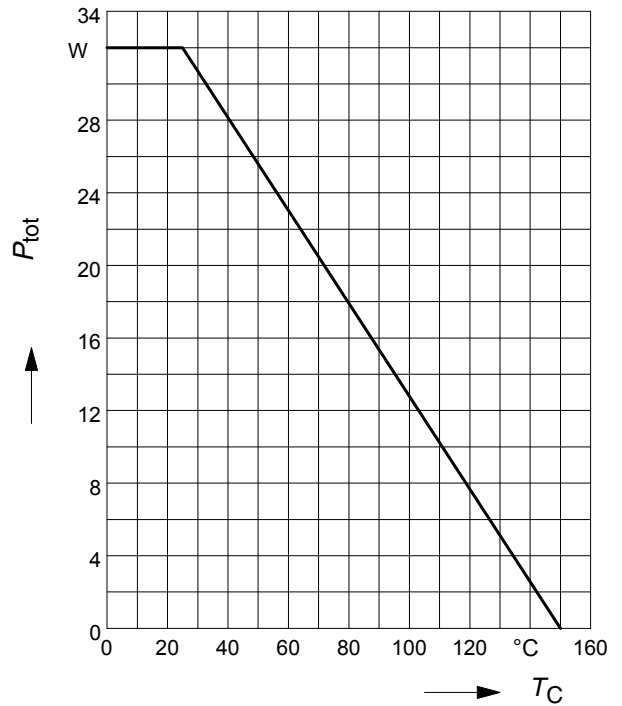

### 3 Safe operating area

$$I_D = f(V_{DS})$$

parameter :  $D = 0$  ,  $T_C = 25^\circ\text{C}$

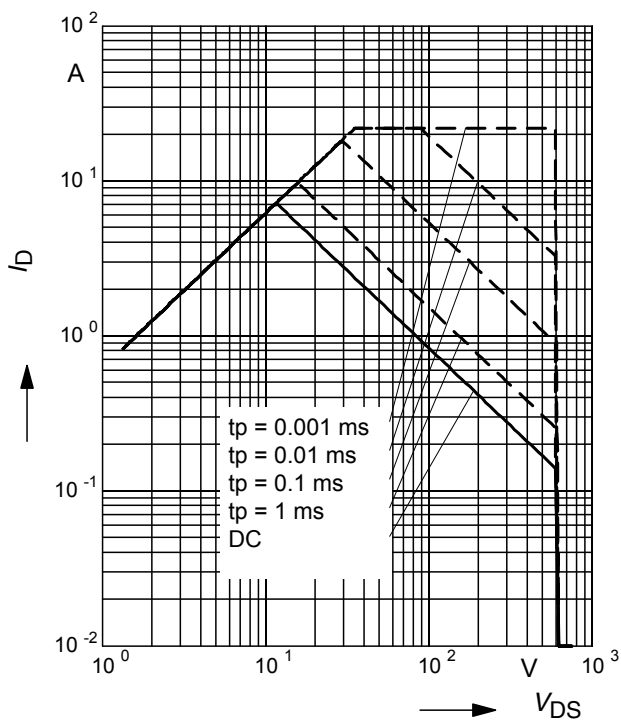

### 4 Safe operating area FullPAK

$$I_D = f(V_{DS})$$

parameter:  $D = 0$  ,  $T_C = 25^\circ\text{C}$

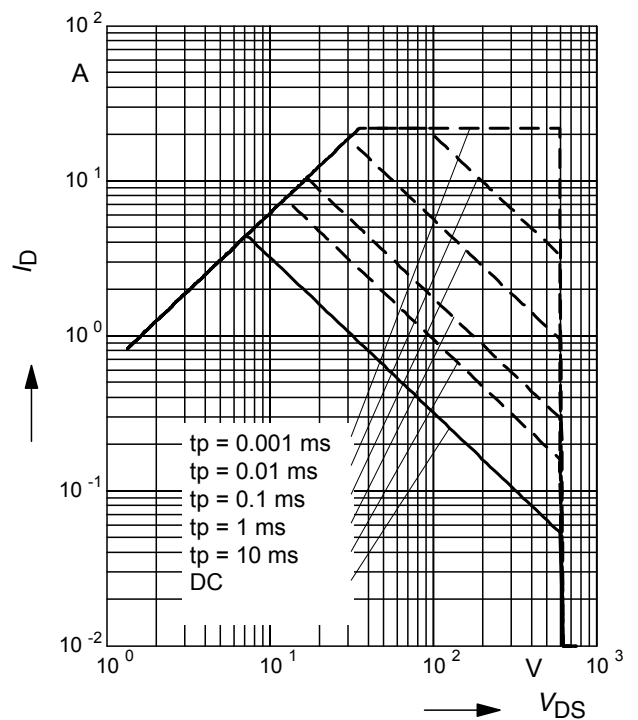

### 5 Transient thermal impedance

$$Z_{thJC} = f(t_p)$$

parameter:  $D = t_p/T$

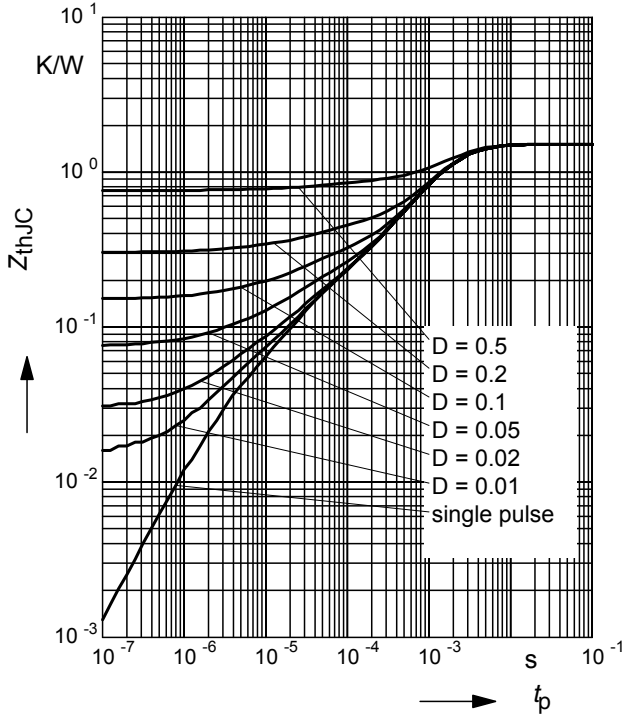

### 6 Transient thermal impedance FullPAK

$$Z_{thJC} = f(t_p)$$

parameter:  $D = t_p/t$

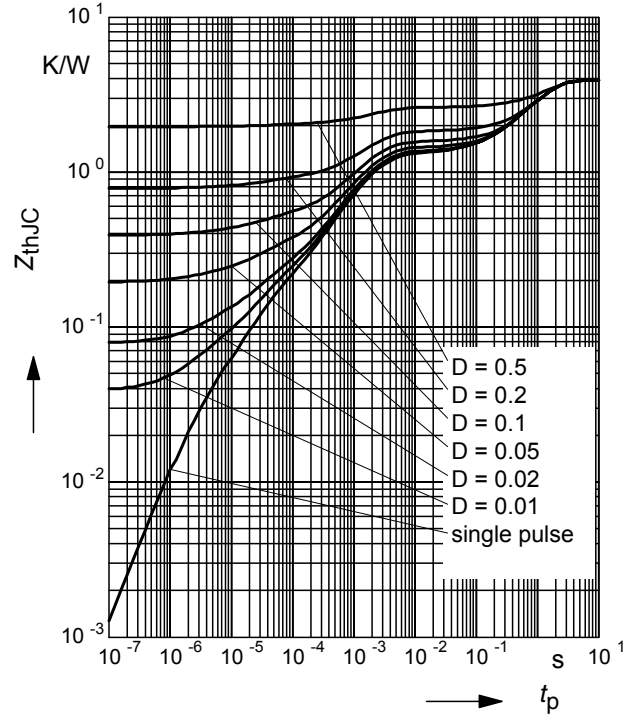

### 7 Typ. output characteristic

$$I_D = f(V_{DS}); T_j = 25^\circ\text{C}$$

parameter:  $t_p = 10 \mu\text{s}, V_{GS}$

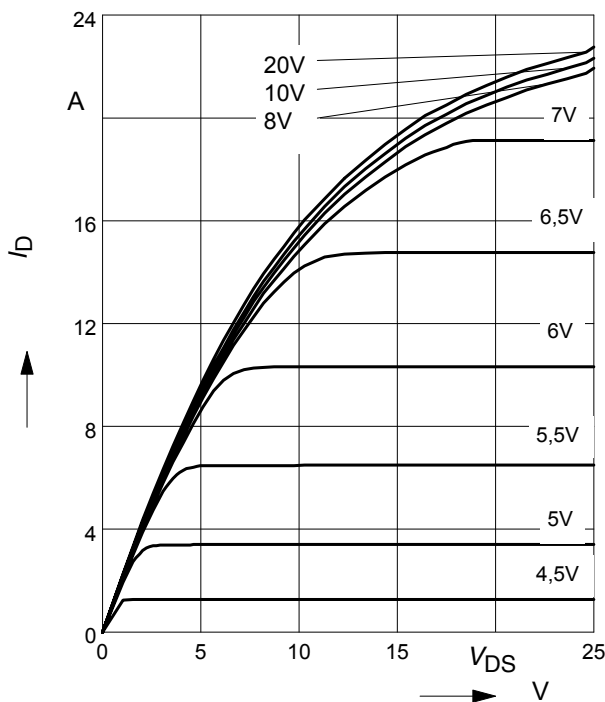

### 8 Typ. output characteristic

$$I_D = f(V_{DS}); T_j = 150^\circ\text{C}$$

parameter:  $t_p = 10 \mu\text{s}, V_{GS}$

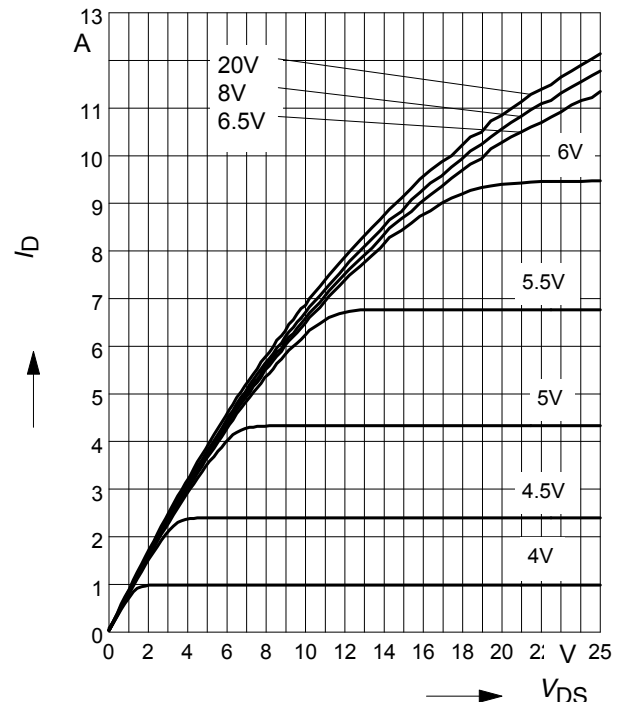

**9 Typ. drain-source on resistance**

$$R_{DS(on)} = f(I_D)$$

parameter:  $T_j = 150^\circ\text{C}$ ,  $V_{GS}$

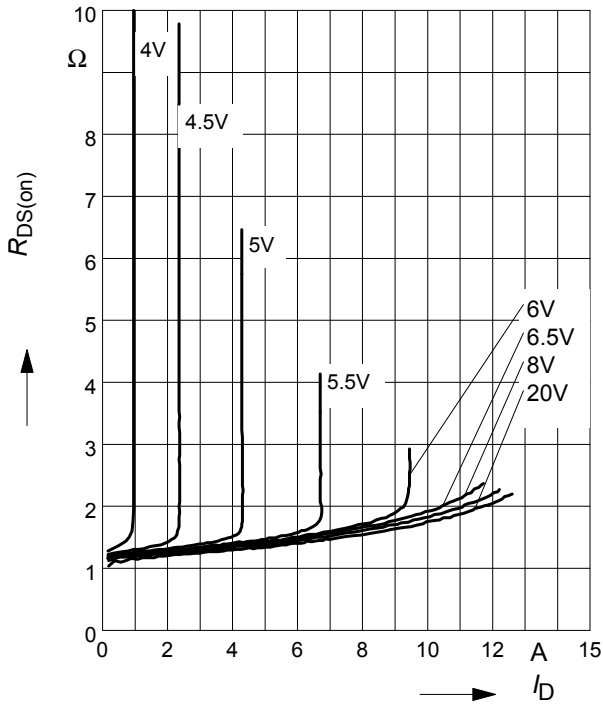

**10 Drain-source on-state resistance**

$$R_{DS(on)} = f(T_j)$$

parameter:  $I_D = 4.6\text{ A}$ ,  $V_{GS} = 10\text{ V}$

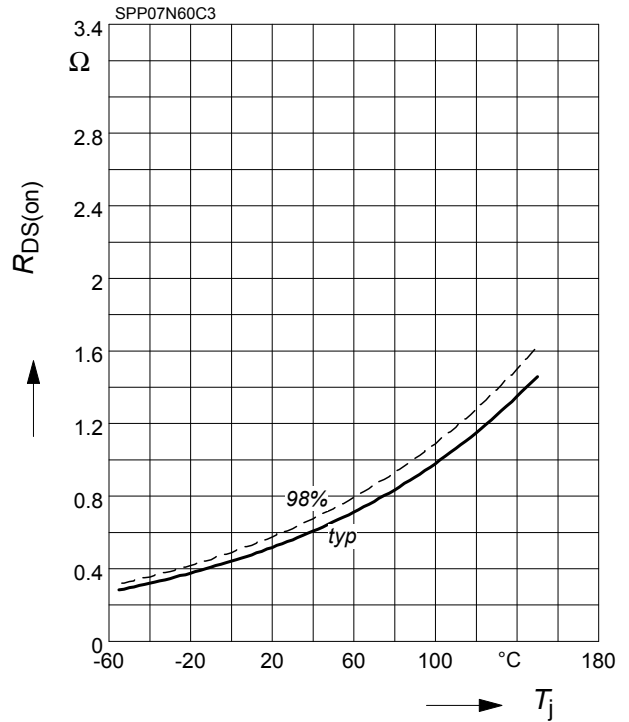

**11 Typ. transfer characteristics**

$$I_D = f(V_{GS}); V_{DS} \geq 2 \times I_D \times R_{DS(on)max}$$

parameter:  $t_p = 10\ \mu\text{s}$

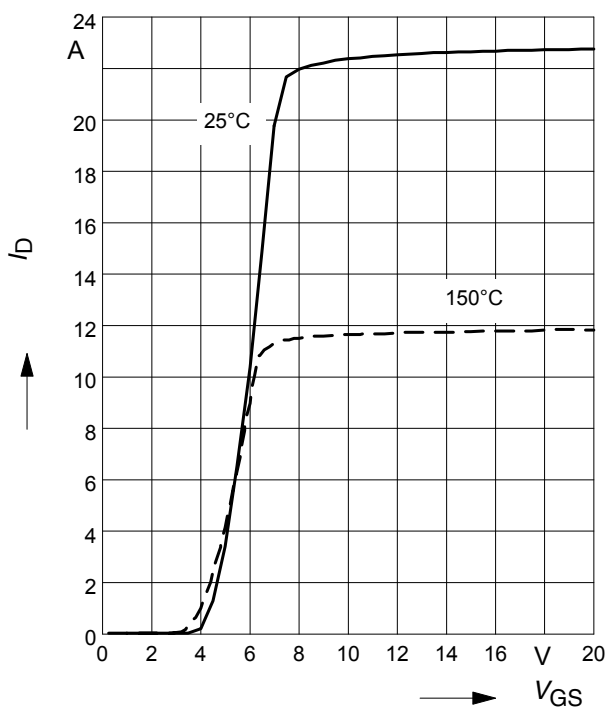

**12 Typ. gate charge**

$$V_{GS} = f(Q_{Gate})$$

parameter:  $I_D = 7.3\text{ A}$  pulsed

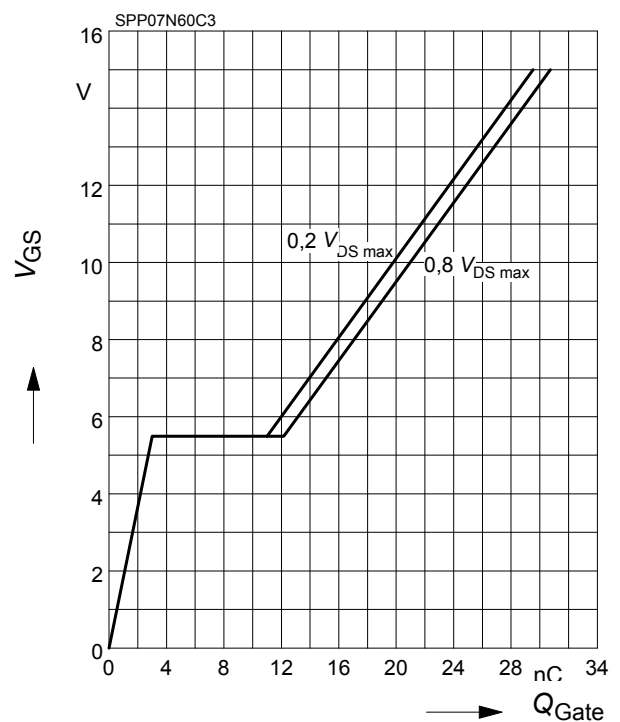

**13 Forward characteristics of body diode**

$I_F = f(V_{SD})$

parameter:  $T_j$ ,  $t_p = 10 \mu s$

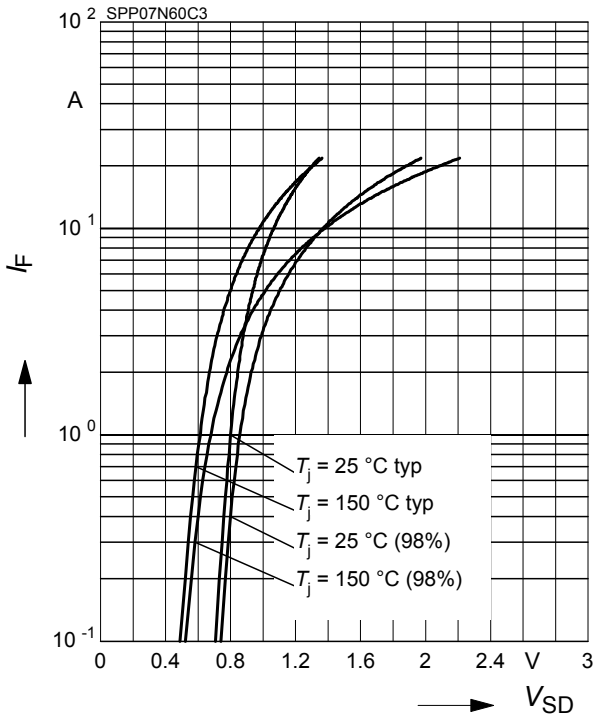

**14 Typ. switching time**

$t = f(I_D)$ , inductive load,  $T_j = 125^\circ C$

par.:  $V_{DS} = 380V$ ,  $V_{GS} = 0/+13V$ ,  $R_G = 12\Omega$

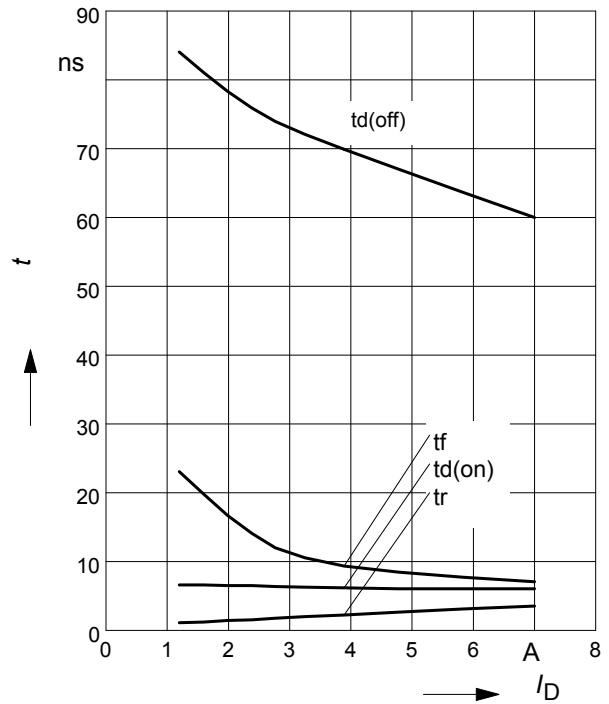

**15 Typ. switching time**

$t = f(R_G)$ , inductive load,  $T_j = 125^\circ C$

par.:  $V_{DS} = 380V$ ,  $V_{GS} = 0/+13V$ ,  $I_D = 7.3 A$

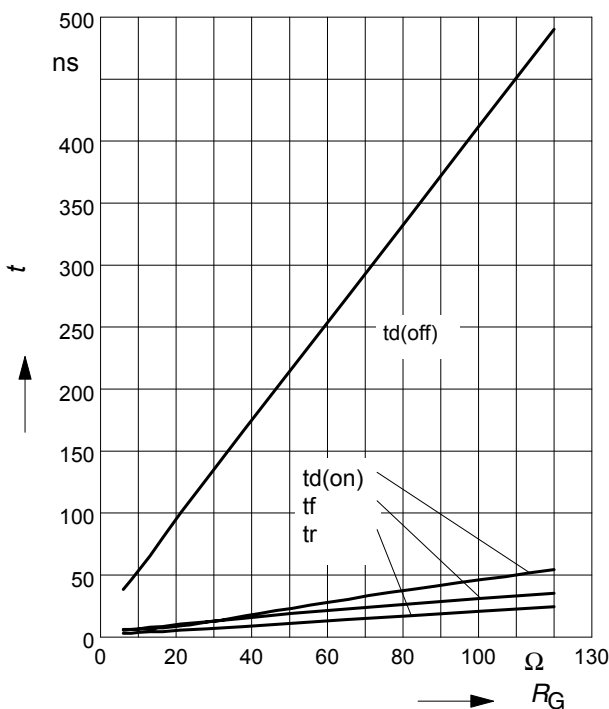

**16 Typ. drain current slope**

$di/dt = f(R_G)$ , inductive load,  $T_j = 125^\circ C$

par.:  $V_{DS} = 380V$ ,  $V_{GS} = 0/+13V$ ,  $I_D = 7.3A$

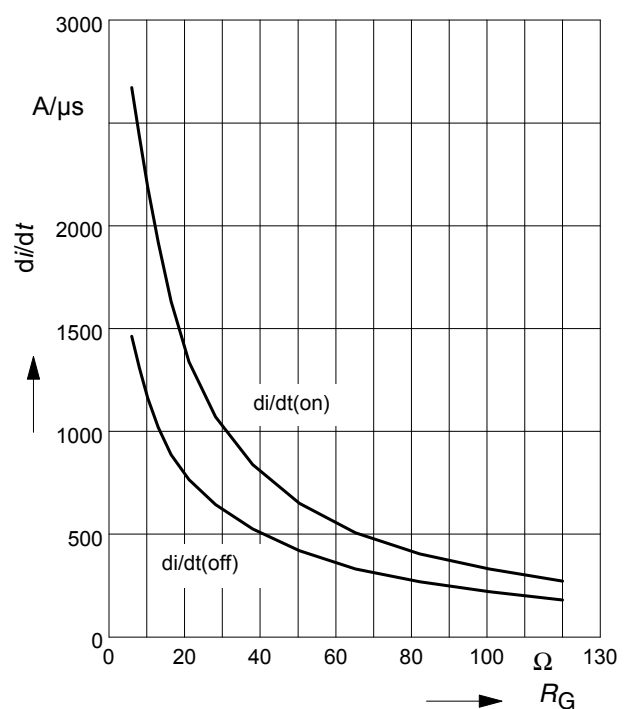



**17 Typ. drain source voltage slope**

$dv/dt = f(R_G)$ , inductive load,  $T_j = 125^\circ\text{C}$   
 par.:  $V_{DS}=380\text{V}$ ,  $V_{GS}=0/+13\text{V}$ ,  $I_D=7.3\text{A}$

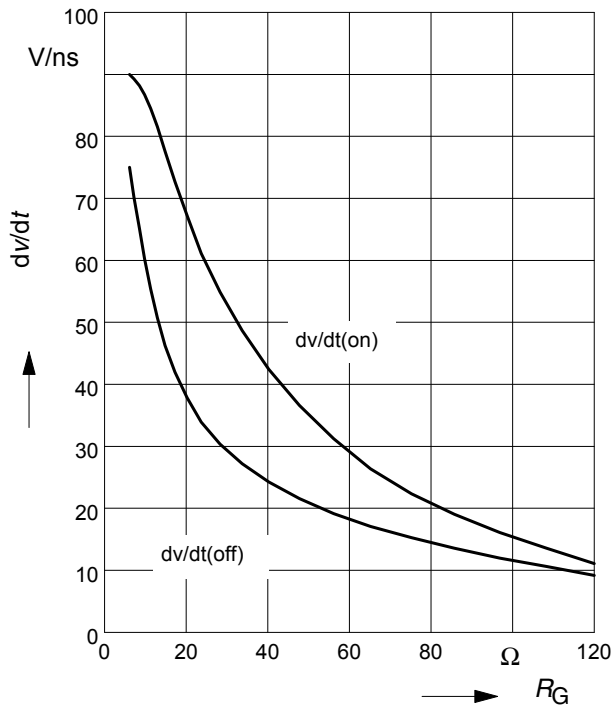

**18 Typ. switching losses**

$E = f(I_D)$ , inductive load,  $T_j=125^\circ\text{C}$   
 par.:  $V_{DS}=380\text{V}$ ,  $V_{GS}=0/+13\text{V}$ ,  $R_G=12\Omega$

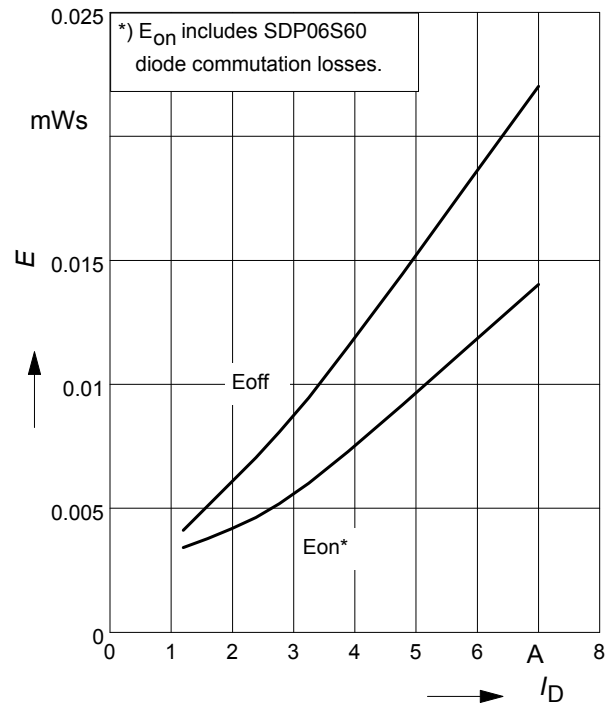

**19 Typ. switching losses**

$E = f(R_G)$ , inductive load,  $T_j=125^\circ\text{C}$   
 par.:  $V_{DS}=380\text{V}$ ,  $V_{GS}=0/+13\text{V}$ ,  $I_D=7.3\text{A}$

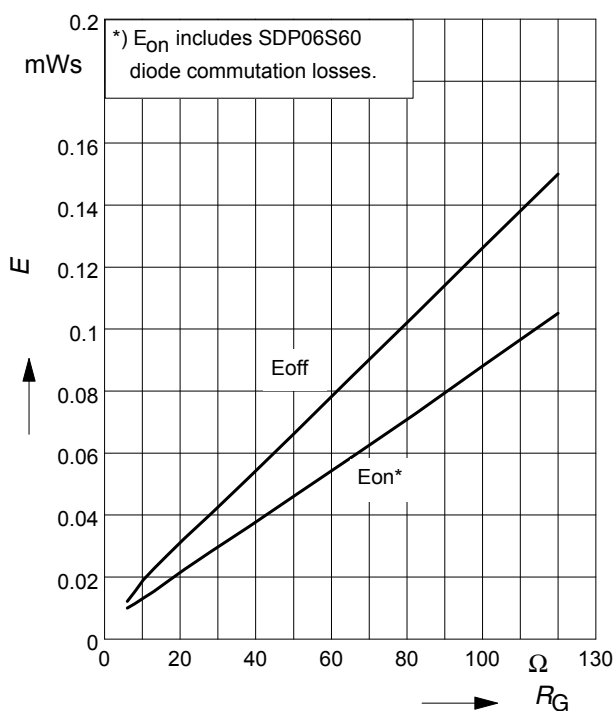

**20 Avalanche SOA**

$I_{AR} = f(t_{AR})$   
 par.:  $T_j \leq 150^\circ\text{C}$

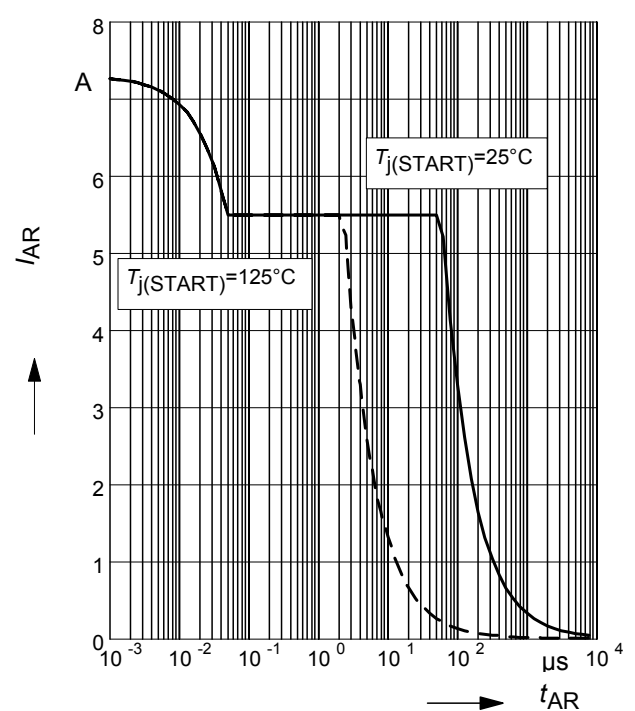

### 21 Avalanche energy

$$E_{AS} = f(T_j)$$

par.:  $I_D = 5.5 \text{ A}$ ,  $V_{DD} = 50 \text{ V}$

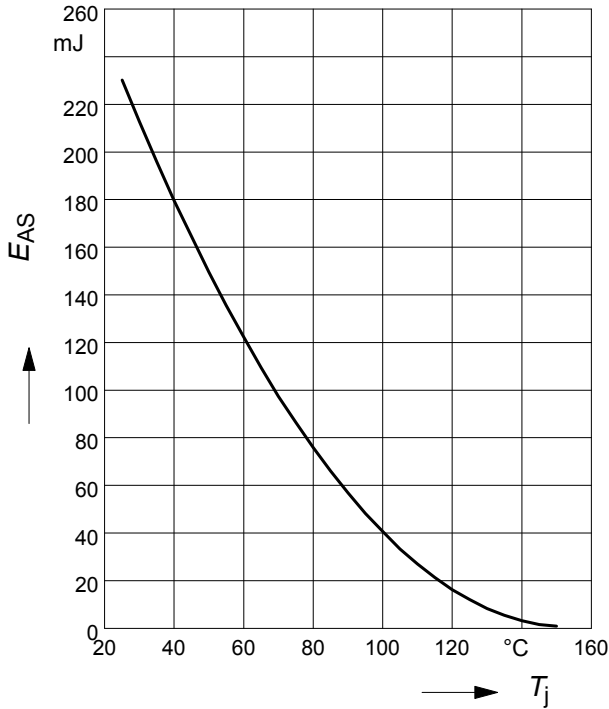

### 22 Drain-source breakdown voltage

$$V_{(BR)DSS} = f(T_j)$$

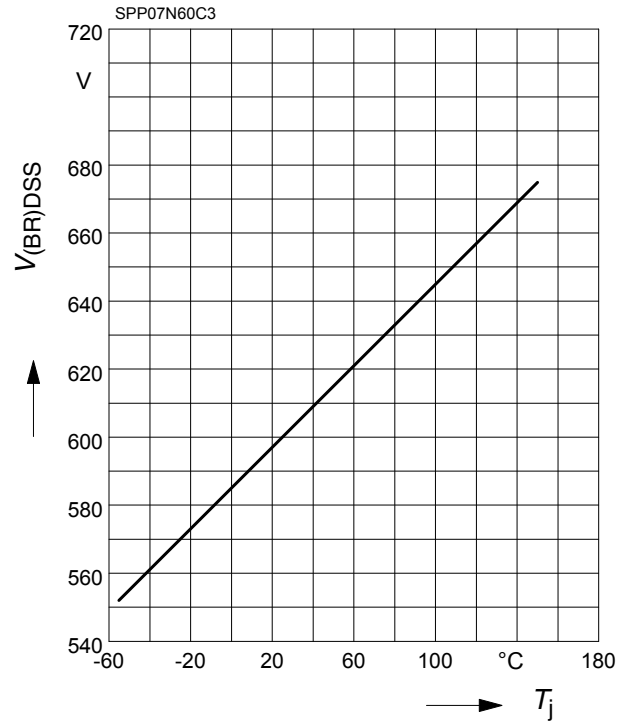

### 23 Avalanche power losses

$$P_{AR} = f(f)$$

parameter:  $E_{AR} = 0.5 \text{ mJ}$

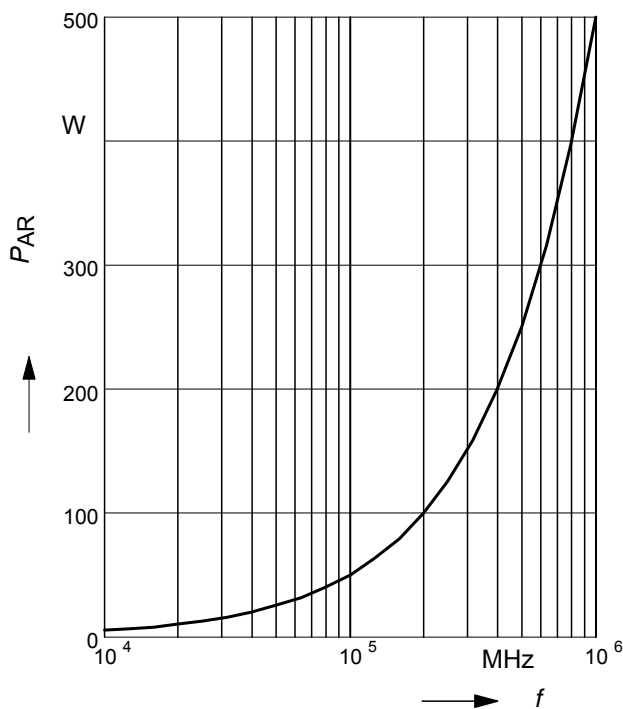

### 24 Typ. capacitances

$$C = f(V_{DS})$$

parameter:  $V_{GS} = 0 \text{ V}$ ,  $f = 1 \text{ MHz}$

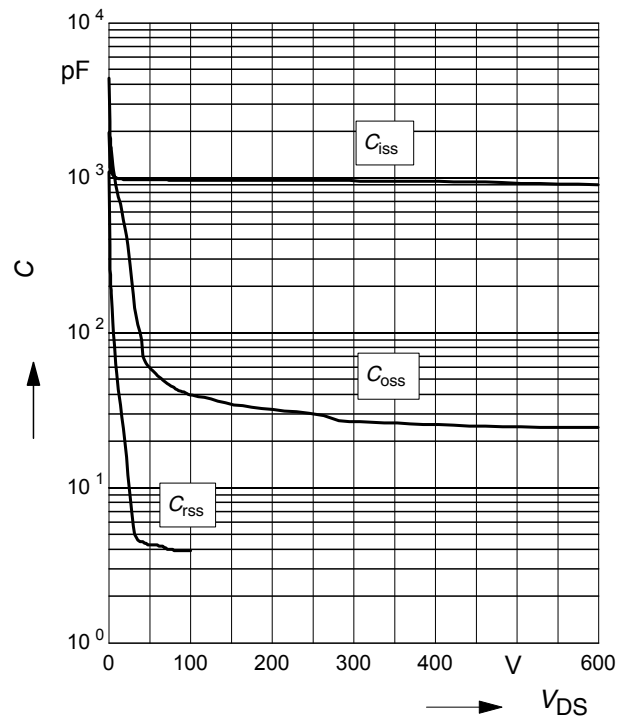

25 Typ.  $C_{oss}$  stored energy

$$E_{oss} = f(V_{DS})$$

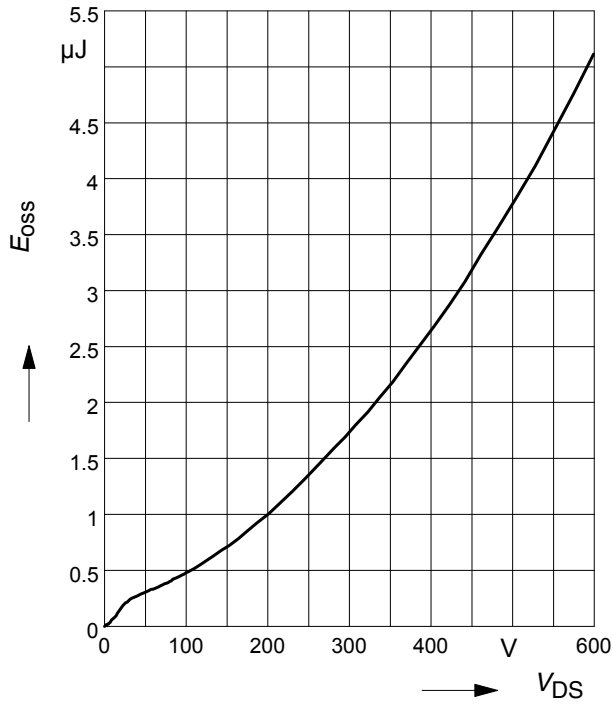

Definition of diodes switching characteristics

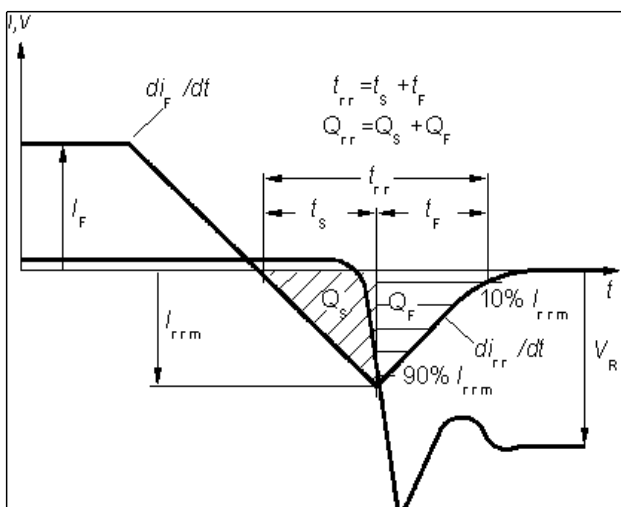

PG-TO220-3-1, PG-TO220-3-21 : Outline

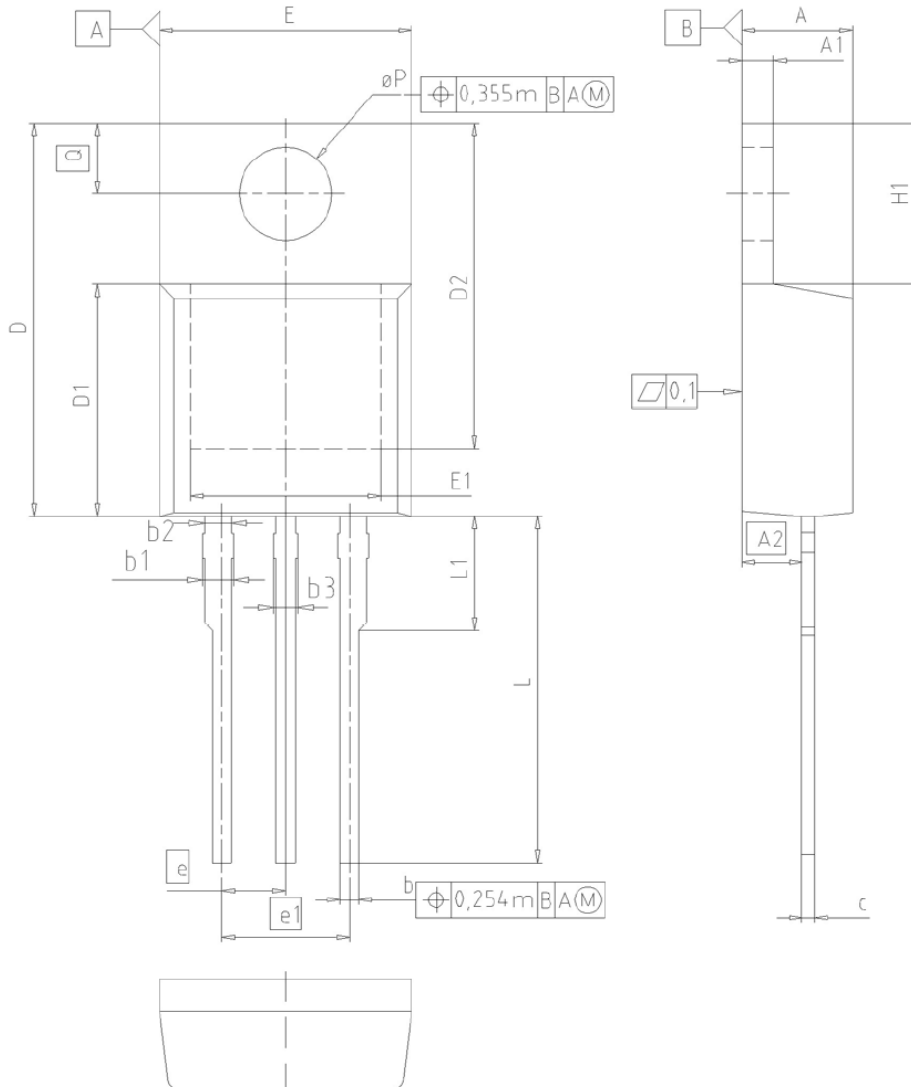

DIM	MILLIMETERS		INCHES	
	MIN	MAX	MIN	MAX
A	4.30	4.57	0.169	0.180
A1	1.17	1.40	0.046	0.055
A2	2.15	2.72	0.085	0.107
b	0.65	0.86	0.026	0.034
b1	0.95	1.40	0.037	0.055
b2	0.95	1.15	0.037	0.045
b3	0.65	1.15	0.026	0.045
c	0.33	0.60	0.013	0.024
D	14.81	15.95	0.583	0.628
D1	8.51	9.45	0.335	0.372
D2	12.19	13.10	0.480	0.516
E	9.70	10.36	0.382	0.408
E1	6.50	8.60	0.256	0.339
e	2.54		0.100	
e1	5.08		0.200	
N	3		3	
H1	5.90	6.90	0.232	0.272
L	13.00	14.00	0.512	0.551
L1	-	4.80	-	0.189
øP	3.60	3.89	0.142	0.153
Q	2.60	3.00	0.102	0.118

**DOCUMENT NO.**  
Z8B00003318

**SCALE**

**EUROPEAN PROJECTION**

**ISSUE DATE**  
23-08-2007

**REVISION**  
05

Outline PG-TO220 FullPAK

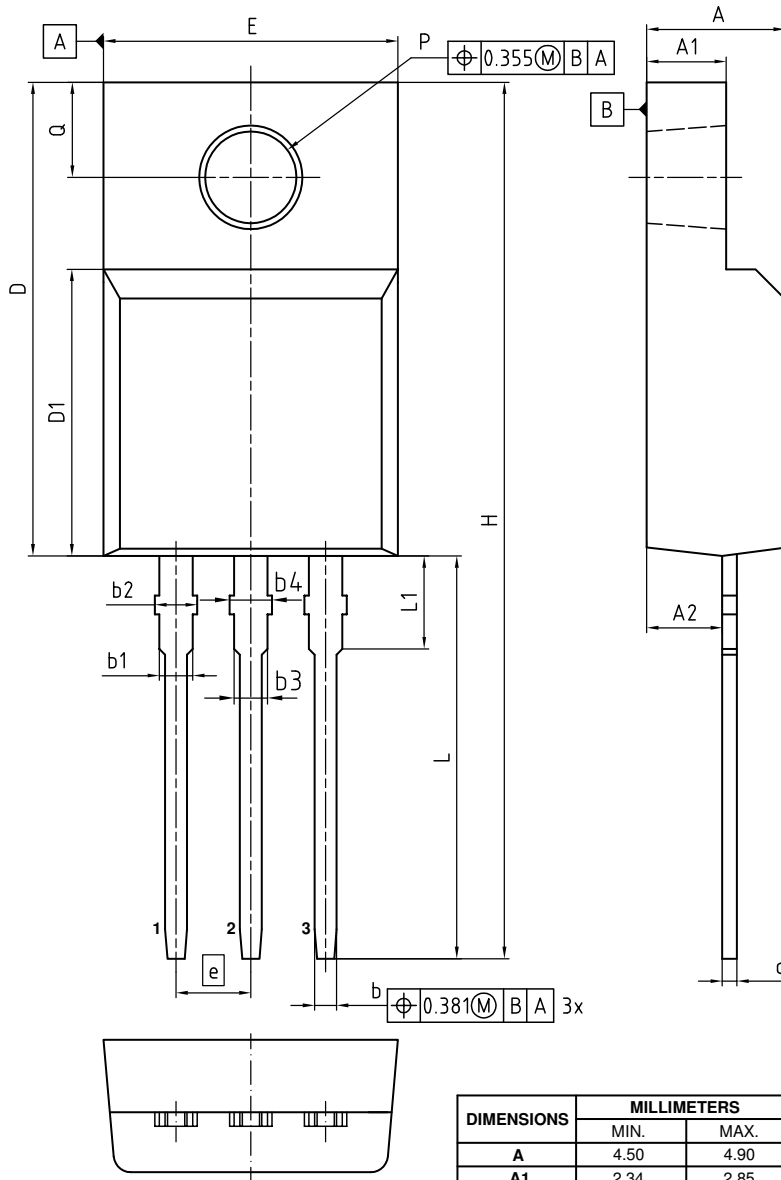

NOTES:  
ALL DIMENSIONS REFER TO JEDEC STANDARD TO-281  
AND DOES NOT INCLUDE MOLD FLASH, PROTRUSIONS  
OR GATE BURRS  
GATE BURRS ARE LESS THAN 0.5 mm

DIMENSIONS	MILLIMETERS	
	MIN.	MAX.
A	4.50	4.90
A1	2.34	2.85
A2	2.42	2.86
b	0.65	0.90
b1	0.95	1.38
b2	0.95	1.51
b3	0.65	1.38
b4	0.65	1.51
c	0.40	0.63
D	15.67	16.15
D1	8.97	9.83
E	10.00	10.65
e	2.54	
H	28.70	29.75
L	12.78	13.75
L1	2.83	3.45
øP	3.00	3.30
Q	3.15	3.50

<b>DOCUMENT NO.</b> Z8B00003319
<b>REVISION</b> 07
<b>SCALE 5:1</b> 0 1 2 3 4 5mm
<b>EUROPEAN PROJECTION</b> 
<b>ISSUE DATE</b> 27.01.2017

PG-TO-262-3-1/PG-TO262-3-21 (I<sup>2</sup>-PAK)

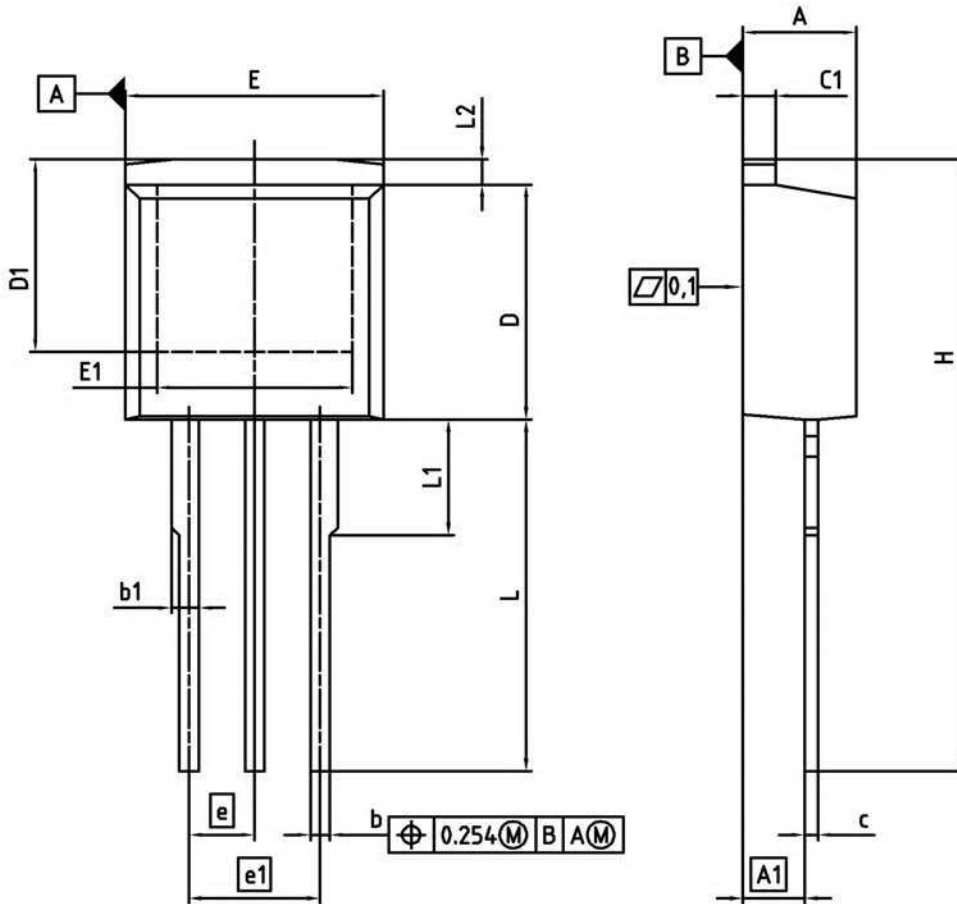

DIM	MILLIMETERS		INCHES	
	MIN	MAX	MIN	MAX
A	4.300	4.572	0.169	0.180
A1	2.150	2.718	0.085	0.107
b	0.650	0.864	0.026	0.034
b1	0.635	1.400	0.025	0.055
c	0.330	0.600	0.013	0.024
c1	1.170	1.400	0.046	0.055
D	8.509	9.450	0.335	0.372
D1	6.900	-	0.272	-
E	9.700	10.363	0.382	0.408
E1	6.500	8.600	0.256	0.339
e	2.540		0.100	
e1	5.080		0.200	
N	3		3	
L	13.000	14.000	0.512	0.551
L1	-	4.800	-	0.189
L2	-	1.727	-	0.068

REFERENCE  
JEDEC TO262

EUROPEAN PROJECTION

ISSUE DATE  
05-05-2006

FILE  
TO262\_1

# 600V CoolMOS™ C3 Power Transistor

## SPx07N60C3

### Revision History

SPx07N60C3

**Revision: 2018-02-27, Rev. 2.3**

Previous Revision

Revision	Date	Subjects (major changes since last revision)
3.3	2018-02-27	Outline PG-TO-220 FullPAK update

#### Trademarks of Infineon Technologies AG

AURIX™, C166™, CanPAK™, CIPOS™, CoolGaN™, CoolMOS™, CoolSET™, CoolSiC™, CORECONTROL™, CROSSAVE™, DAVE™, DI-POL™, DrBlade™, EasyPIM™, EconoBRIDGE™, EconoDUAL™, EconoPACK™, EconoPIM™, EiceDRIVER™, eupec™, FCOS™, HITFET™, HybridPACK™, Infineon™, ISOFACE™, IsoPACK™, i-Wafer™, MIPAQ™, ModSTACK™, my-d™, NovalithIC™, OmniTune™, OPTIGA™, OptiMOS™, ORIGA™, POWERCODE™, PRIMARION™, PrimePACK™, PrimeSTACK™, PROFET™, PRO-SIL™, RASIC™, REAL3™, ReverSave™, SatRIC™, SIEGET™, SiPMOS™, SmartLEWIS™, SOLID FLASH™, SPOC™, TEMPFET™, thinQ!™, TRENCHSTOP™, TriCore™.

Trademarks updated August 2015

#### Other Trademarks

All referenced product or service names and trademarks are the property of their respective owners.

#### We Listen to Your Comments

Any information within this document that you feel is wrong, unclear or missing at all? Your feedback will help us to continuously improve the quality of this document. Please send your proposal (including a reference to this document) to:

[erratum@infineon.com](mailto:erratum@infineon.com)

#### Published by

**Infineon Technologies AG**

**81726 München, Germany**

**© 2018 Infineon Technologies AG**

**All Rights Reserved.**

#### Legal Disclaimer

The information given in this document shall in no event be regarded as a guarantee of conditions or characteristics ("Beschaffensgarantie").

With respect to any examples, hints or any typical values stated herein and/or any information regarding the application of the product, Infineon Technologies hereby disclaims any and all warranties and liabilities of any kind, including without limitation warranties of non-infringement of intellectual property rights of any third party.

In addition, any information given in this document is subject to customer's compliance with its obligations stated in this document and any applicable legal requirements, norms and standards concerning customer's products and any use of the product of Infineon Technologies in customer's applications.

The data contained in this document is exclusively intended for technically trained staff. It is the responsibility of customer's technical departments to evaluate the suitability of the product for the intended application and the completeness of the product information given in this document with respect to such application.

#### Information

For further information on technology, delivery terms and conditions and prices please contact your nearest Infineon Technologies Office ([www.infineon.com](http://www.infineon.com)).

#### Warnings

Due to technical requirements, components may contain dangerous substances. For information on the types in question, please contact the nearest Infineon Technologies Office.

The Infineon Technologies component described in this Data Sheet may be used in life-support devices or systems and/or automotive, aviation and aerospace applications or systems only with the express written approval of Infineon Technologies, if a failure of such components can reasonably be expected to cause the failure of that life-support, automotive, aviation and aerospace device or system or to affect the safety or effectiveness of that device or system. Life support devices or systems are intended to be implanted in the human body or to support and/or maintain and sustain and/or protect human life. If they fail, it is reasonable to assume that the health of the user or other persons may be endangered.