

IFX25001

Low dropout voltage regulator



Features

- Output voltages: 3.3 V, 5.0 V
- Output current up to 400 mA
- Low current consumption
- Wide input voltage functional range up to 40 V / max. rating 45 V
- Low dropout voltage
- Output current limitation
- Reverse polarity protection
- Overtemperature shutdown
- Wide temperature range, -40°C to 125°C
- Green product (RoHS compliant)

Potential applications

- Manufacturing automation
- Appliances
- HDTV and game consoles
- Network routers



Product validation

Qualified for industrial applications according to the relevant tests of JEDEC.

Description

The IFX25001 is a low dropout linear voltage regulator available as 3.3 V and 5 V version. Capable of supplying continuous output currents up to 400 mA and offering a wide functional input voltage range up to 40 V the IFX25001 is suitable for a large variety of applications. In addition it is also protected against overload, short circuit and overtemperature conditions.

Type	Package	Marking
IFX25001 ME V33	PG-SOT223-4	25001B
IFX25001 TF V33	PG-TO252-3	2500133
IFX25001 TF V50	PG-TO252-3	2500150
IFX25001 TC V50	PG-TO263-3	25001V50

Block diagram

1 Block diagram

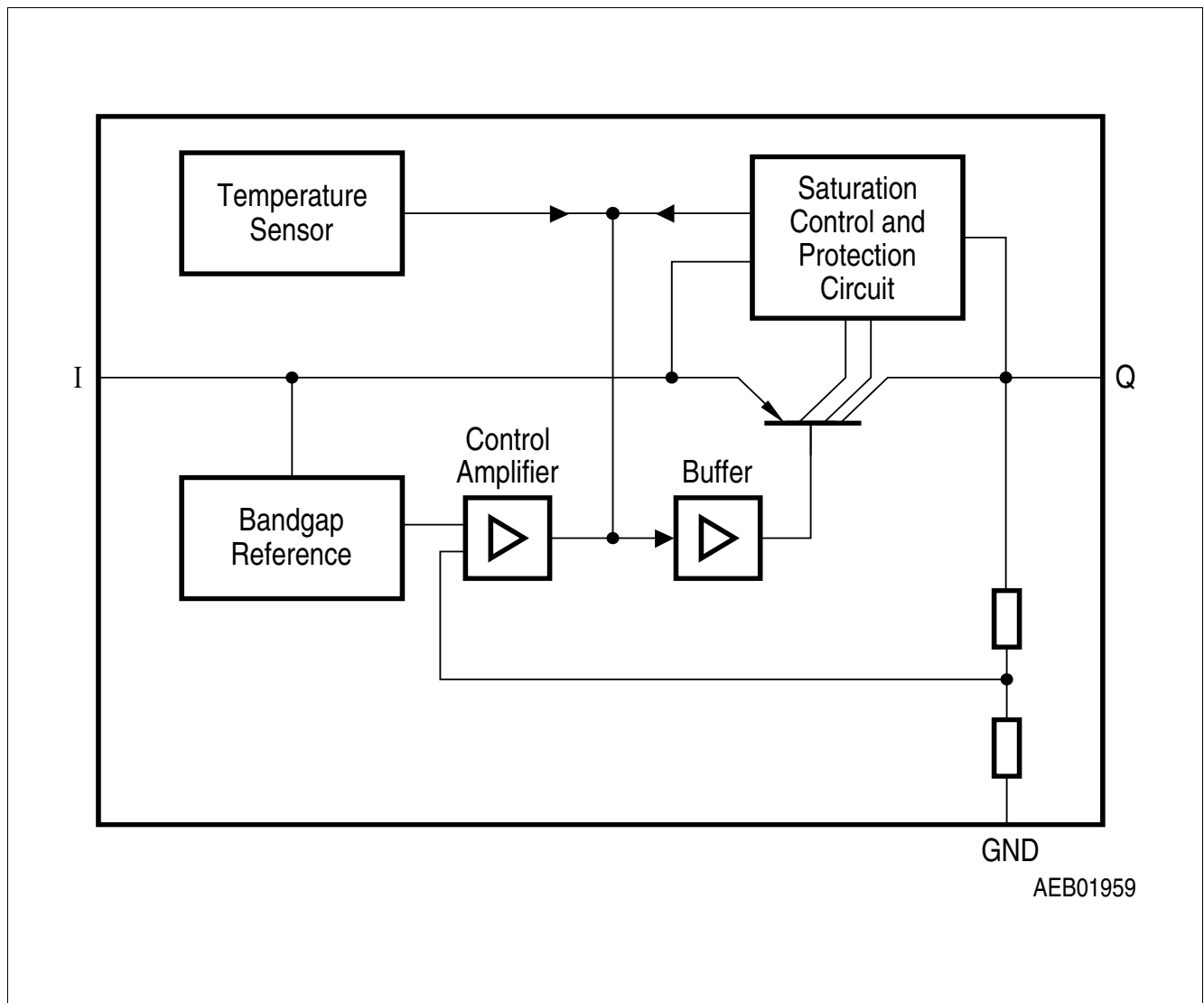

Figure 1 Block diagram

Pin configuration

2 Pin configuration

2.1 Pin assignment PG-SOT223-4, PG-TO252-3, PG-TO263-3

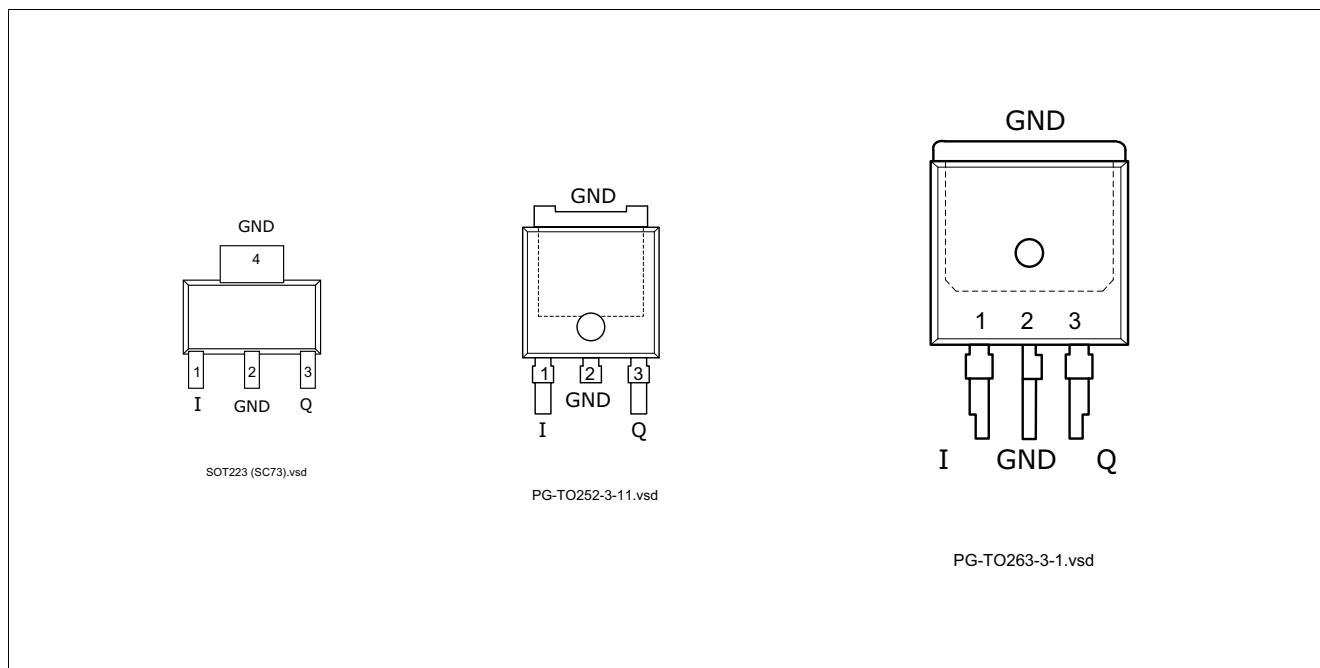

Figure 2 Pin Configuration (top view)

2.2 Pin definitions and functions PG-SOT223-4, PG-TO252-3, PG-TO263-3

Pin No.	Symbol	Function
1	I	Input connect Input pin to positive DC voltage source (e.g. battery); a small filter capacitor connected close to the Input pin and GND is recommended
2	GND	Ground internally connected to heat slug pin
3	Q	Output connect a capacitor close to the Output pin and GND according to the values specified in “Functional range” on Page 4
4 / Heat slug	GND	Heat Slug internally connected to GND pin; connect to heatsink to improve thermal performance

General product characteristics

3 General product characteristics

3.1 Absolute maximum ratings

Absolute maximum ratings¹⁾

$T_j = -40\text{ °C to }150\text{ °C}$; all voltages with respect to ground, (unless otherwise specified)

Pos.	Parameter	Symbol	Limit Values		Unit	Test Condition
			Min.	Max.		
Input I						
3.1.1	Voltage	V_I	-42	45	V	–
Output Q						
3.1.2	Voltage	V_Q	-1	40	V	–
Temperature						
3.1.3	Junction temperature	T_j	-40	150	°C	–
3.1.4	Storage temperature	T_{stg}	-50	150	°C	–

1) not subject to production test, specified by design

Note: Stresses above the ones listed here may cause permanent damage to the device. Exposure to absolute maximum rating conditions for extended periods may affect device reliability.

Note: Integrated protection functions are designed to prevent IC destruction under fault conditions described in the data sheet. Fault conditions are considered as “outside” normal operating range. Protection functions are not designed for continuous repetitive operation.

3.2 Functional range

Pos.	Parameter	Symbol	Limit Values		Unit	Remarks
			Min.	Max.		
3.2.1	Input voltage	V_I	4.7	40	V	IFX25001 ME V33 IFX25001 TF V33
3.2.2		V_I	5.5	40	V	IFX25001 TF V50 IFX25001 TC V50
3.2.5	Output capacitor's	C_Q	22	–	µF	¹⁾
3.2.6	Requirements for stability	$ESR(C_Q)$	–	3	Ω	²⁾
3.2.7	Junction temperature	T_j	-40	125	°C	–

1) the minimum output capacitance requirement is applicable for a worst case capacitance tolerance of 30%

2) relevant ESR value at $f = 10\text{ kHz}$

Note: Within the functional or operating range, the IC operates as described in the circuit description. The electrical characteristics are specified within the conditions given in the Electrical Characteristics table.

General product characteristics

3.3 Thermal resistance

Note: This thermal data was generated in accordance with JEDEC JESD51 standards. For more information, go to www.jedec.org.

Pos.	Parameter	Symbol	Limit Values			Unit	Conditions
			Min.	Typ.	Max.		
PG-TO252-3							
3.3.1	Junction to case ¹⁾	R_{thJC}	–	4	–	K/W	measured to heat slug
3.3.2	Junction to ambient ¹⁾	R_{thJA}	–	27	–	K/W	²⁾
3.3.3		R_{thJA}	–	57	–	K/W	300 mm ² heatsink area ³⁾
3.3.4		R_{thJA}	–	42	–	K/W	600 mm ² heatsink area ³⁾
PG-TO263-3							
3.3.5	Junction to case ¹⁾	R_{thJC}	–	4	–	K/W	measured to heat slug
3.3.6	Junction to ambient ¹⁾	R_{thJA}	–	22	–	K/W	²⁾
3.3.7		R_{thJA}	–	42	–	K/W	300 mm ² heatsink area ³⁾
3.3.8		R_{thJA}	–	33	–	K/W	600 mm ² heatsink area ³⁾
PG-SOT223-4							
3.3.10	Junction to case ¹⁾	R_{thJC}	–	25	–	K/W	measured to heat slug
3.3.11	Junction to ambient ²⁾	R_{thJA}	–	51	–	K/W	²⁾
3.3.12		R_{thJA}	–	75	–	K/W	300 mm ² heatsink area ³⁾
3.3.13		R_{thJA}	–	63	–	K/W	600 mm ² heatsink area ³⁾

- 1) Not subject to production test, specified by design.
- 2) Specified R_{thJA} value is according to Jedec JESD51-2,-5,-7 at natural convection on FR4 2s2p board; The Product (Chip+Package) was simulated on a 76.2 x 114.3 x 1.5 mm³ board with 2 inner copper layers (2 x 70µm Cu, 2 x 35µm Cu). Where applicable a thermal via array under the exposed pad contacted the first inner copper layer.
- 3) Specified R_{thJA} value is according to Jedec JESD 51-3 at natural convection on FR4 1s0p board; The Product (Chip+Package) was simulated on a 76.2 x 114.3 x 1.5 mm³ board with 1 copper layer (1 x 70µm Cu).

Electrical characteristics

4 Electrical characteristics

4.1 Electrical characteristics voltage regulator

Electrical Characteristics

$V_I = 13.5\text{ V}$; $T_j = -40\text{ °C}$ to 125 °C ; all voltages with respect to ground (unless otherwise specified)

Pos.	Parameter	Symbol	Limit Values			Unit	Measuring Condition
			Min.	Typ.	Max.		

Output Q

4.1.1	Output voltage	V_Q	4.8	5.0	5.2	V	IFX25001 TF V50 IFX25001 TC V50 $5\text{ mA} < I_Q < 400\text{ mA}$ $6\text{ V} < V_I < 28\text{ V}$
4.1.2	Output voltage	V_Q	3.17	3.3	3.44	V	IFX25001 ME V33, IFX25001 TF V33 $5\text{ mA} < I_Q < 400\text{ mA}$ $4.7\text{ V} < V_I < 28\text{ V}$
4.1.4	Dropout voltage	V_{dr}	-	250	500	mV	IFX25001 TF V50, IFX25001 TC V50, $I_Q = 250\text{ mA}$ $V_{dr} = V_I - V_Q$ ¹⁾
4.1.5	Dropout voltage	V_{dr}	-	0.7	1.2	V	IFX25001 ME V33, IFX25001 TF V33; $I_Q = 300\text{ mA}$ $V_{dr} = V_I - V_Q$ ¹⁾
4.1.7	Load regulation	$\Delta V_{Q,lo}$	-	20	50	mV	IFX25001 TF V50, IFX25001 TC V50, $I_Q = 5\text{ mA}$ to 400 mA $V_I = 6\text{ V}$
4.1.9	Load regulation	$\Delta V_{Q,lo}$	-	40	70	mV	IFX25001 ME V33, IFX25001 TF V33, $I_Q = 5\text{ mA}$ to 300 mA $V_I = 6\text{ V}$
4.1.10	Line regulation	$\Delta V_{Q,li}$	-	10	25	mV	$V_I = 12\text{ V}$ to 32 V $I_Q = 5\text{ mA}$
4.1.11	Output current limitation	I_Q	400	600	1100	mA	¹⁾
4.1.12	Power supply ripple rejection ²⁾	$PSRR$	-	60	-	dB	$f_r = 100\text{ Hz}$; $V_r = 0.5\text{ Vpp}$
4.1.13	Temperature output voltage drift ²⁾	$\frac{dV_Q}{dT}$	-	0.5	-	mV/K	-
4.1.14	Overtemperature shutdown threshold	$T_{j,sd}$	151	-	200	°C	T_j increasing ²⁾

Current Consumption

4.1.15	Quiescent current $I_q = I_I - I_Q$	I_q	-	100	220	µA	$I_Q = 1\text{ mA}$
--------	--	-------	---	-----	-----	----	---------------------

Electrical characteristics

Electrical Characteristics

$V_I = 13.5 \text{ V}$; $T_j = -40 \text{ °C}$ to 125 °C ; all voltages with respect to ground (unless otherwise specified)

Pos.	Parameter	Symbol	Limit Values			Unit	Measuring Condition
			Min.	Typ.	Max.		
4.1.16	Current consumption	I_q	-	8	15	mA	$I_Q = 250 \text{ mA}$
4.1.17	$I_q = I_I - I_Q$	I_q	-	20	30	mA	$I_Q = 400 \text{ mA}$

- 1) Measured when the output voltage V_Q has dropped 100 mV from the nominal value obtained at $V_I = 13.5 \text{ V}$.
- 2) not subject to production test, specified by design

Electrical characteristics

4.2 Typical performance characteristics voltage regulator (V50 variants)

Dropout voltage V_{dr} versus output current I_Q

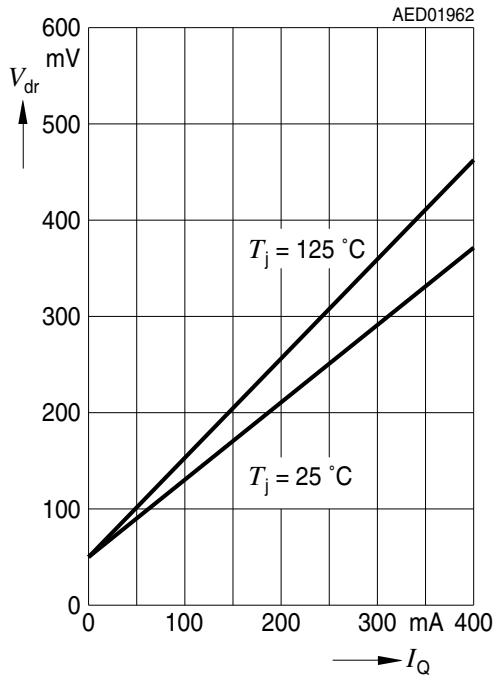

Output current I_Q versus input voltage V_I

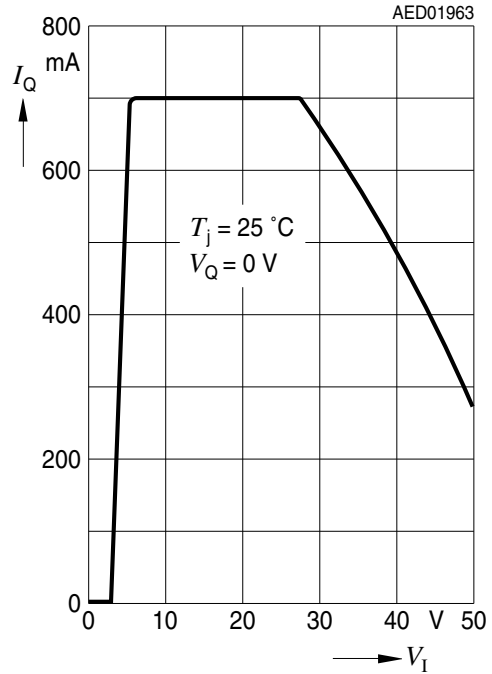

Current consumption I_q versus output current I_Q (high load)

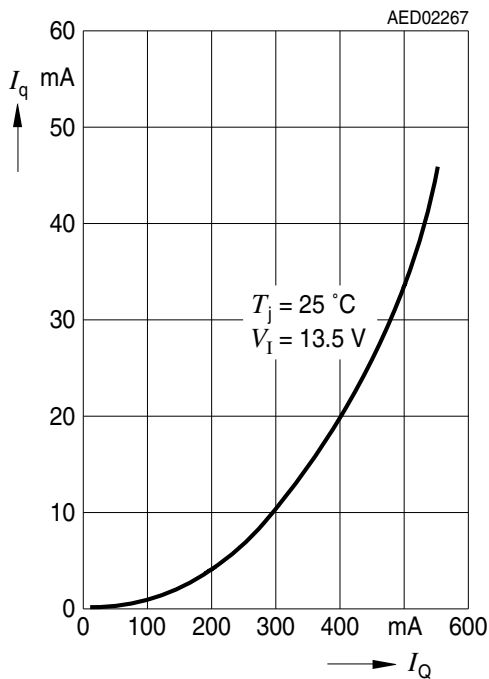

Current consumption I_q versus output current I_Q (low load)

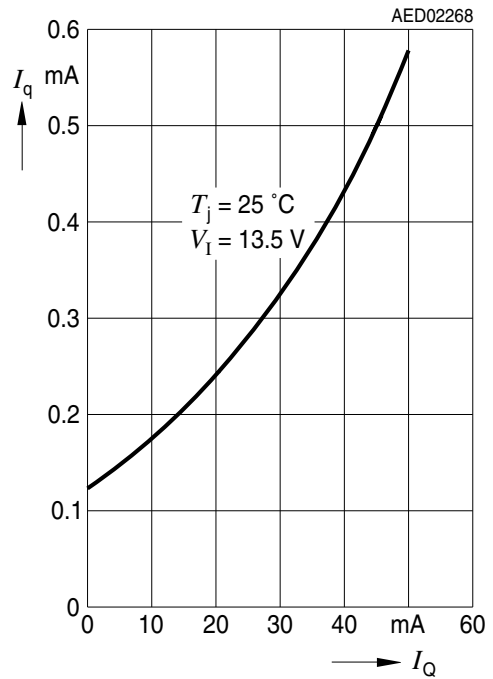

Electrical characteristics

4.2.1 Typical performance characteristics voltage regulator (V50 variants)

Output voltage V_Q versus junction temperature T_j

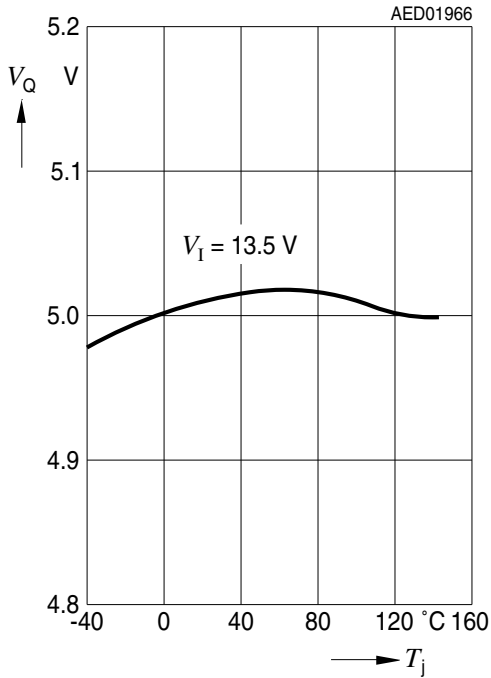

Current consumption I_q versus input voltage V_I

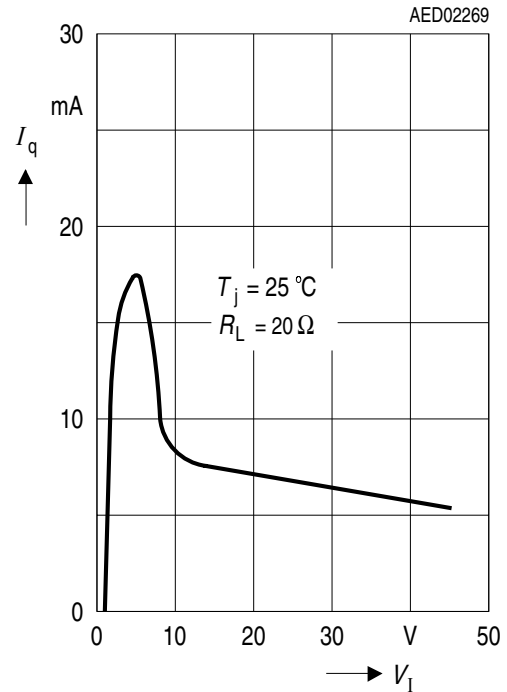

Output voltage V_Q versus input voltage V_I

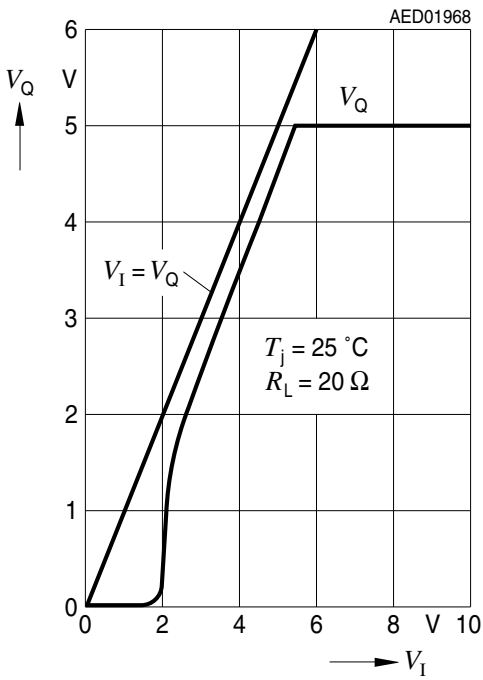

Input current I_I versus input voltage V_I

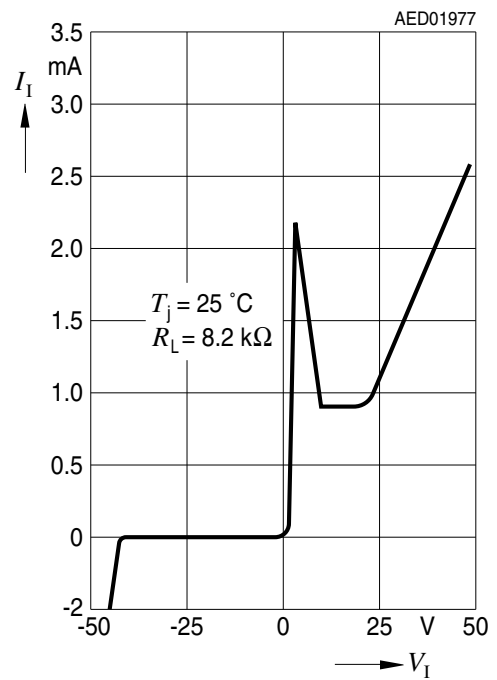

Electrical characteristics

4.2.2 Typical performance characteristics voltage regulator (V33 variants)

Output voltage V_Q versus junction temperature T_j

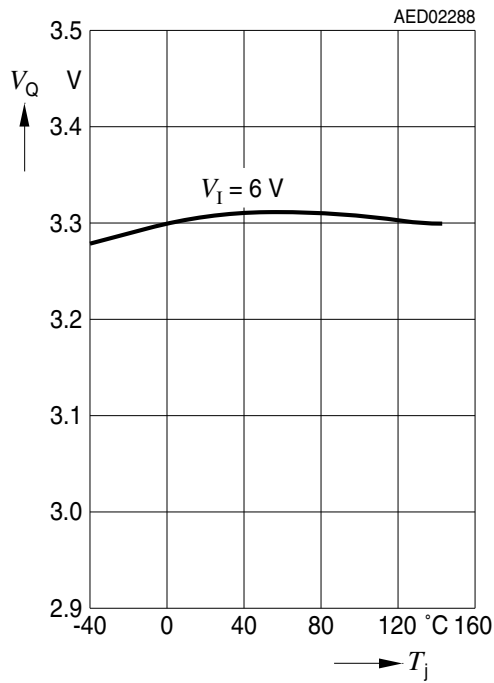

Input current I_I versus input voltage V_I

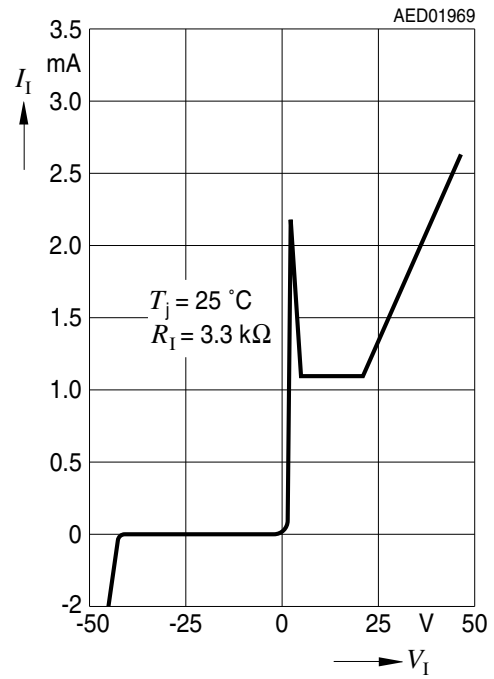

Electrical characteristics

4.2.3 Typical performance characteristics voltage regulator (V33 variants)

Current consumption I_q versus output current I_Q (Low Load)

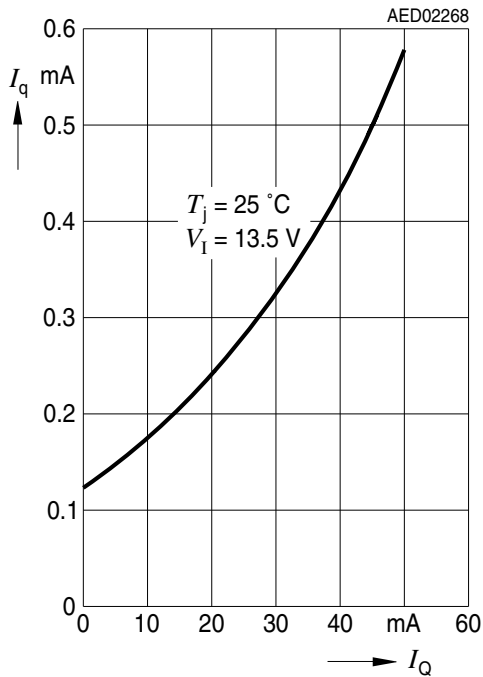

Current consumption I_q versus output current I_Q high load)

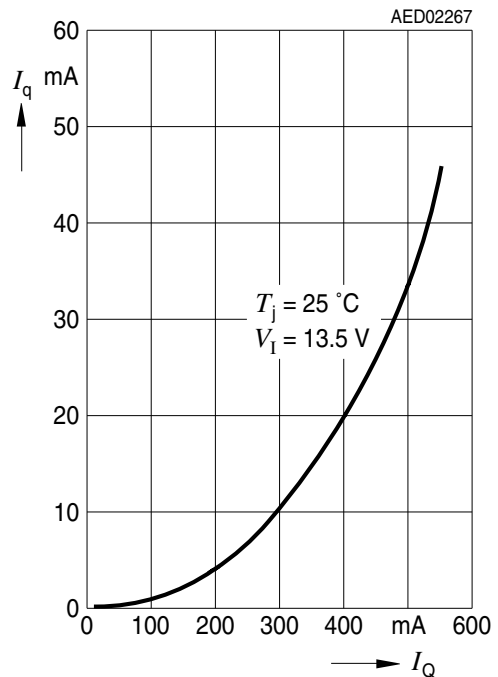

Output current I_Q versus input voltage V_I

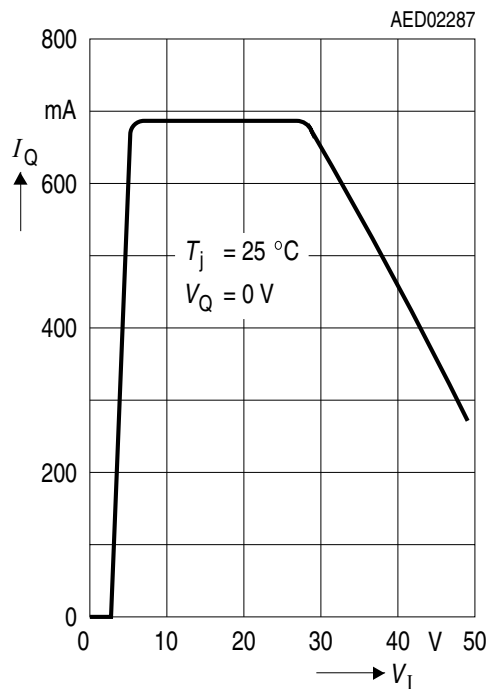

5 Package information

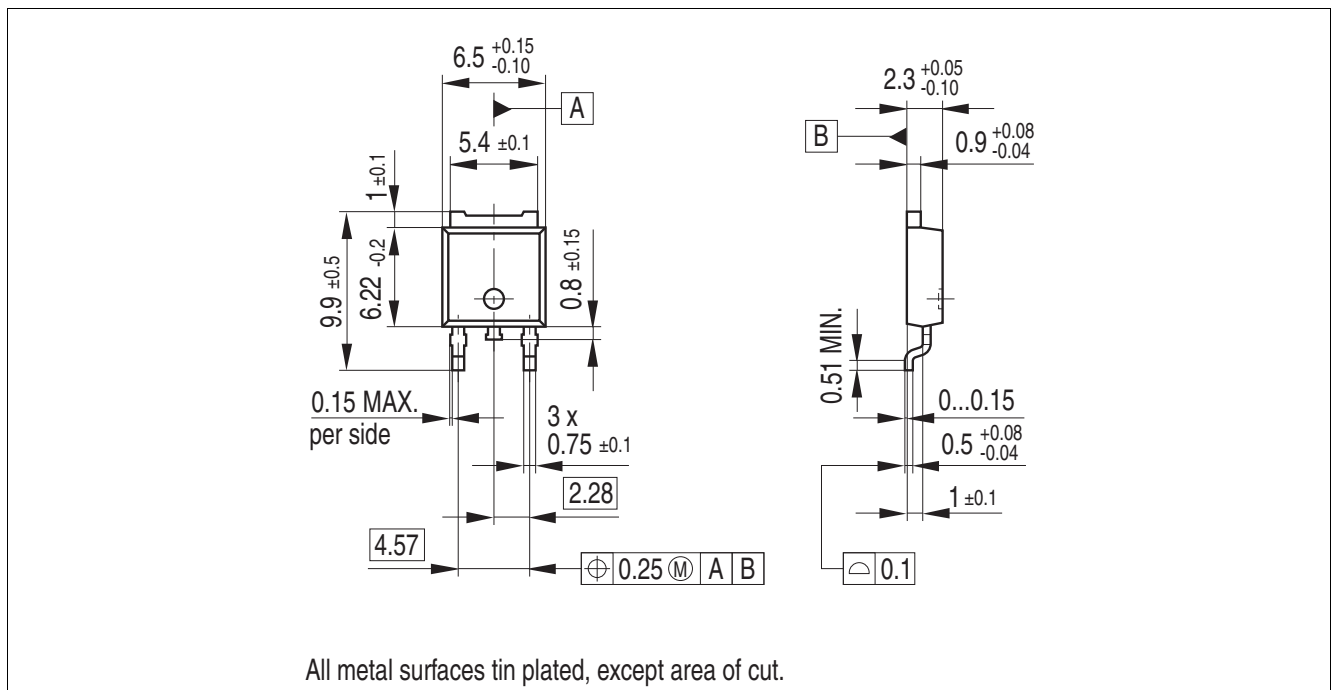

Figure 3 PG-T0252-3¹⁾

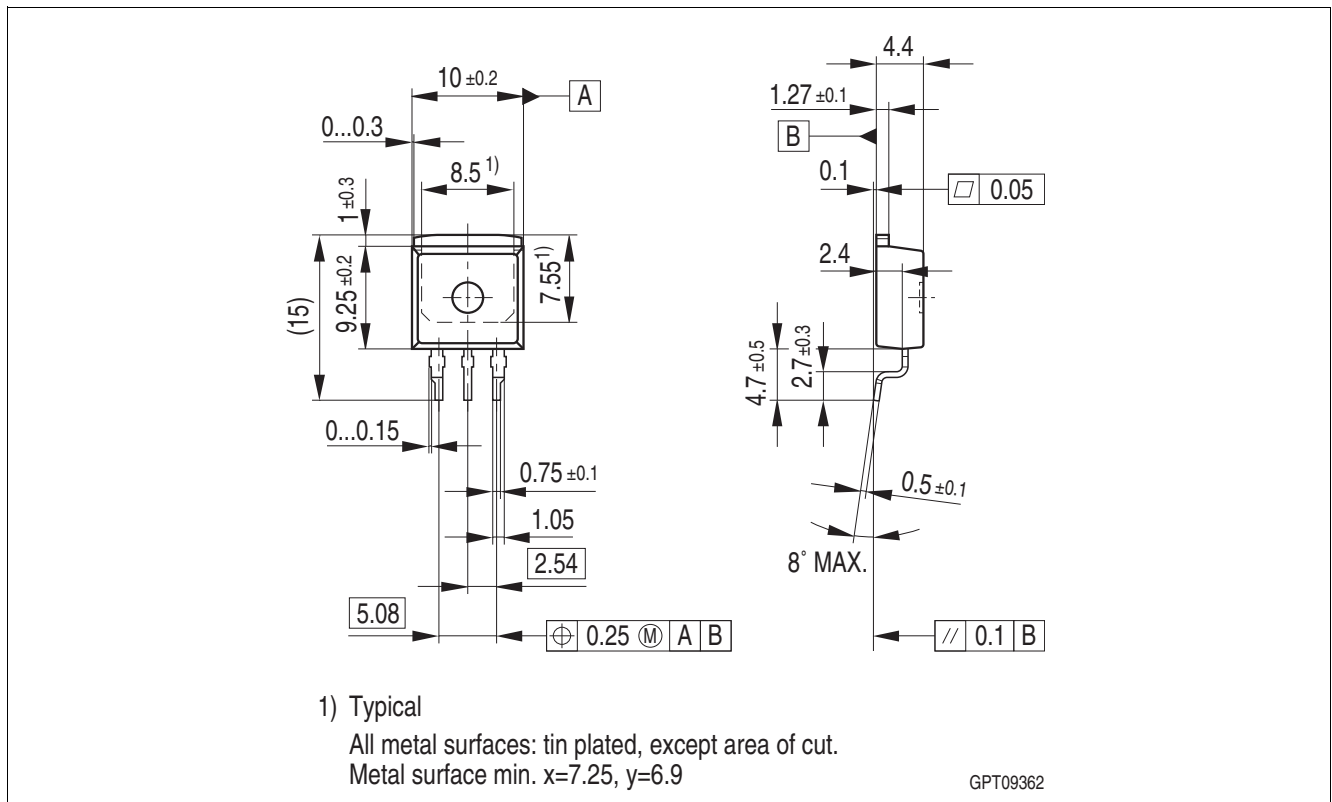

Figure 4 PG-T0263-3¹⁾

1) Dimensions in mm

Package information

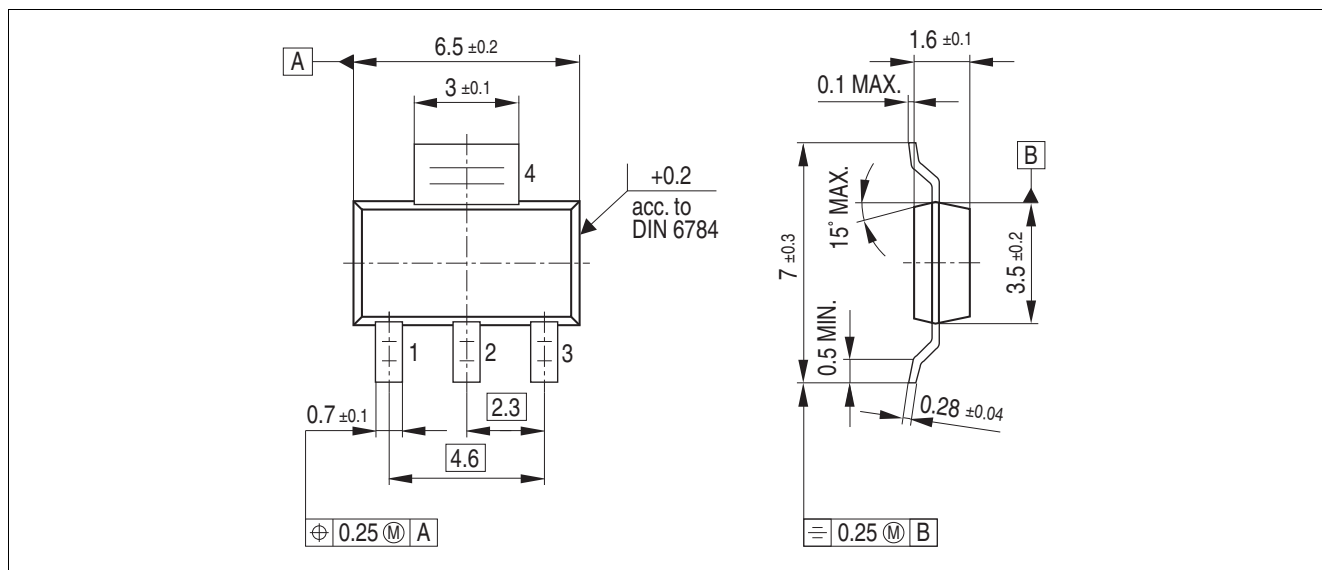

Figure 5 PG-SOT223-4¹⁾

Green Product (RoHS compliant)

To meet the world-wide customer requirements for environmentally friendly products and to be compliant with government regulations the device is available as a green product. Green products are RoHS-Compliant (i.e Pb-free finish on leads and suitable for Pb-free soldering according to IPC/JEDEC J-STD-020).

Further information on packages

<https://www.infineon.com/packages>

Revision history

6 Revision history

Table 1 Revision history

Revision	Date	Changes
1.10	2019-04-02	- Discontinued product variants removed from data sheet - Editorial changes
1.02	2009-05-20	- Editorial change (fig. 2)
1.01	2009-05	- Coverpage changed - Overview page: Inserted reference statement to TLE/TLF series
1.00	2009-04-28	- Initial release

Trademarks

All referenced product or service names and trademarks are the property of their respective owners.

Edition 2019-04-02

Published by

Infineon Technologies AG

81726 Munich, Germany

© 2019 Infineon Technologies AG.

All Rights Reserved.

Do you have a question about any aspect of this document?

Email: erratum@infineon.com

Z8F65126092

IMPORTANT NOTICE

The information given in this document shall in no event be regarded as a guarantee of conditions or characteristics ("Beschaffenheitsgarantie").

With respect to any examples, hints or any typical values stated herein and/or any information regarding the application of the product, Infineon Technologies hereby disclaims any and all warranties and liabilities of any kind, including without limitation warranties of non-infringement of intellectual property rights of any third party.

In addition, any information given in this document is subject to customer's compliance with its obligations stated in this document and any applicable legal requirements, norms and standards concerning customer's products and any use of the product of Infineon Technologies in customer's applications.

The data contained in this document is exclusively intended for technically trained staff. It is the responsibility of customer's technical departments to evaluate the suitability of the product for the intended application and the completeness of the product information given in this document with respect to such application.

For further information on technology, delivery terms and conditions and prices, please contact the nearest Infineon Technologies Office (www.infineon.com).

Please note that this product is not qualified according to the AEC Q100 or AEC Q101 documents of the Automotive Electronics Council.

WARNINGS

Due to technical requirements products may contain dangerous substances. For information on the types in question please contact your nearest Infineon Technologies office.

Except as otherwise explicitly approved by Infineon Technologies in a written document signed by authorized representatives of Infineon Technologies, Infineon Technologies' products may not be used in any applications where a failure of the product or any consequences of the use thereof can reasonably be expected to result in personal injury.