

NZL5V6AXV3T1 Series

ESD Protection Diode

Dual Common Anode

These dual monolithic silicon ESD protection diodes are intended for use in voltage and ESD sensitive equipment such as computers, printers, business machines, communication systems, medical equipment and other applications. Their dual junction common anode design protects two separate lines using only one package. These devices are ideal for situations where board space is at a premium.

Specification Features:

- SC-89 Package Allows Either Two Separate Unidirectional Configurations or a Single Bidirectional Configuration
- ESD Rating of Class N (exceeding 16 kV) per the Human Body Model
- Meets IEC61000-4-2 Level 4
- Low Leakage < 5.0 μ A
- SZ Prefix for Automotive and Other Applications Requiring Unique Site and Control Change Requirements; AEC-Q101 Qualified and PPAP Capable
- These Devices are Pb-Free, Halogen Free/BFR Free and are RoHS Compliant

Mechanical Characteristics:

CASE: Void-free, Transfer-molded, Thermosetting Plastic Epoxy Meets UL 94, V-0

LEAD FINISH: 100% Matte Sn (Tin)

MOUNTING POSITION: Any

QUALIFIED MAX REFLOW TEMPERATURE: 260°C Device Meets MSL 1 Requirements



ON Semiconductor®

www.onsemi.com

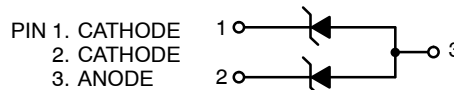

SC-89
CASE 463C
STYLE 4

MARKING DIAGRAM

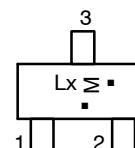

- L = Device Code
- x = Specific Device
- M = Date Code
- = Pb-Free Package

(Note: Microdot may be in either location)

ORDERING INFORMATION

Device	Package	Shipping†
NZL5V6AXV3T1G	SC-89	3000/Tape & Reel
SZNZL5V6AXV3T1G	SC-89	3000/Tape & Reel
NZL6V8AXV3T1G	SC-89	3000/Tape & Reel
SZNZL6V8AXV3T1G	SC-89	3000/Tape & Reel
NZL6V8AXV3T3G	SC-89	10000/Tape & Reel
SZNZL6V8AXV3T3G	SC-89	10000/Tape & Reel
NZL7V5AXV3T1G	SC-89	3000/Tape & Reel
SZNZL7V5AXV3T1G	SC-89	3000/Tape & Reel

†For information on tape and reel specifications, including part orientation and tape sizes, please refer to our Tape and Reel Packaging Specification Brochure, BRD8011/D.

DEVICE MARKING INFORMATION

See specific marking information in the device marking column of the table on page 2 of this data sheet.

NZL5V6AXV3T1 Series

MAXIMUM RATINGS

Rating	Symbol	Value	Unit
Total Power Dissipation on FR-5 Board (Note 1) @ $T_A = 25^\circ\text{C}$ Derate above 25°C	P_D	240 1.9	mW mW/ $^\circ\text{C}$
Thermal Resistance Junction to Ambient	$R_{\theta JA}$	525	$^\circ\text{C/W}$
Junction and Storage Temperature Range	T_J, T_{stg}	-55 to +150	$^\circ\text{C}$
Lead Solder Temperature – Maximum (10 Second Duration)	T_L	260	$^\circ\text{C}$
IEC61000-4-2 Contact IEC61000-4-2 Air	ESD	10 10	kV

Stresses exceeding those listed in the Maximum Ratings table may damage the device. If any of these limits are exceeded, device functionality should not be assumed, damage may occur and reliability may be affected.

1. FR-5 board with minimum recommended mounting pad.

*Other voltages may be available upon request.

ELECTRICAL CHARACTERISTICS

($T_A = 25^\circ\text{C}$ unless otherwise noted)

UNIDIRECTIONAL (Circuit tied to Pins 1 and 3 or 2 and 3)

Symbol	Parameter
V_{RWM}	Working Peak Reverse Voltage
I_R	Maximum Reverse Leakage Current @ V_{RWM}
V_{BR}	Breakdown Voltage @ I_T
I_T	Test Current
I_F	Forward Current
V_F	Forward Voltage @ I_F

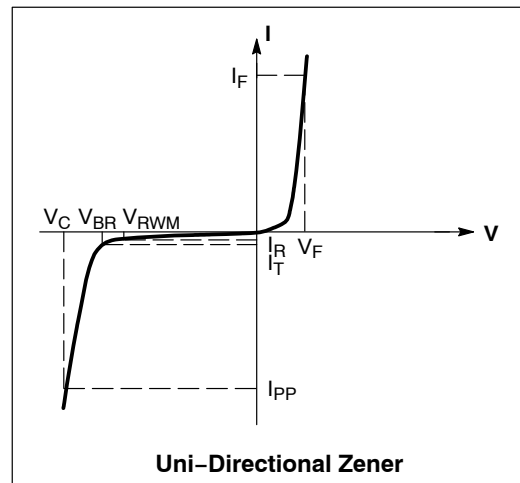

ELECTRICAL CHARACTERISTICS ($T_A = 25^\circ\text{C}$ unless otherwise noted, $V_F = 0.9\text{ V Max}$ @ $I_F = 10\text{ mA}$ for all types)

UNIDIRECTIONAL (Circuit tied to Pins 1 and 3 or Pins 2 and 3)

Device	Device Marking	Breakdown Voltage						Surge			
		V_{RWM} V	I_R @ V_{RWM} μA	V_{BR} (Note 2) (V)			@ I_{zT} mA	V_C (V) @ $I_{PP} = 1.0$ A †	V_C (V) @ Max I_{PP}^\dagger	Max I_{PP} (A) †	P_{pk} (W) †
				Min	Nom	Max		Typ	Max		
NZL5V6AXV3T1	L0	3.0	5.0	5.32	5.6	5.88	5.0	7.0	10.1	4.8	50
NZL6V8AXV3T1	L2	4.5	1.0	6.46	6.8	7.14	5.0	7.9	11.9	6.7	73
NZL6V8AXV3T3	L2	4.5	1.0	6.46	6.8	7.14	5.0	7.9	11.9	6.7	73
NZL7V5AXV3T1	L3	5.0	1.0	7.12	7.5	7.88	5.0	8.8	13.5	5.7	75

2. V_{BR} measured at pulse test current I_T at an ambient temperature of 25°C .

† Surge current waveform per Figure 5.

NZL5V6AXV3T1 Series

TYPICAL CHARACTERISTICS

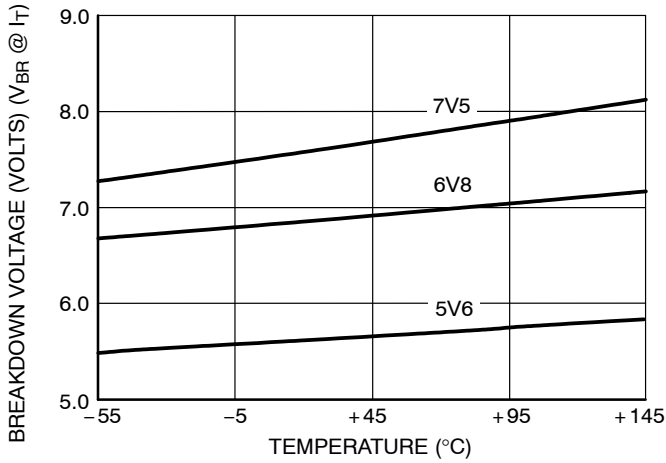

Figure 1. Typical Breakdown Voltage versus Temperature

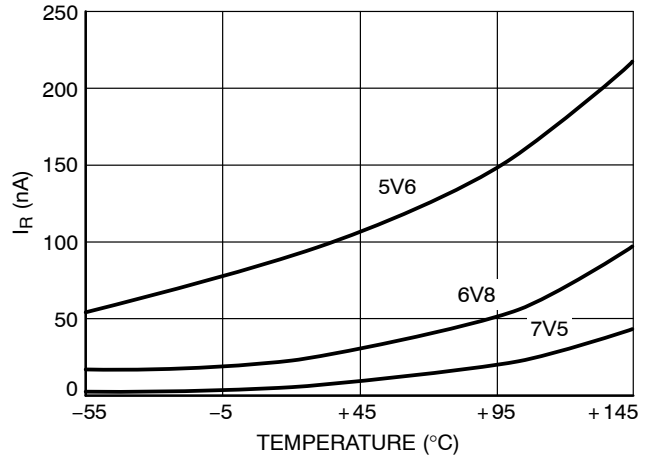

Figure 2. Typical Leakage Current versus Temperature

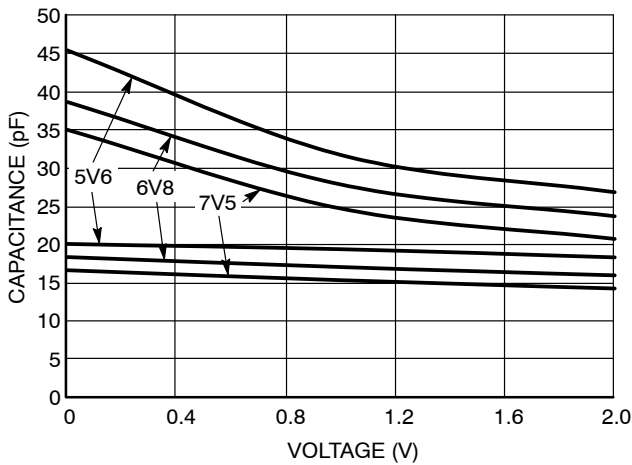

Figure 3. Typical Capacitance versus Bias Voltage
(Upper curve for each part is unidirectional mode, lower curve is bidirectional mode)

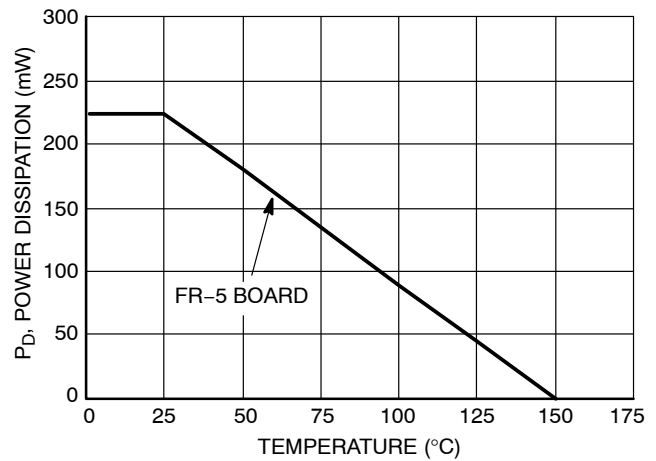

Figure 4. Steady State Power Derating Curve

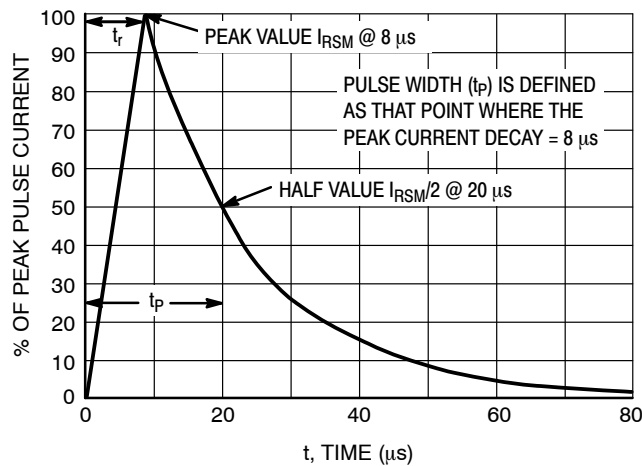

Figure 5. 8 x 20 μs Pulse Waveform

NZL5V6AXV3T1 Series

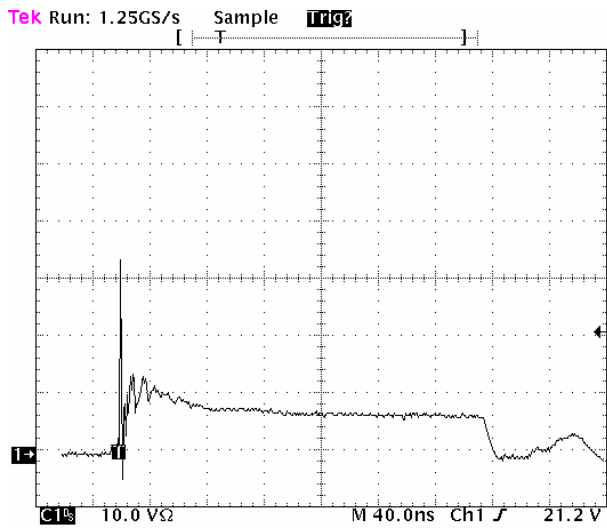

Figure 6. Positive 8 kV contact per IEC 6100-4-2
- NZL6V8AXV3T1G

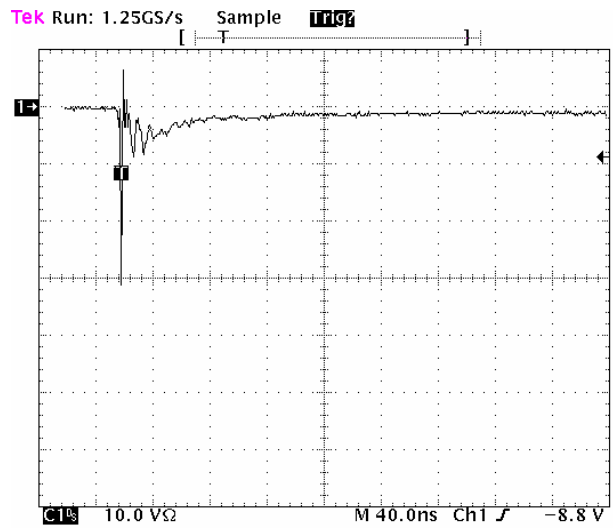

Figure 7. Negative 8 kV contact per IEC 6100-4-2
- NZL6V8AXV3T1G

NZL5V6AXV3T1 Series

TYPICAL COMMON ANODE APPLICATIONS

A dual junction common anode design in an SC-89 package protects two separate lines using only one package. This adds flexibility and creativity to PCB design especially

when board space is at a premium. Two simplified examples of surge protection applications are illustrated below.

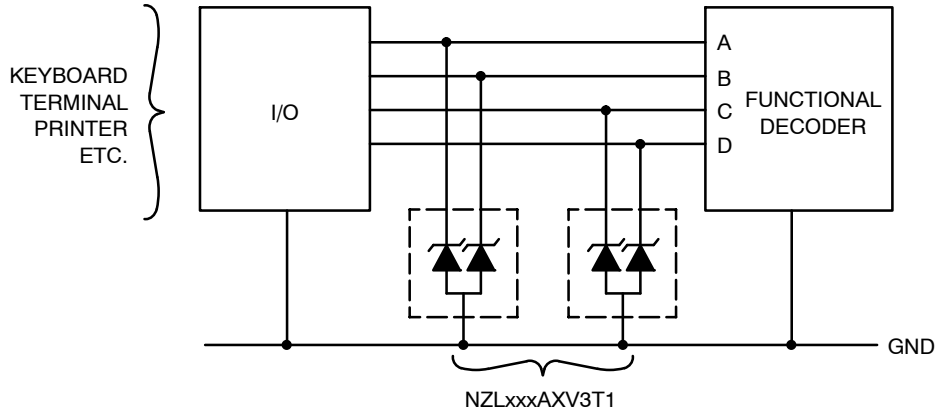

Figure 8. Computer Interface Protection

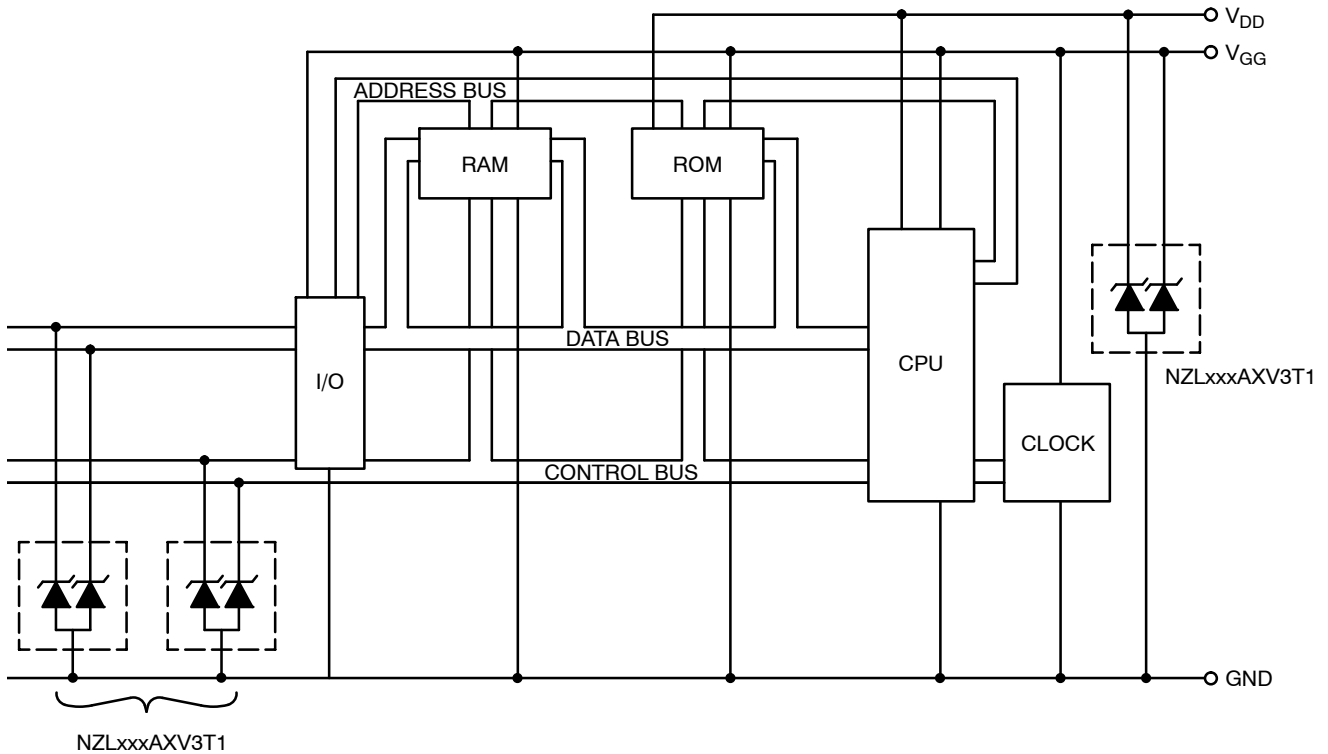

Figure 9. Microprocessor Protection

MECHANICAL CASE OUTLINE

PACKAGE DIMENSIONS

ON Semiconductor®



SC-89, 3 LEAD CASE 463C-03 ISSUE C

DATE 31 JUL 2003



SCALE 4:1

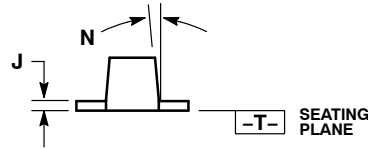
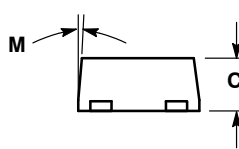
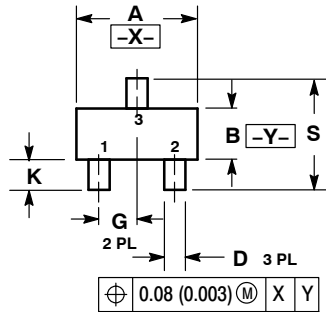

STYLE 1:
PIN 1. BASE
2. EMITTER
3. COLLECTOR

STYLE 2:
PIN 1. ANODE
2. N/C
3. CATHODE

STYLE 3:
PIN 1. ANODE
2. ANODE
3. CATHODE

STYLE 4:
PIN 1. CATHODE
2. CATHODE
3. ANODE

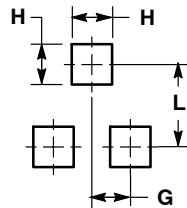

RECOMMENDED PATTERN OF SOLDER PADS

NOTES:

- DIMENSIONING AND TOLERANCING PER ANSI Y14.5M, 1982.
- CONTROLLING DIMENSION: MILLIMETERS
- MAXIMUM LEAD THICKNESS INCLUDES LEAD FINISH THICKNESS. MINIMUM LEAD THICKNESS IS THE MINIMUM THICKNESS OF BASE MATERIAL.
- 463C-01 OBSOLETE, NEW STANDARD 463C-02.

DIM	MILLIMETERS			INCHES		
	MIN	NOM	MAX	MIN	NOM	MAX
A	1.50	1.60	1.70	0.059	0.063	0.067
B	0.75	0.85	0.95	0.030	0.034	0.040
C	0.60	0.70	0.80	0.024	0.028	0.031
D	0.23	0.28	0.33	0.009	0.011	0.013
G	0.50 BSC			0.020 BSC		
H	0.53 REF			0.021 REF		
J	0.10	0.15	0.20	0.004	0.006	0.008
K	0.30	0.40	0.50	0.012	0.016	0.020
L	1.10 REF			0.043 REF		
M	---	---	10	---	---	10
N	---	---	10	---	---	10
S	1.50	1.60	1.70	0.059	0.063	0.067

GENERIC MARKING DIAGRAM*

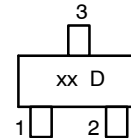

xx = Specific Device Code
D = Date Code

*This information is generic. Please refer to device data sheet for actual part marking.

DOCUMENT NUMBER:	98AON11472D	Electronic versions are uncontrolled except when accessed directly from the Document Repository. Printed versions are uncontrolled except when stamped "CONTROLLED COPY" in red.
DESCRIPTION:	SC-89, 3 LEAD	PAGE 1 OF 1

ON Semiconductor and are trademarks of Semiconductor Components Industries, LLC dba ON Semiconductor or its subsidiaries in the United States and/or other countries. ON Semiconductor reserves the right to make changes without further notice to any products herein. ON Semiconductor makes no warranty, representation or guarantee regarding the suitability of its products for any particular purpose, nor does ON Semiconductor assume any liability arising out of the application or use of any product or circuit, and specifically disclaims any and all liability, including without limitation special, consequential or incidental damages. ON Semiconductor does not convey any license under its patent rights nor the rights of others.

onsemi, **Onsemi**, and other names, marks, and brands are registered and/or common law trademarks of Semiconductor Components Industries, LLC dba "**onsemi**" or its affiliates and/or subsidiaries in the United States and/or other countries. **onsemi** owns the rights to a number of patents, trademarks, copyrights, trade secrets, and other intellectual property. A listing of **onsemi**'s product/patent coverage may be accessed at www.onsemi.com/site/pdf/Patent-Marking.pdf. **onsemi** reserves the right to make changes at any time to any products or information herein, without notice. The information herein is provided "as-is" and **onsemi** makes no warranty, representation or guarantee regarding the accuracy of the information, product features, availability, functionality, or suitability of its products for any particular purpose, nor does **onsemi** assume any liability arising out of the application or use of any product or circuit, and specifically disclaims any and all liability, including without limitation special, consequential or incidental damages. Buyer is responsible for its products and applications using **onsemi** products, including compliance with all laws, regulations and safety requirements or standards, regardless of any support or applications information provided by **onsemi**. "Typical" parameters which may be provided in **onsemi** data sheets and/or specifications can and do vary in different applications and actual performance may vary over time. All operating parameters, including "Typicals" must be validated for each customer application by customer's technical experts. **onsemi** does not convey any license under any of its intellectual property rights nor the rights of others. **onsemi** products are not designed, intended, or authorized for use as a critical component in life support systems or any FDA Class 3 medical devices or medical devices with a same or similar classification in a foreign jurisdiction or any devices intended for implantation in the human body. Should Buyer purchase or use **onsemi** products for any such unintended or unauthorized application, Buyer shall indemnify and hold **onsemi** and its officers, employees, subsidiaries, affiliates, and distributors harmless against all claims, costs, damages, and expenses, and reasonable attorney fees arising out of, directly or indirectly, any claim of personal injury or death associated with such unintended or unauthorized use, even if such claim alleges that **onsemi** was negligent regarding the design or manufacture of the part. **onsemi** is an Equal Opportunity/Affirmative Action Employer. This literature is subject to all applicable copyright laws and is not for resale in any manner.

PUBLICATION ORDERING INFORMATION

LITERATURE FULFILLMENT:

Email Requests to: orderlit@onsemi.com

onsemi Website: www.onsemi.com

TECHNICAL SUPPORT

North American Technical Support:

Voice Mail: 1 800-282-9855 Toll Free USA/Canada

Phone: 011 421 33 790 2910

Europe, Middle East and Africa Technical Support:

Phone: 00421 33 790 2910

For additional information, please contact your local Sales Representative