

FEATURES

- UL60950 recognised²
- 4:1 wide range voltage input
- Operating temperature range -40°C to 85°C
- Typical load regulation from 0.05%
- 1.5kVDC isolation 'Hi Pot Test'
- 3.3V, 5V, 12V & 15V outputs
- UL 94V-0 package materials
- No electrolytic capacitors
- Thermal shutdown
- Under voltage lock out
- Current fold back

PRODUCT OVERVIEW

The NCS12 series of DC-DC converters offers single & dual output voltages from input voltage ranges of 9-36V and 18-75V. The NCS12 is housed in an industry standard package with a standard pinout. The NCS12 is packaged in a metal case for improved EMI shielding and is also encapsulated for superior thermal performance.

Applications include telecommunications, battery powered systems, process control and distributed power systems.

SELECTION GUIDE

Order Code	Input Voltage Nom. V	Output Voltage V	Output Current A	Load Regulation			Efficiency		MTTF ¹ Hrs	Recommended Alternative		
				Positive Output	Negative Output	Positive Output	Negative Output	Min.			Typ.	
				Typical		Max						
				%	%	%	%	%	%			
Recommended In Production												
NCS12S1203C	12	3.3	3.64	1		1.5		78	83.5	269,492		
NCS12S1205C	12	5	2.40	0.5		1		84	88	313,578		
NCS12S1212C	12	12	1.00	0.1		0.3		83	84.5	230,569		
NCS12S1215C	12	15	0.80	0.1		0.3		83	85.5	195,596		
NCS12S4803C	48	3.3	3.64	1.2		2		81	85.5	341,943		
NCS12S4805C	48	5	2.40	0.5		1		84	87.5	418,117		
NCS12S4812C	48	12	1.00	0.1		0.3		82	84.5	296,593		
NCS12S4815C	48	15	0.80	0.1		0.3		84	85	259,485		
Discontinued												
NCS12D1205C	12	±5	±1.2	0.15	0.3	0.3	2	80	81.5	182,655	Contact Murata	
NCS12D1212C	12	±12	±0.5	0.05	0.2	0.3	1.5	83	85	158,750	Contact Murata	
NCS12D1215C	12	±15	±0.4	0.05	0.1	0.3	1.5	84	86	140,435	Contact Murata	
NCS12D4805C	48	±5	±1.2	0.15	0.5	0.3	2	78	80	165,931	Contact Murata	
NCS12D4812C	48	±12	±0.5	0.05	0.4	0.3	1.5	83	85	215,533	Contact Murata	
NCS12D4815C	48	±15	±0.4	0.05	0.4	0.3	1.5	83	85	146,257	Contact Murata	

SELECTION GUIDE (Continued)

Order Code	Input Current			Ripple and Noise		Recommended Alternative
	10% Load	10% Load	100% Load	Typ. mVp/p	Max mVp/p	
	Typ. 12/48V A	Typ. 24V A	Typ. 12/48V A			
Recommended In Production						
NCS12S1203C	0.15	0.1	1.2	60	125	
NCS12S1205C	0.1	0.16	1.1	50	125	
NCS12S1212C	0.1	0.06	1.2	80	125	
NCS12S1215C	0.06	0.1	1.2	100	125	
NCS12S4803C	0.05	0.08	0.3	100	125	
NCS12S4805C	0.05	0.08	0.3	90	125	
NCS12S4812C	0.03	0.06	0.3	75	125	
NCS12S4815C	0.03	0.06	0.3	90	125	
Discontinued						
NCS12D1205C	0.04	0.07	1.25	35	100	Contact Murata
NCS12D1212C	0.04	0.07	1.2	40	100	Contact Murata
NCS12D1215C	0.05	0.07	1.5	55	100	Contact Murata
NCS12D4805C	0.03	0.07	0.3	70	100	Contact Murata
NCS12D4812C	0.03	0.07	0.3	84	100	Contact Murata
NCS12D4815C	0.03	0.07	0.4	55	100	Contact Murata



1. Calculated using MIL-HDBK-217 FN2, parts stress method with nominal input voltage at full load
2. The NCS12DxxxxC variants are not recognised to UL60950

All specifications typical at TA=25°C, nominal input voltage and rated output current unless otherwise specified.

INPUT CHARACTERISTICS					
Parameter	Conditions	Min.	Typ.	Max.	Units
Voltage range	12V input types	9	24	36	V
	48V input types	18	48	75	
Under voltage lock out	Turn on threshold 12V input types		8.5		V
	Turn off threshold 12V input types		7.5		
	Turn on threshold 48V input types		16.7		
	Turn off threshold 48V input types		15.8		
Power consumption at shutdown	NCS12X12		10		mW
	NCS12X48		100		
Reflected ripple current	48V dual output types		15		mA p-p
	All other types		10		

OUTPUT CHARACTERISTICS						
Parameter	Conditions	Min.	Typ.	Max.	Units	
Rated power	All output types			12	W	
Minimal load to meet datasheet specification		10			%	
Voltage set point accuracy	Positive outputs			±2	%	
	Negative outputs			±3		
Line regulation	Low line to high line		Positive outputs	0.04	0.1	%
			Negative outputs	0.3	1	
Cross Regulation	D1205 & D4805		±4	±6.5	%	
	D1212, D1215, D4812, D4815		±2	±5		
Transient response	Peak deviation (12.5-37.5% & 37.5-12.5% swing)			5	%V _{out}	
	Settling time (within 1% V _{out} Nom.)	Single output types	500		µs	
		Dual output types	250			

ISOLATION CHARACTERISTICS					
Parameter	Conditions	Min.	Typ.	Max.	Units
Isolation test voltage	Flash tested for 1 seconds	1500			VDC
Resistance	Viso = 1kVDC	1			GΩ
Capacitance	S1203, S1205, S4803, S4805		600		pF
	All other types		230		

GENERAL CHARACTERISTICS ¹					
Parameter	Conditions	Min.	Typ.	Max.	Units
Switching frequency	S1203, S1205, S4803 & S4805		340		kHz
	All other types		220		
Control pin input	Module on, pin unconnected or open collector floating				V
	Module off			0.8	

TEMPERATURE CHARACTERISTICS					
Parameter	Conditions	Min.	Typ.	Max.	Units
Operation	With derating - see derating graph	-40		85	°C
Storage		-50		125	
Case temperature above ambient	100% Load, Nom V _{IN} , Still Air	NCS12S1203C		65	
		NCS12S1215C, NCS12D1205C, NCS12D4805C		60	
		All other types		44	
Thermal shutdown	Case Temperature	Single 3.3V & 5V outputs		135	
		All other types		120	

ABSOLUTE MAXIMUM RATINGS

Short-circuit protection (for SELV input voltages)	30 minutes
Control pin input voltage	18V Max
Lead temperature 1.0mm from case for 10 seconds (to JEDEC JESD22-B106 ISS C)	260°C
Wave Solder	Wave Solder profile not to exceed the profile recommended in IEC 61760-1 Section 6.1.3. Please refer to application notes for further information.
Input voltage, NCS12 12V input types	40V
Input voltage, NCS12 48V input types	80V

TECHNICAL NOTES

ISOLATION VOLTAGE

'Hi Pot Test', 'Flash Tested', 'Withstand Voltage', 'Proof Voltage', 'Dielectric Withstand Voltage' & 'Isolation Test Voltage' are all terms that relate to the same thing, a test voltage, applied for a specified time, across a component designed to provide electrical isolation, to verify the integrity of that isolation.

Murata Power Solutions NCS12 series of DC-DC converters are all 100% production tested at their stated isolation voltage. This is 1.5kVDC for 1 second.

A question commonly asked is, "What is the continuous voltage that can be applied across the part in normal operation?"

For a part holding no specific agency approvals, such as the NCS12 series, both input and output should normally be maintained within SELV limits i.e. less than 42.4V peak, or 60VDC. The isolation test voltage represents a measure of immunity to transient voltages and the part should never be used as an element of a safety isolation system. The part could be expected to function correctly with several hundred volts offset applied continuously across the isolation barrier; but then the circuitry on both sides of the barrier must be regarded as operating at an unsafe voltage and further isolation/insulation systems must form a barrier between these circuits and any user-accessible circuitry according to safety standard requirements.

REPEATED HIGH-VOLTAGE ISOLATION TESTING

It is well known that repeated high-voltage isolation testing of a barrier component can actually degrade isolation capability, to a lesser or greater degree depending on materials, construction and environment. The NCS12 series has an ER ferrite core, with no additional insulation between primary and secondary windings of enamelled wire. While parts can be expected to withstand several times the stated test voltage, the isolation capability does depend on the wire insulation. Any material, including this enamel (typically polyurethane) is susceptible to eventual chemical degradation when subject to very high applied voltages thus implying that the number of tests should be strictly limited. We therefore strongly advise against repeated high voltage isolation testing, but if it is absolutely required, that the voltage be reduced by 20% from specified test voltage.

This consideration equally applies to agency recognised parts rated for better than functional isolation where the wire enamel insulation is always supplemented by a further insulation system of physical spacing or barriers.

SAFETY APPROVAL

UL60950

The NCS12 series is recognised by Underwriters Laboratory (UL) to UL60950 for functional insulation to a working voltage of 43Vrms. The NCS12DxxxxC variants are not recognised to UL60950.

File number E151252 applies.

Fusing

The NCS12 Series of converters are not internally fused so to meet the requirements of UL an anti-surge input line fuse should always be used with ratings as defined below.

NCS12S12xxC: 4A

NCS12S48xxC: 2A

All fuses should be UL recognised and rated to 125V.

RoHS COMPLIANCE INFORMATION



This series is compatible with RoHS soldering systems with a peak wave solder temperature of 260°C for 10 seconds. Please refer to [application notes](#) for further information. The pin termination finish on this product series is a Gold flash (0.05-0.10 micron) over Nickel Preplate. The series is backward compatible with Sn/Pb soldering systems. For further information, please visit www.murata-ps.com/rohs

ENVIRONMENTAL VALIDATION TESTING

The following tests have been conducted on this product series, as part of our design verification process. The datasheet characteristics specify user operating conditions for this series, please contact Murata if further information about the tests is required.

Test	Standard	Condition
Temperature cycling	MIL-STD-883 Method 1010, Condition B	10 cycles between two chambers set to achieve -55°C and +125°C. The dwell time shall not be less than 10min and the load shall reach the specified temperature in 15min.
Storage life	JEDEC JESD22-A103, Condition A	125°C +10/-0°C for ≥1000 hours.
Vibration	MIL-STD-883 Method 2007, Condition A	1.5mm pk-pk/20g pk min, 20-2000Hz, 4 sweeps in each of 3 mutually perpendicular axes at 3 oct/min.
Shock	MIL-STD-883 Method 2002, Condition A	500g 1ms half sine, 5 shocks in each direction of 3 mutually perpendicular axes.
Bump	IEC Class 4M5 of ETS 300 019-2-4	Shock Spectrum Type II, 6ms duration, 250m/s ² 500 bumps in 6 directions.
Solder heat	JEDEC JESD22-B106	The test sample is subjected to a molten solder bath at 260 ±5°C for 10 seconds (96SC tin/silver/copper). The leads are dipped in the solder bath to within 1mm of the device body.
Solderability	IPC/ECA J-STD-002, Test A and A1	SnPb (Test A) For leaded solderability the parts are conditioned in a steam ager for 8 hours ±15 min. at a temperature of 93±3°C. Dipped in solder at 245°C ±5°C for 5 +0/-0.5 seconds. Pb-free (Test A1) For lead free solderability the parts are conditioned in a steam ager for 8 hours ± 15 min. at a temperature of 93±3°C. Dipped in solder at 255°C ±5°C for 5 +0/-0.5 seconds.
Solvent cleaning	Resistance to cleaning agents	Solvent – Novec 71IPA & Topklean EL-20A. Pulsed ultrasonic immersion 45°C-65°C.
Solvent resistance	MIL-STD-883 Method 2015	The parts and the bristle portion of the brush are immersed in Isopropanol for a minimum of 1 minute. The parts are brushed 3 times, after the third time the parts are blown dry and inspected.
Lead Integrity (Adhesion)	MIL-STD-883 Method 2025	Leads are bent through 90° until a fracture occurs.
Lead Integrity (Fatigue)	MIL-STD-883 Method 2004, Condition B ₂	The leads are bent to an angle of 15°. Each lead is subjected to 3 cycles.
Lead Integrity (Tension/Pull)	MIL-STD-883 Method 2004, Condition A ₁	Pull of 0.227kg applied for 30 seconds. The force is then increased until the pins snap.

PART NUMBER STRUCTURE

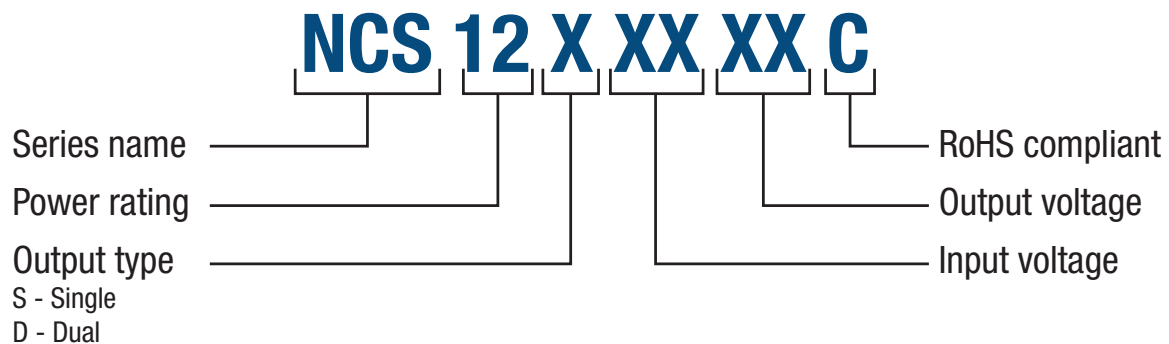

CHARACTERISATION TEST METHODS

Ripple & Noise Characterisation Method

Ripple and noise measurements are performed with the following test configuration.

C1	1 μ F X7R multilayer ceramic capacitor, voltage rating to be a minimum of 3 times the output voltage of the DC-DC converter
C2	10 μ F tantalum capacitor, voltage rating to be a minimum of 1.5 times the output voltage of the DC-DC converter with an ESR of less than 100m Ω at 100 kHz
C3	100nF multilayer ceramic capacitor, general purpose
R1	450 Ω resistor, carbon film, \pm 1% tolerance
R2	50 Ω BNC termination
T1	3T of the coax cable through a ferrite toroid
RLOAD	Resistive load to the maximum power rating of the DC-DC converter. Connections should be made via twisted wires

Measured values are multiplied by 10 to obtain the specified values.

Differential Mode Noise Test Schematic

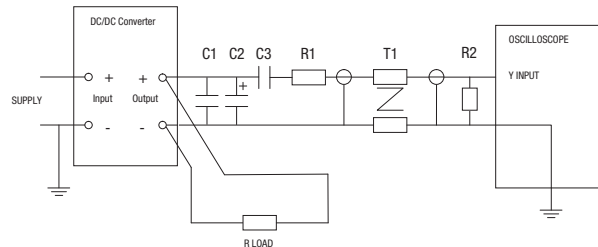

APPLICATION NOTES

Output Capacitance and start-up times

The NCS12 series does not require output capacitors to meet datasheet specification. To meet datasheet specification, total output capacitance should not exceed:

Part No.	Maximum Load Capacitance (per output)	Start-up times
	μ F	ms
NCS12S1203C	470	16
NCS12S1205C	470	22
NCS12S1212C	220	7
NCS12S1215C	220	8.5
NCS12S4803C	470	14
NCS12S4805C	470	22
NCS12S4812C	220	8
NCS12S4815C	220	8.5
NCS12D1205C	220	5
NCS12D1212C	100	8
NCS12D1215C	100	9
NCS12D4805C	220	5
NCS12D4812C	100	7.5
NCS12D4815C	100	7

EFFICIENCY VS LOAD

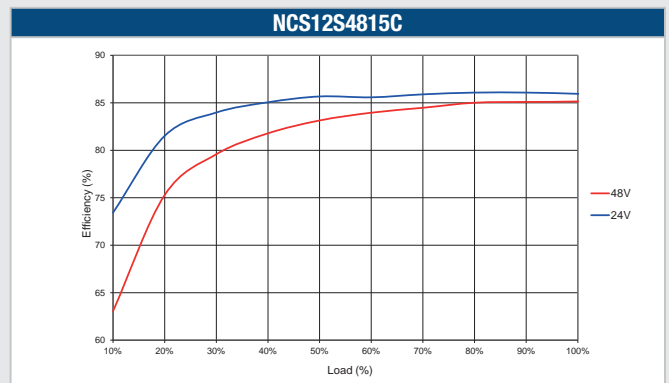
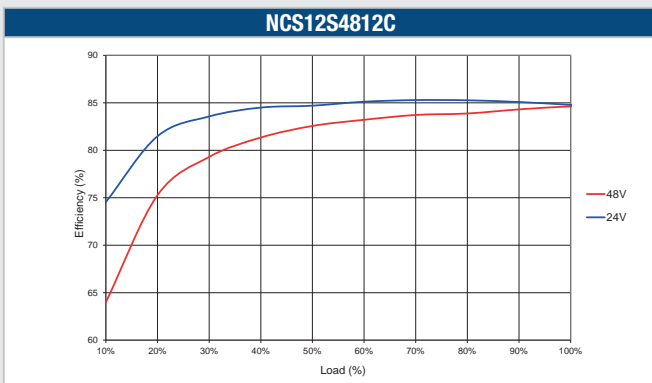
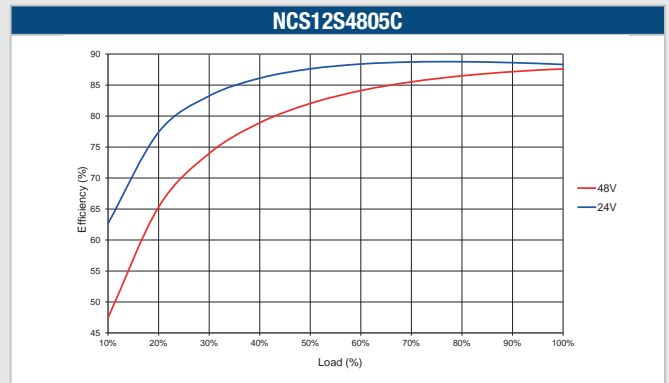
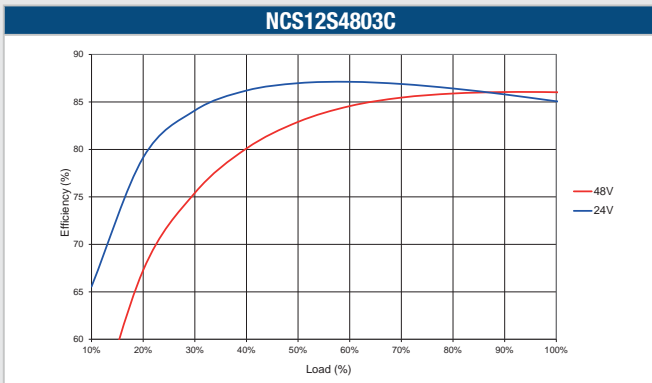
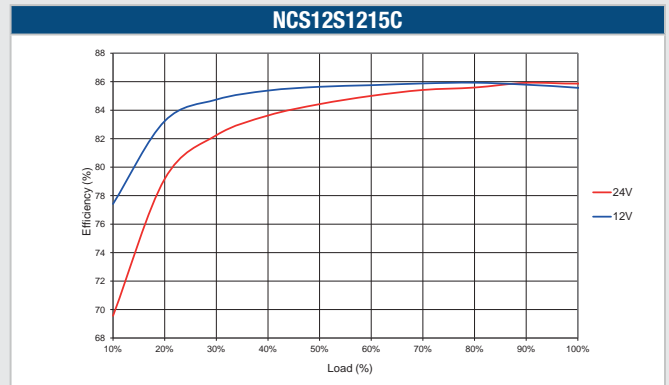
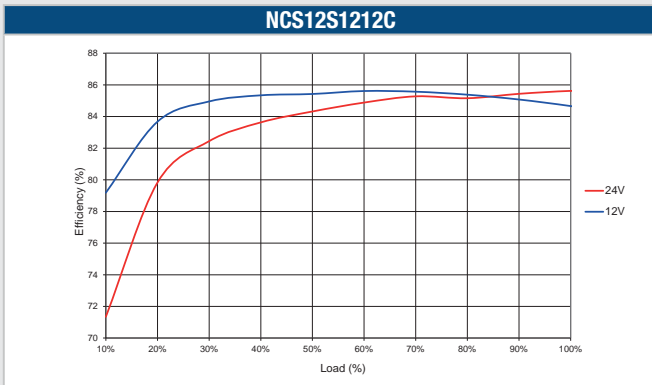
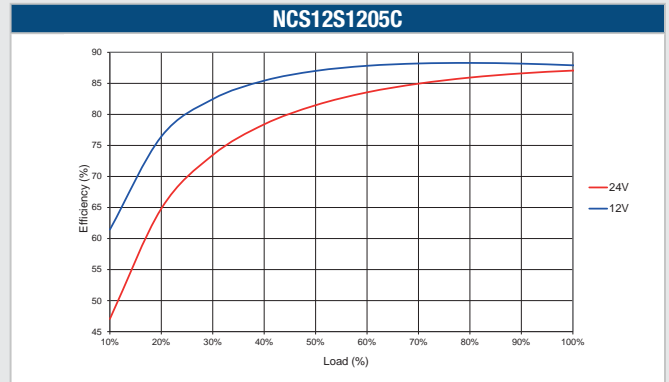
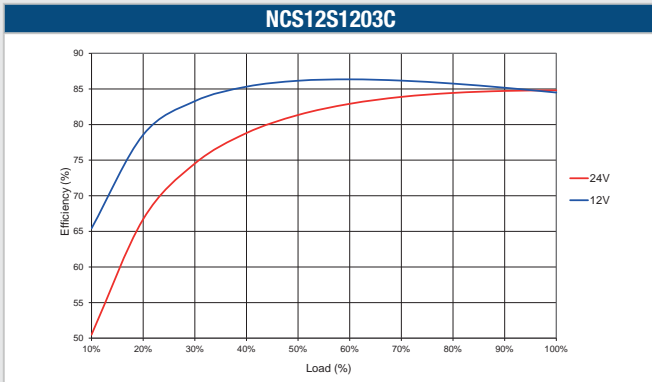

EFFICIENCY VS LOAD (Continued)

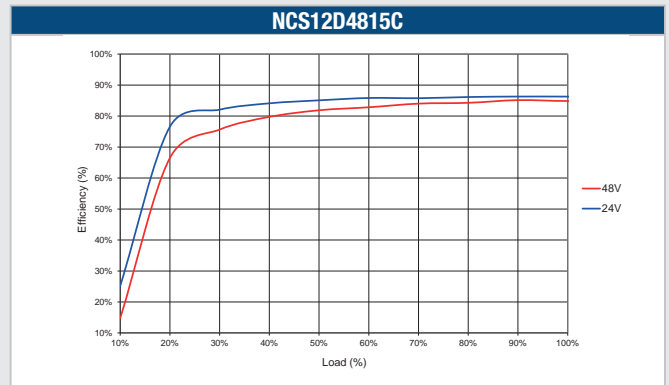
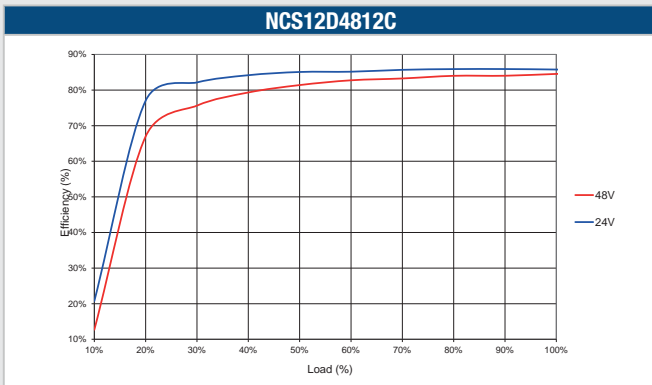
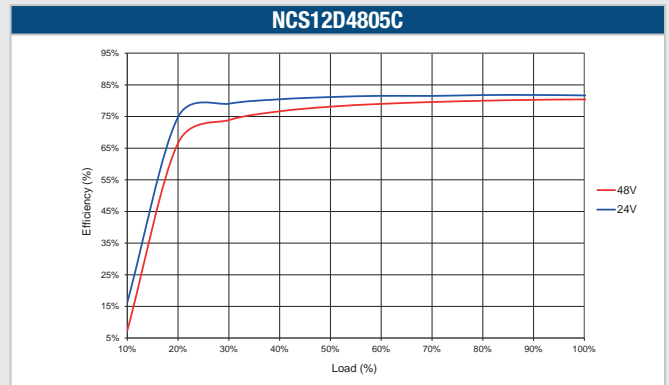
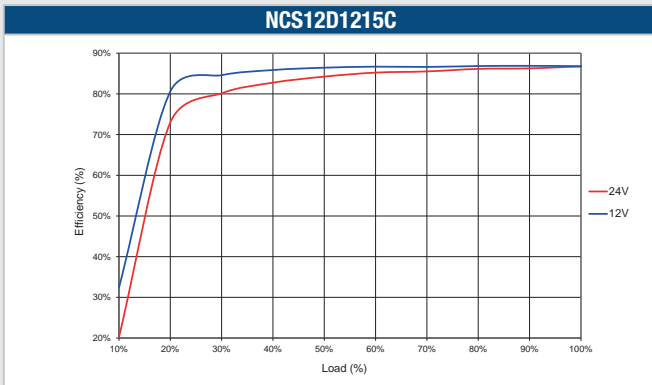
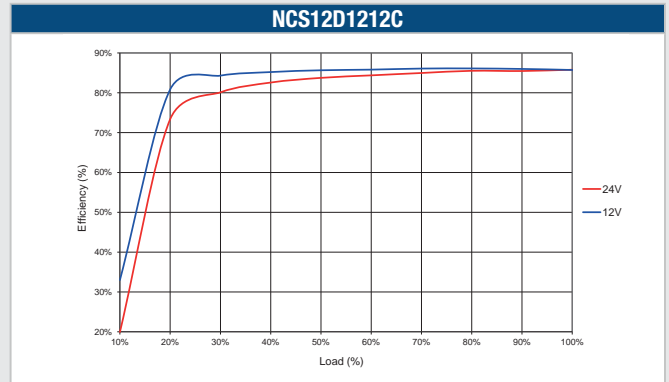
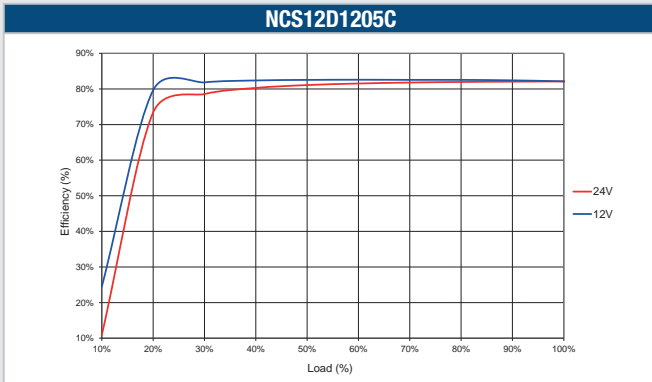

TEMPERATURE DERATING

NCS12S1203C

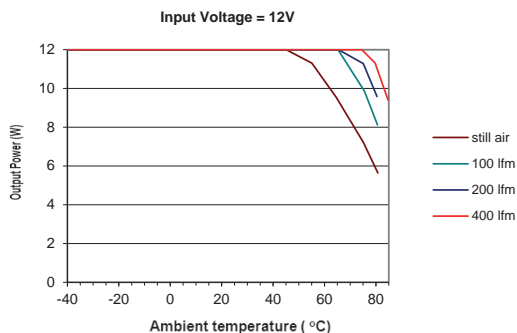
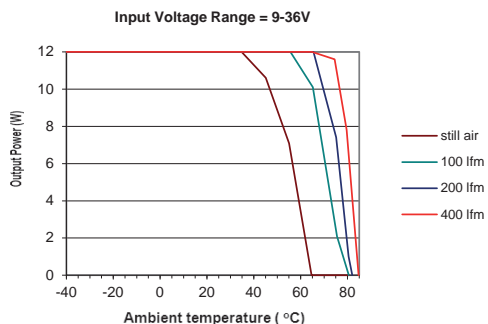

NCS12S1205C

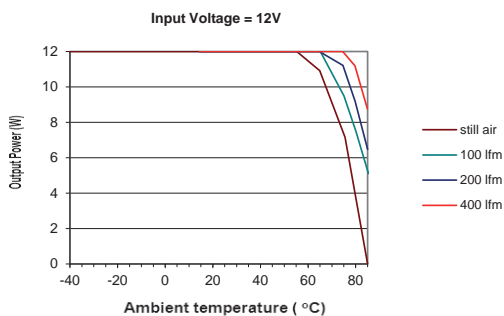
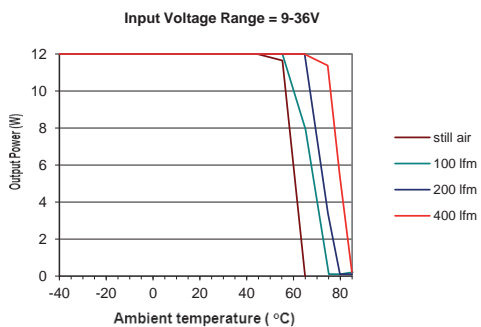

NCS12S1212C

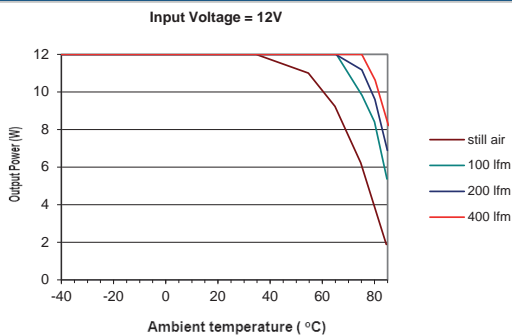
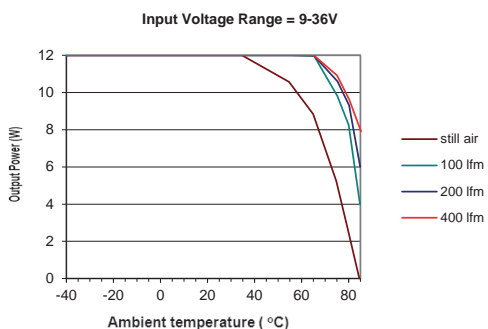

NCS12S1215C

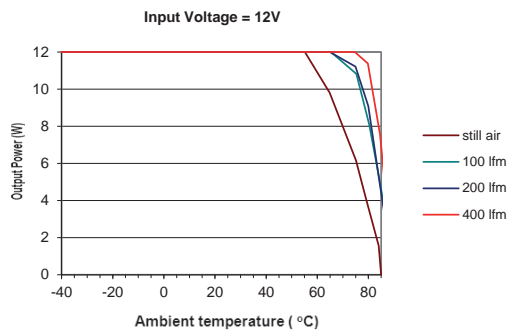
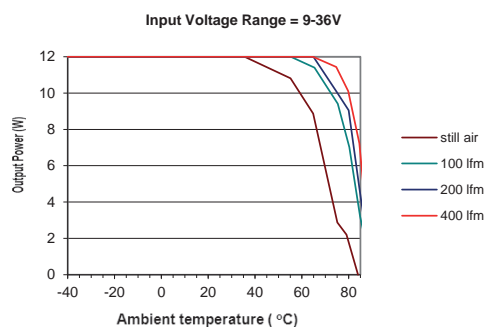

TEMPERATURE DERATING (Continued)

NCS12S4803C

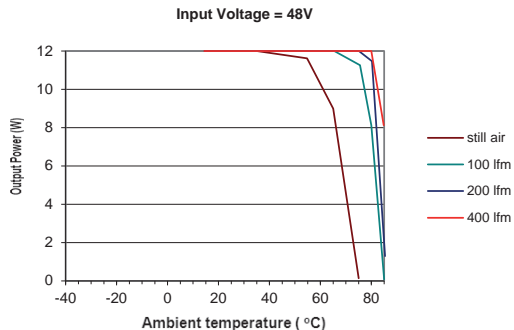
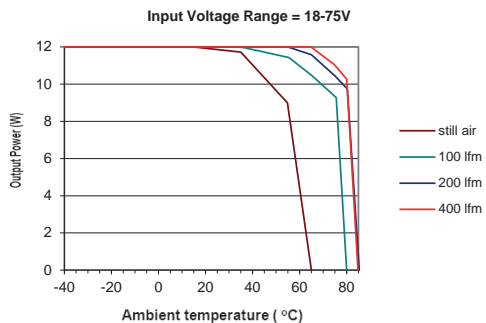

NCS12S4805C

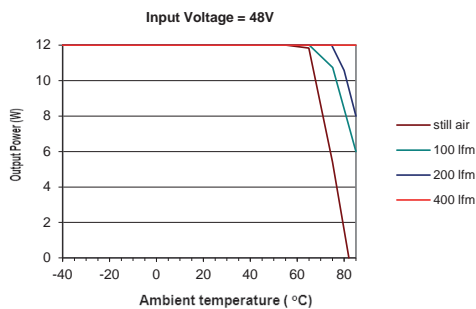
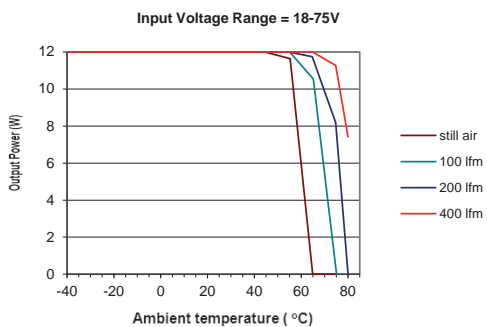

NCS12S4812C

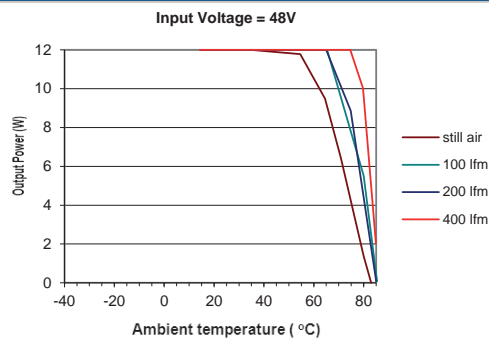
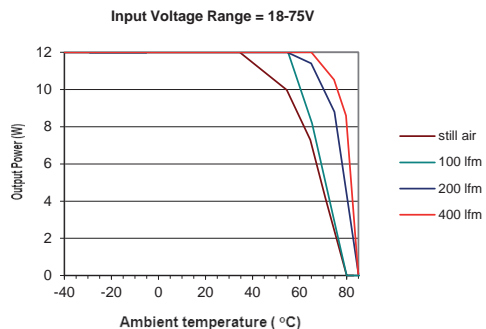

NCS12S4815C

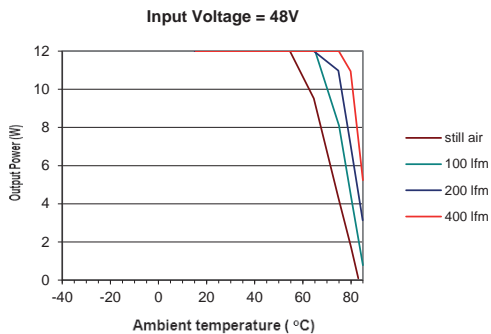
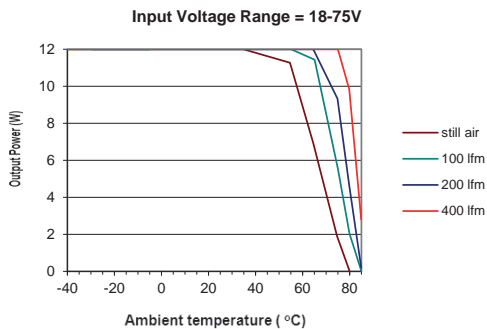

TEMPERATURE DERATING (Continued)

NCS12D1205C

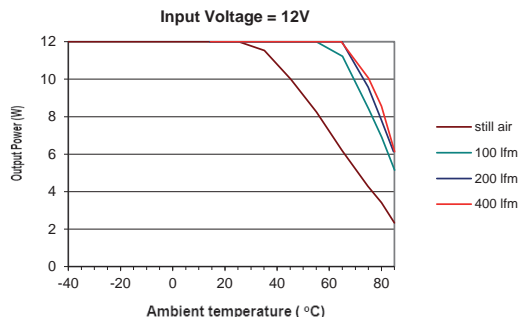
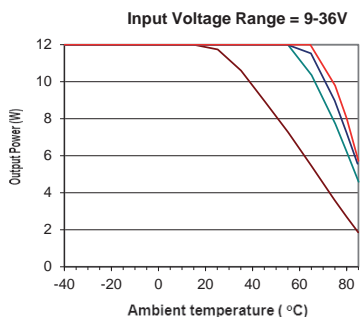

NCS12D1212C

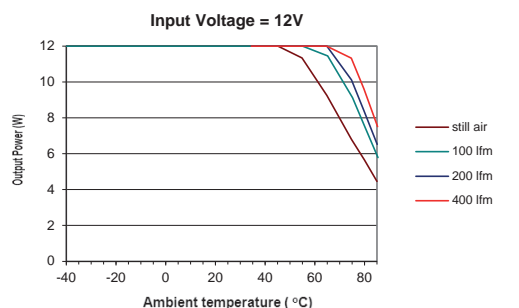
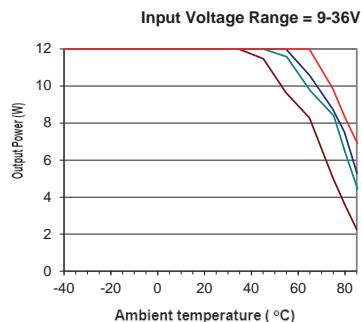

NCS12D1215C

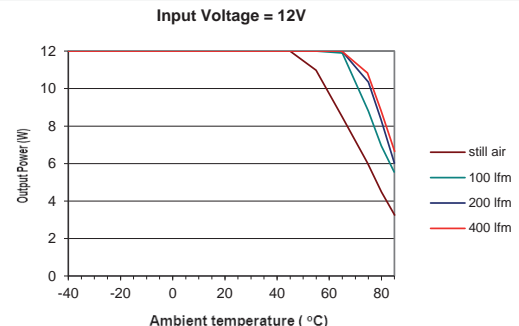
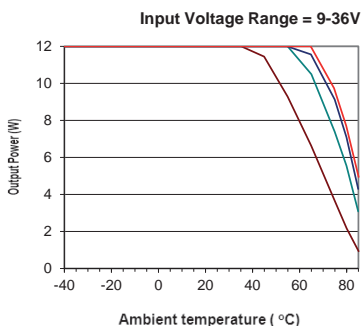

NCS12D4805C

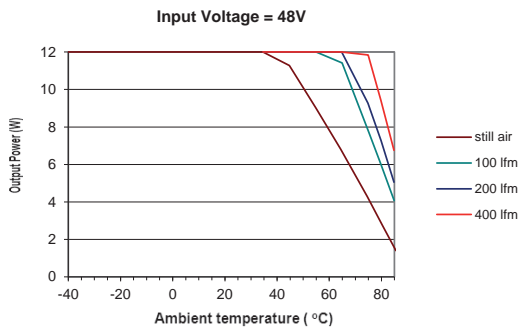
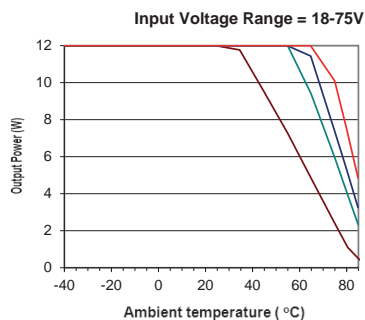

TEMPERATURE DERATING (Continued)

NCS12D4812C

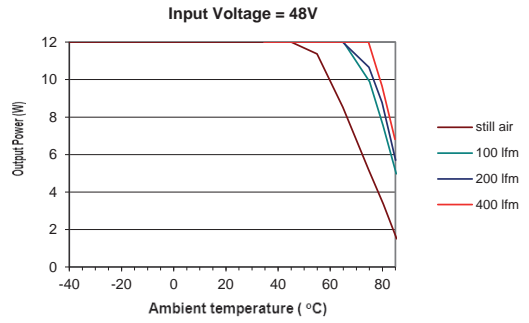
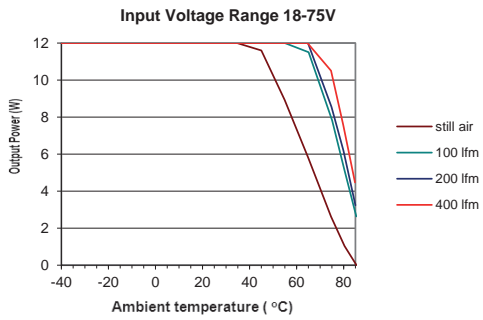

NCS12D4815C

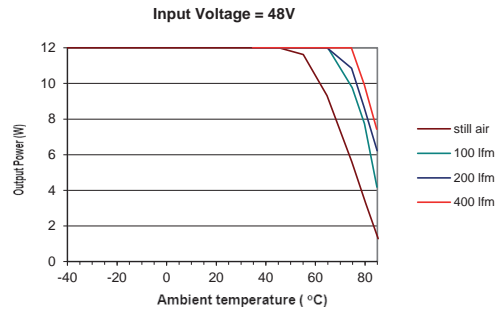
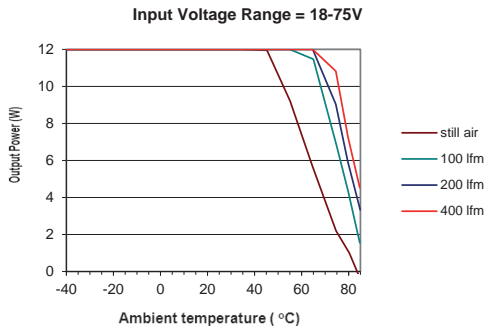

EMC FILTERING AND SPECTRA

FILTERING

The module includes a basic level of filtering, sufficient for many applications. Where lower noise levels are desired, filters can easily be added to achieve any required noise performance.

A DC-DC converter generates noise in two principle forms: that which is radiated from its body and that conducted on its external connections. There are three separate modes of conducted noise: input differential, output differential and input-output.

This last appears as common mode at the input and the output, and cannot therefore be removed by filtering at the input or output alone. The first level of filtering is to connect capacitors between input and output returns, to reduce this form of noise. It typically contains high harmonics of the switching frequency, which tend to appear as spikes on surrounding circuits. The voltage rating of this capacitor must match the required isolation voltage. (Due to the great variety in isolation voltage and required noise performance, this capacitor has not been included within the converter.)

Input ripple is a voltage developed across the internal Input decoupling capacitor. It is therefore measured with a defined supply source impedance. Although simple series inductance will provide filtering, on its own it can degrade the stability. A shunt capacitor is therefore recommended across the converter input terminals, so that it is fed from a low impedance.

If no filtering is required, the inductance of long supply wiring could also cause a problem, requiring an input decoupling capacitor for stability. An electrolytic will perform well in these situations. The input-output filtering is performed by the common-mode choke on the primary. This could be placed on the output, but would then degrade the regulation and produce less benefit for a given size, cost, and power loss.

Radiated noise is present in magnetic and electrostatic forms. The latter is suppressed by the metal case, which is connected to the output return, typically a zero-volt point. Thanks to the small size of these units, neither form of noise will be radiated "efficiently", so will not normally cause a problem. Any question of this kind usually better repays attention to conducted signals.

EMC FILTER AND VALUES TO OBTAIN SPECTRA AS SHOWN

The following filter circuit shows the input filter typically required to meet CISPR22 Quasi-Peak Curve B.

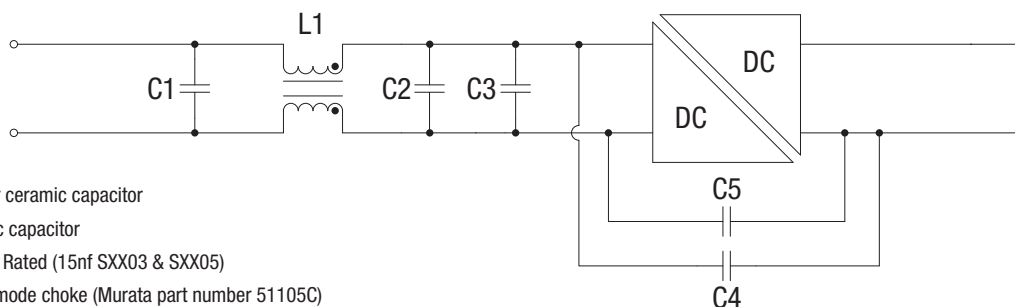

- C1, C2** 1µF Polyester or ceramic capacitor
- C3** 47µF Electrolytic capacitor
- C4 & C5** 10nF 250 VAC Y Rated (15nf SXX03 & SXX05)
- L1** 1mH Common-mode choke (Murata part number 51105C)

EMC FILTERING AND SPECTRA (Continued)

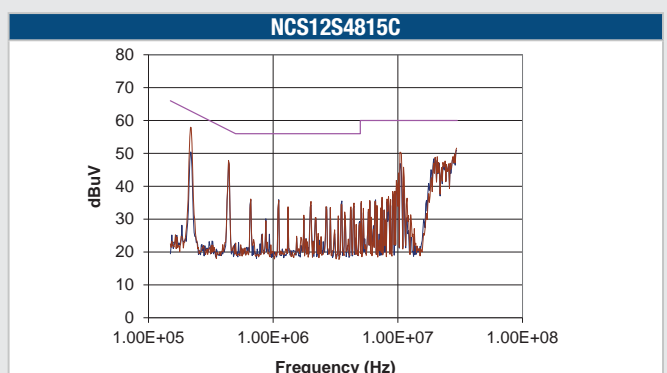
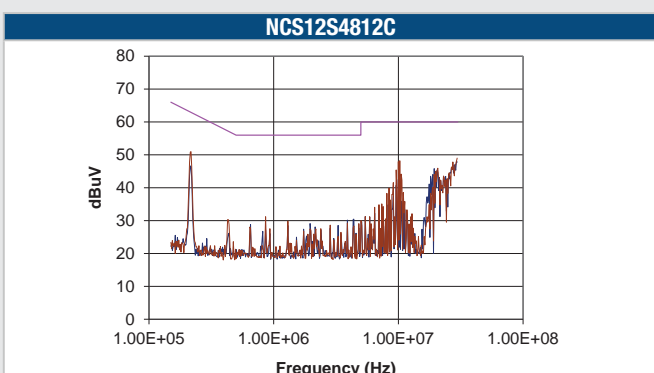
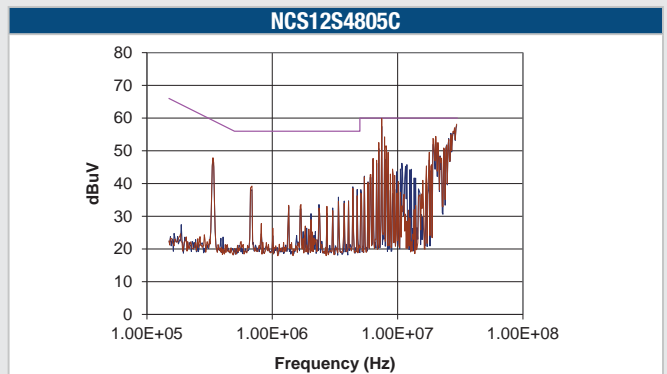
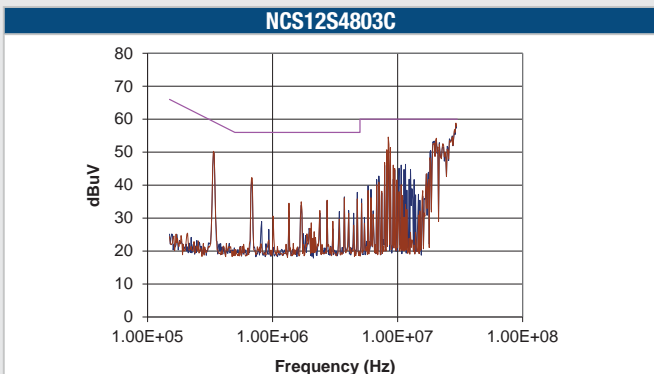
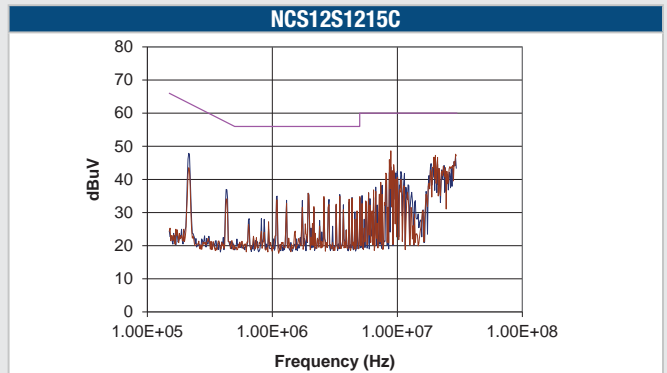
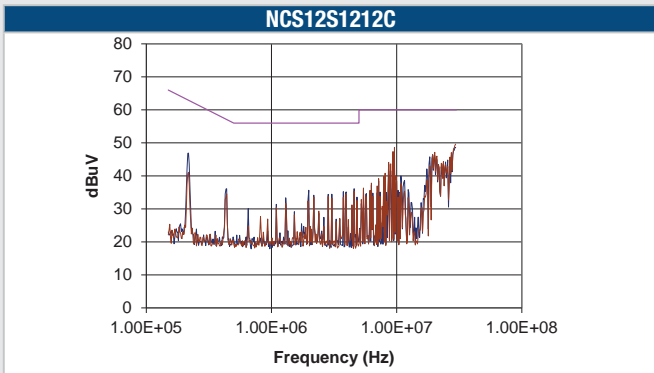
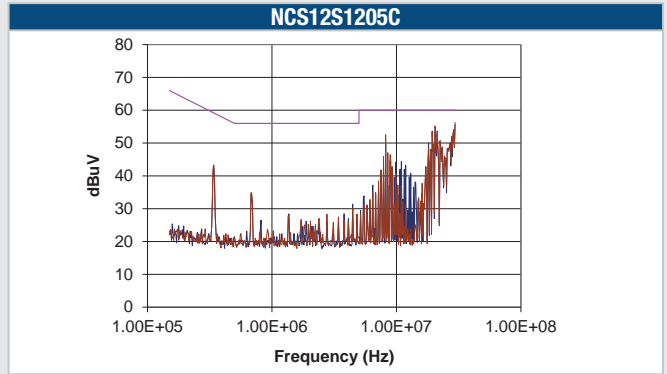
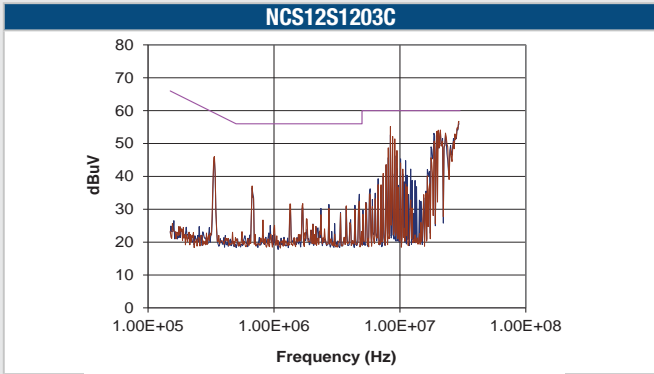

EMC FILTERING AND SPECTRA (Continued)

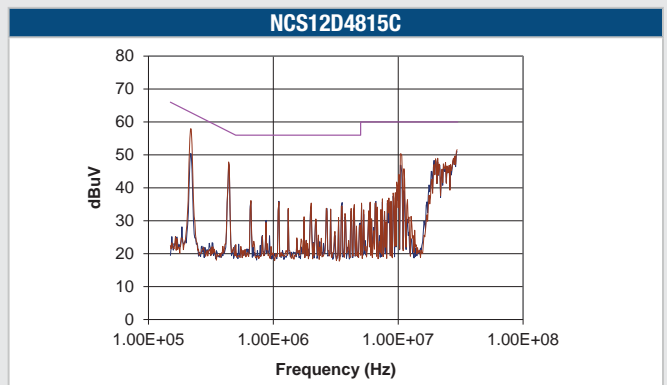
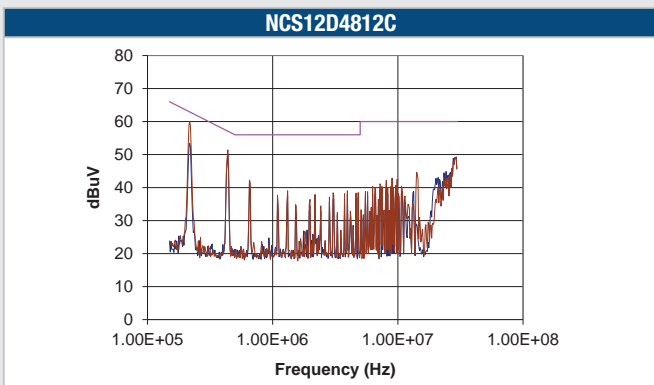
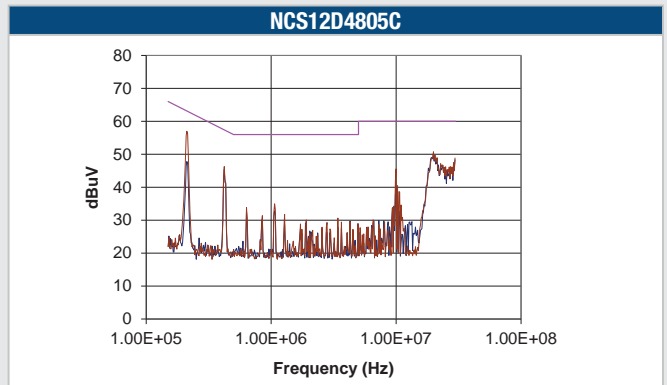
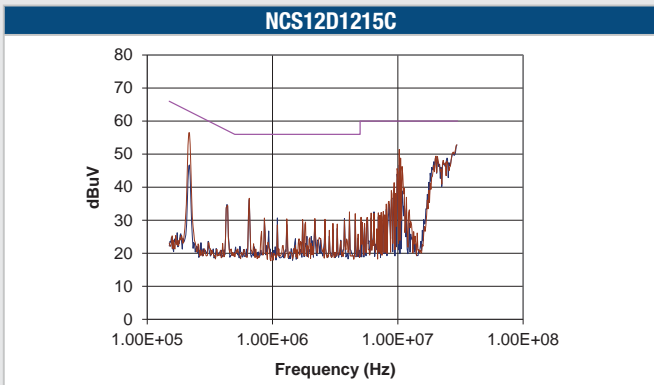
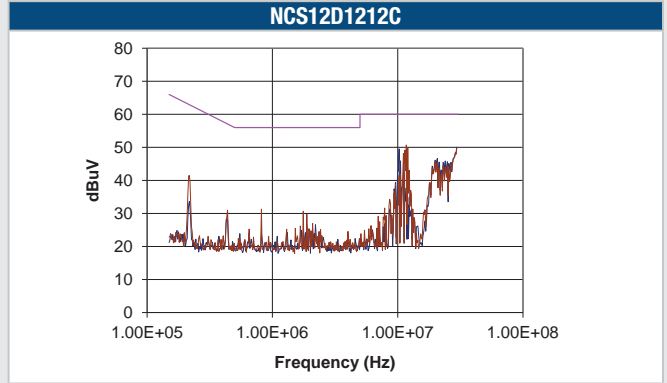
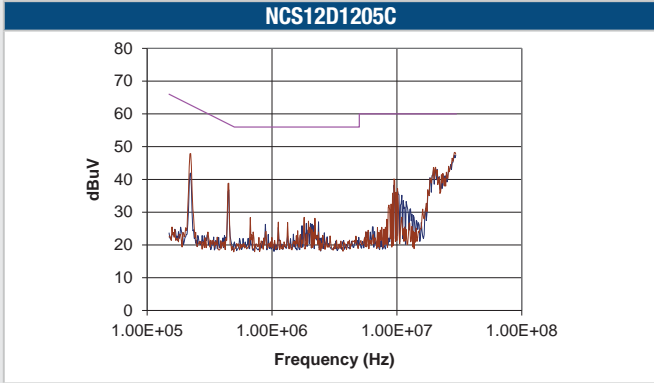

PACKAGE SPECIFICATIONS

MECHANICAL DIMENSIONS - SINGLE

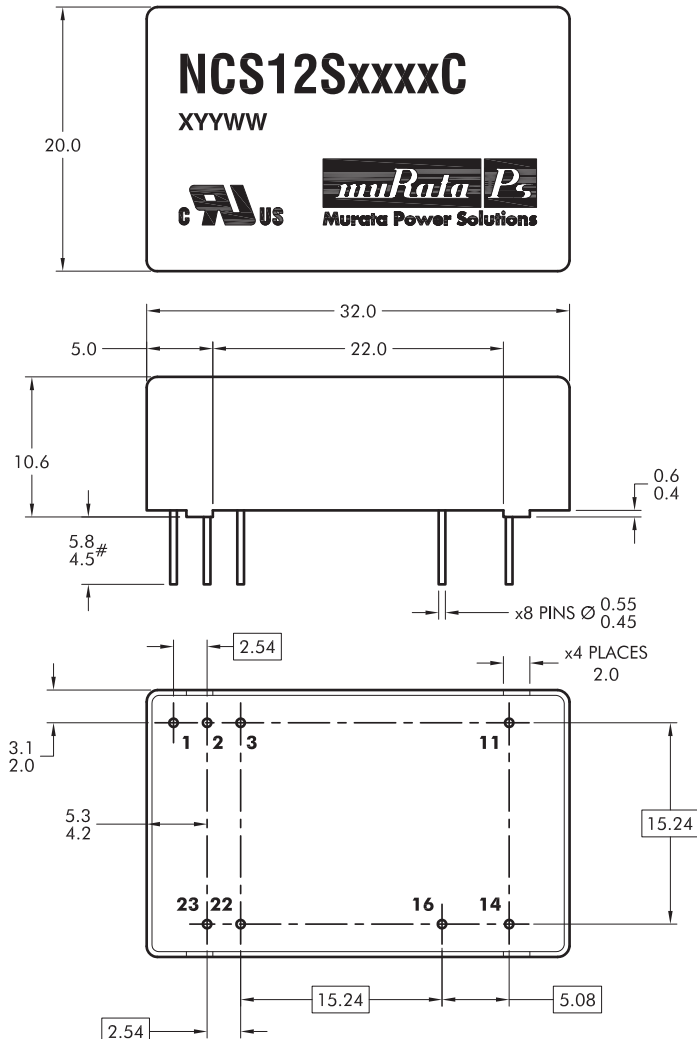

The pin length of the following variants is 4.2-5.3; NCS12Sxx03C & NCS12Sxx05SC

All dimensions in mm.
Tolerances (unless otherwise stated) ±0.4.
All pins on a 2.54 pitch and within ±0.25 of true position

Weight: 17g

PIN CONNECTIONS

Pin	Function
	Single
1	Control
2	-VIN
3	-VIN
9	No pin
11	N/C
14	+VOUT
16	0V
22	+VIN
23	+VIN

TUBE OUTLINE DIMENSIONS

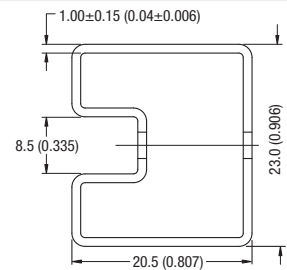

Tube length 520 (20.47)

All dimensions in mm (inches) ±0.25 (0.010).

Quantity: 15

RECOMMENDED FOOTPRINT DETAILS

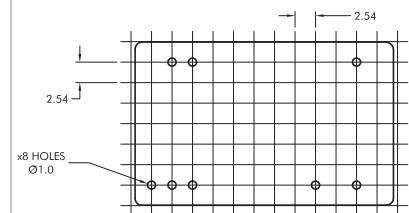

DISCLAIMER

Unless otherwise stated in the datasheet, all products are designed for standard commercial and industrial applications and NOT for safety-critical and/or life-critical applications.

Particularly for safety-critical and/or life-critical applications, i.e. applications that may directly endanger or cause the loss of life, inflict bodily harm and/or loss or severe damage to equipment/property, and severely harm the environment, a prior explicit written approval from Murata is strictly required. Any use of Murata standard products for any safety-critical, life-critical or any related applications without any prior explicit written approval from Murata shall be deemed unauthorised use.

These applications include but are not limited to:

- Aircraft equipment
- Aerospace equipment
- Undersea equipment
- Power plant control equipment
- Medical equipment
- Transportation equipment (automobiles, trains, ships, etc.)
- Traffic signal equipment
- Disaster prevention / crime prevention equipment
- Data Processing equipment

Murata makes no express or implied warranty, representation, or guarantee of suitability, fitness for any particular use/purpose and/or compatibility with any application or device of the buyer, nor does Murata assume any liability whatsoever arising out of unauthorised use of any Murata product for the application of the buyer. The suitability, fitness for any particular use/purpose and/or compatibility of Murata product with any application or device of the buyer remain to be the responsibility and liability of the buyer.

Buyer represents and agrees that it has all the necessary expertise to create and implement safeguards that anticipate dangerous consequences of failures, monitor failures and their consequences, lessen the likelihood of failures that might cause harm, and take appropriate remedial actions. Buyer will fully indemnify and hold Murata, its affiliated companies, and its representatives harmless against any damages arising out of unauthorised use of any Murata products in any safety-critical and/or life-critical applications.

Remark: Murata in this section refers to Murata Manufacturing Company and its affiliated companies worldwide including, but not limited to, Murata Power Solutions.



This product is subject to the following [operating requirements](https://www.murata.com/en-eu/products/power/requirements) and the [Life and Safety Critical Application Sales Policy](https://www.murata.com/en-eu/products/power/requirements):

Refer to: <https://www.murata.com/en-eu/products/power/requirements>

Murata Power Solutions (Milton Keynes) Ltd. makes no representation that the use of its products in the circuits described herein, or the use of other technical information contained herein, will not infringe upon existing or future patent rights. The descriptions contained herein do not imply the granting of licenses to make, use, or sell equipment constructed in accordance therewith. Specifications are subject to change without notice.

© 2022 Murata Power Solutions (Milton Keynes) Ltd.