

# High performance dual-stage IEC C14 and C20 inlet filter



- Rated currents up to 20 A
- Excellent performance/size ratio
- IEC C14 or C20 inlet acc. IEC 60320-1
- Medical versions (B type) acc. to IEC/EN 60601-1
- Snap-in and rear mount versions (S and M type)
- Earth line choke version (Refer to FN9255E)
- Safe voltage discharge version (R-type)



### Performance indicators

Attenuation performance



Rated current [A]

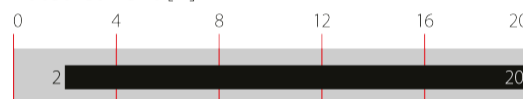

### Approvals & Compliances



The FN9255 IEC inlet filter incorporates a dual stage filter into an IEC inlet that offers excellent filter attenuation in a compact housing. Using an IEC inlet, at the point of entry offers an optimized position and practical solution for integrating an EMC filter into any system. A wide selection of current ratings, output connections and mounting possibilities are available. The filter family also offers options that comply to medical application requirements and the entire family complies to all necessary safety approvals.

### Features and Benefits

- Exceptional attenuation performance from 150kHz to 300MHz due to dual-stage design
- High saturation resistance and excellent thermal behavior
- Rear and Front flange or snap-in mounting options
- FN 9255 B versions comply with the requirements of 1MOP acc. to IEC/EN 60601-1 for creepage and clearance, leakage current and high potential testing
- Optional earth line choke see FN 9255 E versions
- All versions according IEC/EN 62368-1

## Technical Specifications



<b>Maximum continuous operating voltage</b>	250 VAC, 50/60 Hz
<b>Rated currents</b>	2 to 20 A @ 40°C max
<b>Operating frequency</b>	DC to 400 Hz
<b>Approvals by rated current</b>	ENEC and CQC: IEC C14 Inlet - 2 to 10 A ENEC and CQC: IEC C20 Inlet - 16 A UL: IEC C14 Inlet - 2 to 15A UL: IEC C20 Inlet - 16 to 20A
<b>High potential test voltage</b>	P → PE 2000 VAC for 2 sec (standard types) P → PE 2500 VAC for 2 sec (B types) P → N 760 VAC for 2 sec
<b>Protection category</b>	IP 40 according to IEC 60529
<b>Temperature range (operation and storage)</b>	-25°C to +85°C (25/85/21)
<b>Design corresponding to</b>	UL 60939-3, CSA Std C22.2 No. 8, IEC/EN 60939-3, GB/T 15287, GB/T 15288
<b>Surge pulse protection (Z type)</b>	Helps compliance to IEC61000-4-5 (Differential Mode only)
<b>Flammability according to</b>	UL 94 V-0
<b>MTBF @ Rated amb. Temp./Voltage (Mil-HB-217F)</b>	> 1,000,000 hours

### Typical Applications

- Medical devices (MDD)
- In-vitro diagnostic medical devices (IVDD)
- Computing & accessories
- LCD and OLED Displays
- Test and measurement equipment
- Household and similar products as per IEC/EN55014
- Portable electrical and electronic equipment
- Small to medium-sized machines
- Single-phase power supplies, switch-mode power supplies (SMPS)

For electrical schematic refer to page 3

### Filter Selection Table

Filter	Rated current @ 40°C	Leakage current* @ 250 VAC/50 Hz (@ 120 VAC/60 Hz)	Inductance		Capacitance			Resistor R	Input connections	Output connections		Weight
			L1	L2	Cx	Cy1	Cy2			**	**	
-	-	-	-	-	-	-	-	-	-	-	-	
-	[A]	[mA]	[mH]	[μH]	[μF]	[nF]	[nF]	[kΩ]				[g]
FN 9255 x-2-..	2	0.45 (0.26)	4.8	18	0.1	2.2	1	-	C14	-06	-07	52
FN 9255 x-4-..	4	0.45 (0.26)	2.1	18	0.1	2.2	1	-	C14	-06	-07	52
FN 9255 x-6-..	6	0.45 (0.26)	0.9	18	0.1	2.2	1	-	C14	-06	-07	52
FN 9255 x-10-..	10	0.45 (0.26)	0.2	18	0.1	2.2	1	-	C14	-06	-07	54
FN 9255 x-15-..	15	0.45 (0.26)	0.13	8	0.1	2.2	1	-	C14	-06	-07	54
FN 9255 x-16-..	16	0.45 (0.26)	0.3	0.7	0.1	2.2	1	-	C20	-06	-07	130
FN 9255 x-20-..	20	0.45 (0.26)	0.3	0.7	0.1	2.2	1	-	C20	-06	-07	130
FN 9255 xB-2-..	2	-	4.8	18	0.1	-	-	1000	C14	-06	-07	52
FN 9255 xB-4-..	4	-	2.1	18	0.1	-	-	1000	C14	-06	-07	52
FN 9255 xB-6-..	6	-	0.9	18	0.1	-	-	1000	C14	-06	-07	52
FN 9255 xB-10-..	10	-	0.2	18	0.1	-	-	1000	C14	-06	-07	54
FN 9255 xB-15-..	15	-	0.13	8	0.1	-	-	1000	C14	-06	-07	54
FN 9255 xB-16-..	16	-	0.3	0.7	0.1	-	-	1000	C20	-06	-07	130
FN 9255 xB-20-..	20	-	0.3	0.7	0.1	-	-	1000	C20	-06	-07	130
FN 9255 xR-2-..	2	0.45 (0.26)	4.8	18	0.1	-	-	1000	C14	-06	-07	52
FN 9255 xR-4-..	4	0.45 (0.26)	2.1	18	0.1	-	-	1000	C14	-06	-07	52
FN 9255 xR-6-..	6	0.45 (0.26)	0.9	18	0.1	-	-	1000	C14	-06	-07	52
FN 9255 xR-10-..	10	0.45 (0.26)	0.2	18	0.1	-	-	1000	C14	-06	-07	54
FN 9255 xR-15-..	15	0.45 (0.26)	0.13	8	0.1	-	-	1000	C14	-06	-07	54
FN 9255 xR-16-..	16	0.45 (0.26)	0.3	0.7	0.1	-	-	1000	C20	-06	-07	130
FN 9255 xR-20-..	20	0.45 (0.26)	0.3	0.7	0.1	-	-	1000	C20	-06	-07	130

Test conditions: 25°C±2°C; Measuring frequency for Inductance: 1 kHz; 50 mV;

Tolerances: Inductance: +50%, -30%; Capacitance: ±25%; Resistor: ±15%; For mechanical tolerances refer to mechanical data section.

\* Maximum leakage under normal operating conditions (acc. to IEC60939-3). Note: if the neutral line is interrupted, worst case leakage could reach twice this level.

\*\* Standard length is 100 mm

#### Product selector

FN9255 wx -yy-...-(zz)

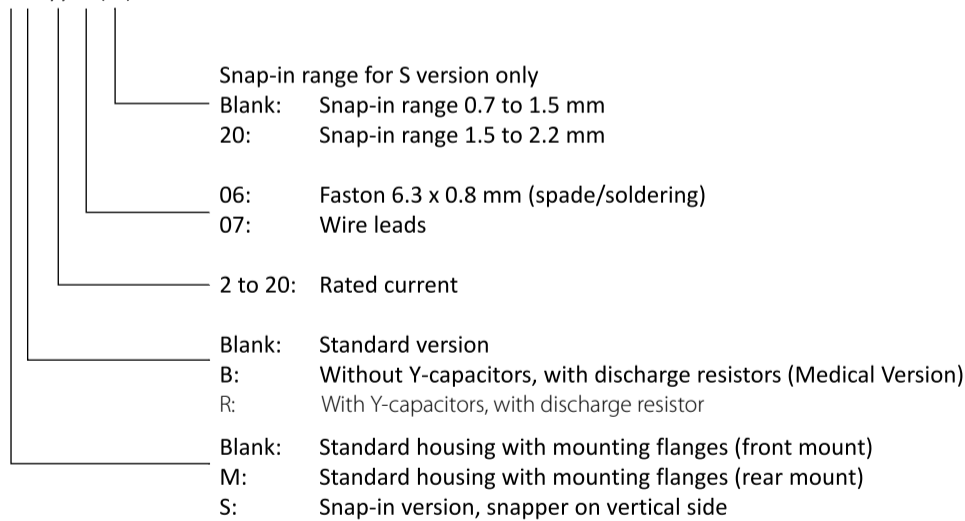

For example: FN 9255 MB-15-06 - FN 9255 dual stage IEC inlet with rear mount flanges, medical version, 15A rated current and fast-on terminals

### Detailed Electrical Schematic

Schematic standard version (2 to 15A)

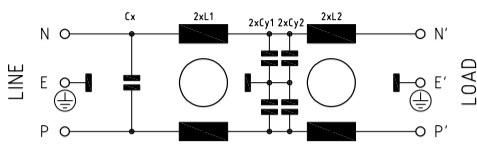

Schematic standard version (16 to 20A)

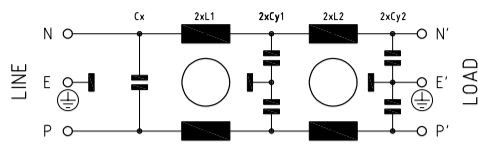

Schematic B version (2 to 20A)

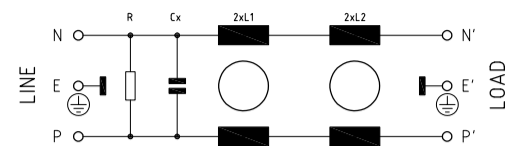

Schematic standard R version (2 to 15A)

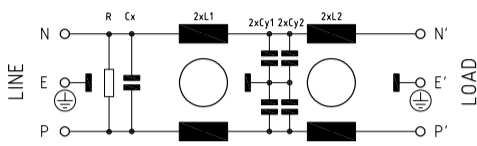

Schematic standard R version (16 to 20A)

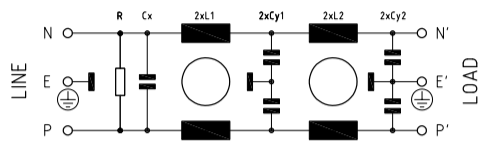

### Typical Filter Attenuation

Per CISPR 17 - symmetrical 50 Ω/50 Ω - Differential Mode (DM) - asymmetrical 50 Ω/50 Ω - Common Mode (CM)

2 A (Standard Type)

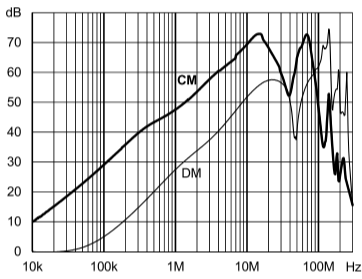

2 A (B Type)

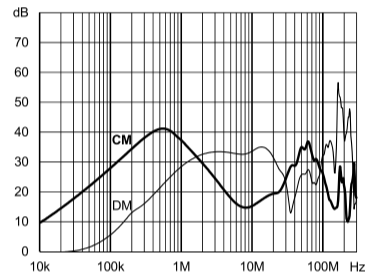

4 A (Standard Type)

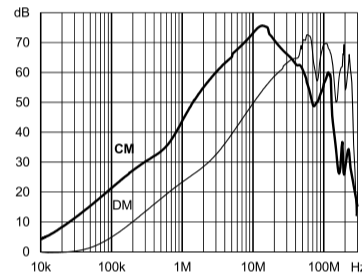

4 A (B Type)

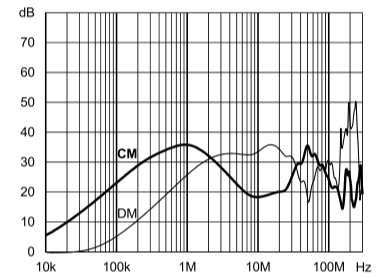

6 A (Standard Type)

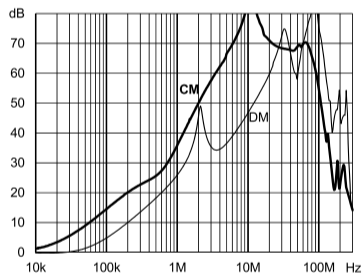

6 A (B Type)

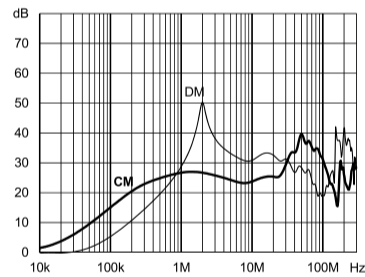

10 A (Standard Type)

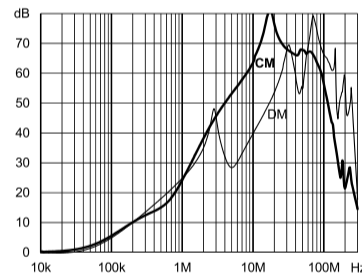

10 A (B Type)

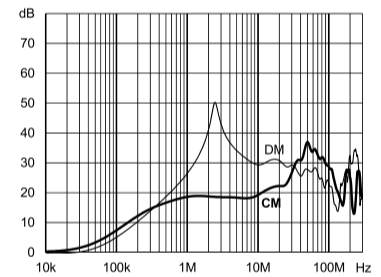

15 A (Standard Type)

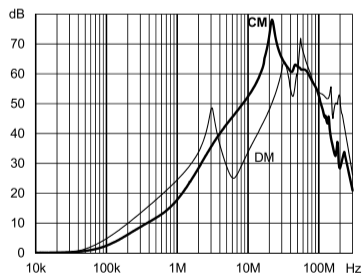

15 A (B Type)

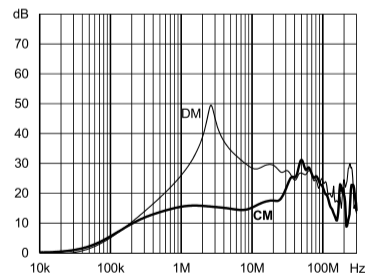

16 A (Standard Type)

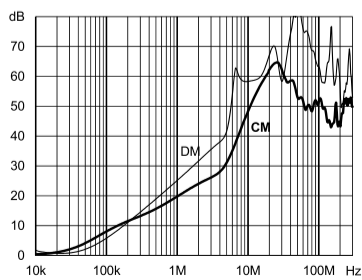

16 A (B Type)

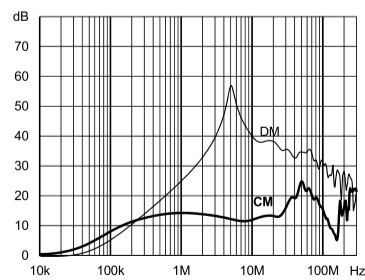

20 A (Standard Type)

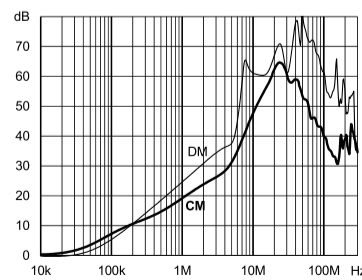

20 A (B Type)

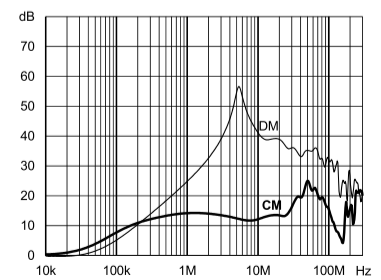

**Mechanical Data**

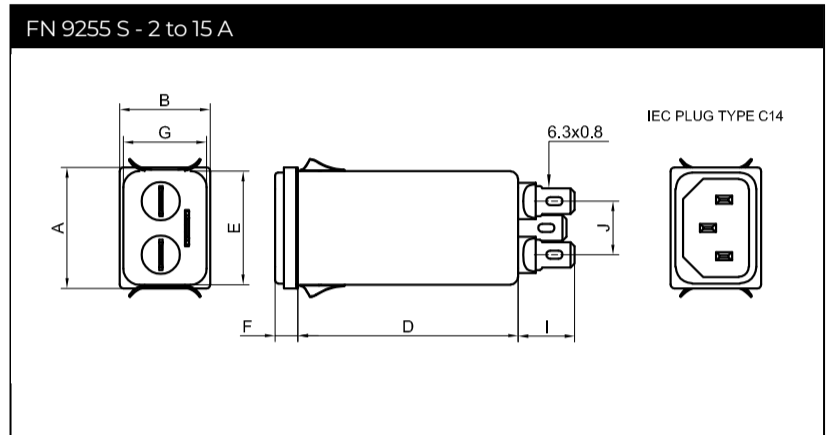
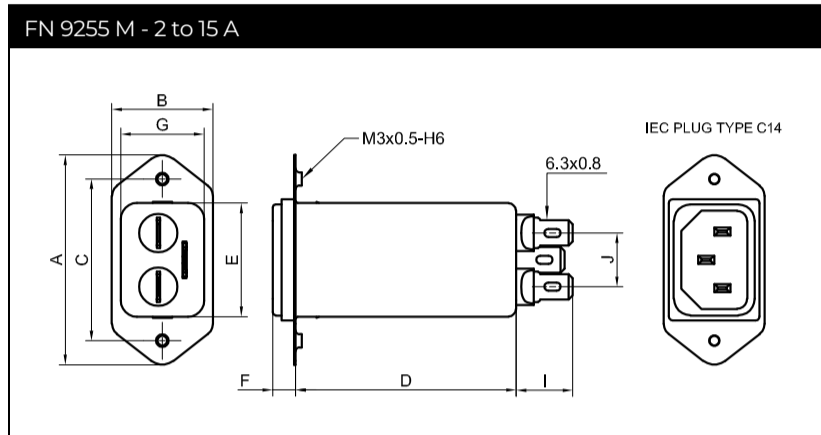
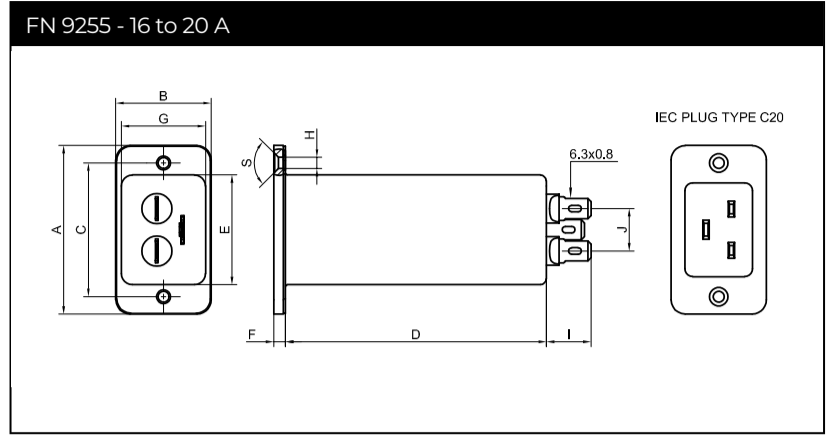
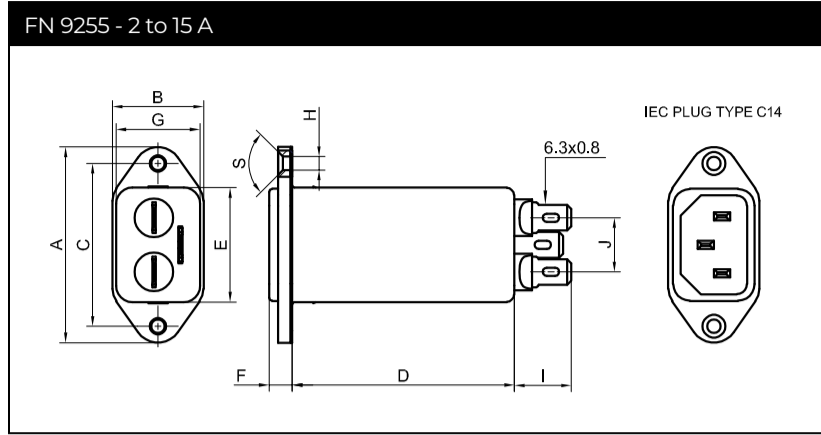

**Panel cut out**

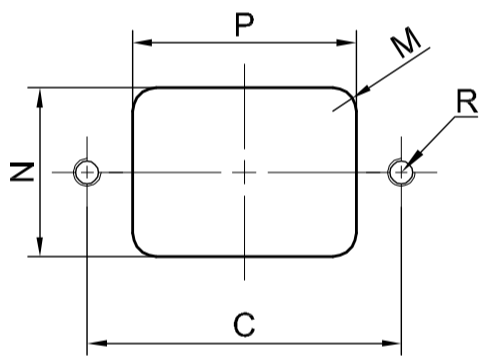

**-07 connection style**

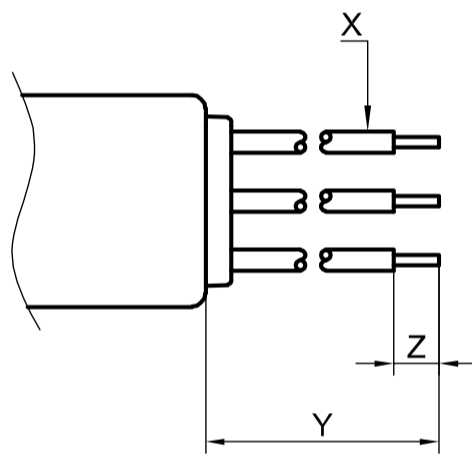

**Installation**

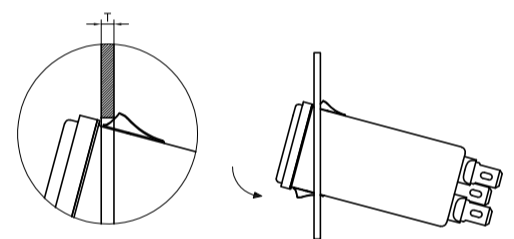

## Dimensions

		<b>FN 9255</b>	<b>FN 9255 M</b>	<b>FN 9255 S</b>
	2 to 15A	16 to 20A		
<b>A</b>	48	53	51.85	29.9
<b>B</b>	22.4	30	25	22.4
<b>C</b>	40±0.2	42±0.2	40±0.2	-
<b>D</b>	-06: 54.5, -07: 52.5	82	-06: 54.5, -07: 52.5	-06: 54.5, -07: 52.5
<b>E</b>	28.1±0.3	34.6±0.3	28.1±0.3	28.1±0.3
<b>F</b>	5.8±0.2	3.9±0.2	5.8±0.2	5.8±0.2
<b>G</b>	20.6±0.3	26.7±0.3	20.6±0.3	20.6±0.3
<b>H</b>	Ø3.3	Ø3.5	M3	M3
<b>I</b>	14±0.5	14±0.5	14±0.5	14±0.5
<b>J</b>	13.3	13.3	13.3	13.3
<b>M</b>	R ≤ 3	R ≤ 3	R ≤ 1	R ≤ 1
<b>N</b>	21.5 +0.5/-0	27.1 +0.2/-0	22.9 +0.2/-0	21.0 +0.1/-0
<b>P</b>	28.5 +0.5/-0	34.9 +0.2/-0	30.4 +0.2/-0	29.5 +0.1/-0
<b>R*</b>	M3	M3	Ø3.4	Ø3.4
<b>S</b>	90°	90°		
<b>T</b>				1.5 - 2.2
<b>X</b>	AWG 18 (>6A: AWG 16)	AWG 14	AWG 18 (>6A: AWG 16)	AWG 18 (>6A: AWG 16)
<b>Y</b>	100±5	100±5	100±5	100±5
<b>Z</b>	6	6	6	6

\*\*Recommended torque for M3 (90° countersunk flat head) is 0.5 Nm

All dimensions in mm; 1 inch = 25.4 mm

For values without dedicated tolerances ISO 2768-m/EN 22768-m applies.

Please visit [www.schaffner.com](http://www.schaffner.com) to find more details on connectors.

## Accessories

### Power Cord with Locking System



- Locking system for standardized IEC C14/C20 inlet filter
- No accidental disconnection
- Rated current up to 10 A (C13 plug), up to 15 A (C13P plug), and up to 20 A (C19 plug)
- Fits any Schaffner IEC C14/C20 inlet filter
- Retrofit for any IEC C14/C20 inlet
- Various power line plugs for international usage

[Technical Data Sheet >](#)

### IL 13P IEC C13 Rewireable Angled Connectors with Locking System



- Protects appliances that are vulnerable to vibration
- Connector cannot be accidentally pulled or vibrated out of the inlet
- Space availability/constraints
- Different angles for ease of access
- Space saving
- Release locking mechanism
- Prevents accidental disconnection

[Technical Data Sheet >](#)

### Power Cord with angled Locking System C13



- Protects appliances that are vulnerable to vibration
- Connector cannot be accidentally pulled or vibrated out of the inlet
- Space availability/constraints
- Different angles for ease of access
- Space saving
- Release locking mechanism
- Prevents accidental disconnection

[Technical Data Sheet >](#)

## Headquarters, Global Innovation and Development

### Switzerland

#### Schaffner Holding AG

Industrie Nord  
Nordstrasse 11e  
4542  
Luterbach  
+41 32 681 66 26  
[info@schaffner.com](mailto:info@schaffner.com)

## Sales and Application Centers

### China

#### Schaffner EMC Ltd. Shanghai

T20-3 C, No 565 Chuangye Road, Pudong district  
201201  
Shanghai  
+86 2138139500  
[cschina@schaffner.com](mailto:cschina@schaffner.com)

### Finland

#### Schaffner Oy

Sauvonrinne 19 H  
8500  
Lohja  
+358 50 468 7284  
[finlandsales@schaffner.com](mailto:finlandsales@schaffner.com)

### France

#### Schaffner EMC S.A.S.

16-20 Rue Louis Rameau  
95875  
Bezons  
+33 1 34 34 30 60  
[francesales@schaffner.com](mailto:francesales@schaffner.com)

### Germany

#### Schaffner Deutschland GmbH

Schoemperlenstrasse 12B  
76185  
Karlsruhe  
+49 721 56910  
[germanysales@schaffner.com](mailto:germanysales@schaffner.com)

### India

#### Schaffner India Pvt. Ltd

Regus World Trade Centre  
WTC, 22nd Floor Unit No 2238, Brigade Gateway Campus, 26/1, Dr. Rajkumar Road Malleshwaram (W)  
560055  
Bangalore  
+91 8067935355  
[indiasales@schaffner.com](mailto:indiasales@schaffner.com)

### Italy

#### Schaffner EMC S.r.l.

Via Ticino, 30  
20900  
Monza (MB)  
+39 039 21 41 070  
[italysales@schaffner.com](mailto:italysales@schaffner.com)

### Japan

#### Schaffner EMC K.K.

ISM Sangenjaya 7F  
1-32-12 Kamiuma, Setagaya-ku  
154-0011  
Tokyo  
+81 3 5712 3650  
[japansales@schaffner.com](mailto:japansales@schaffner.com)

### Singapore

#### Schaffner EMC Pte Ltd.

Blk 3015A Ubi Road 1, #05-09, Kampong Ubi Industrial Estate  
408705  
Singapore  
+65 63773283  
[singaporesales@schaffner.com](mailto:singaporesales@schaffner.com)

### Spain

#### Schaffner EMC España

Calle Caléndula 93, Miniparc III, Edificio E El Soto de Moraleja, Alcobendas  
28109  
Madrid  
+34 917 912 900  
[spainsales@schaffner.com](mailto:spainsales@schaffner.com)

### Sweden

#### Schaffner EMC AB

Östermalmstrorg 1  
114 42  
Stockholm  
+46 8 5050 2425  
[swedensales@schaffner.com](mailto:swedensales@schaffner.com)

### Switzerland

#### Schaffner EMV AG

Industrie Nord  
Nordstrasse 11e  
4542  
Luterbach  
+41 32 681 66 26  
[switzerlandsales@schaffner.com](mailto:switzerlandsales@schaffner.com)

### Taiwan

#### Schaffner EMV Ltd.

U-Town  
20 Floor-2, No 97, Section 1, XinTai 5th Road, XiZhi District  
22175  
New Taipei City  
+886 226975500  
[taiwansales@schaffner.com](mailto:taiwansales@schaffner.com)

### Thailand

#### Schaffner EMC Co. Ltd.

Sathorn Square Tower  
Room 3780, 37FL, 98 North-Sathorn Rd, Silom, Bangrak  
10500  
Bangkok  
+66 621056397  
[thailandsales@schaffner.com](mailto:thailandsales@schaffner.com)

### United Kingdom

#### Schaffner Ltd.

1, Oakmede Place  
Terrace Road  
RG42 4JF  
Binfield  
+44 118 9770070  
[uksales@schaffner.com](mailto:uksales@schaffner.com)

### United States

#### Schaffner EMC Inc.

52 Mayfield Avenue  
Edison, New Jersey  
+1 732 225 9533  
[usasales@schaffner.com](mailto:usasales@schaffner.com)

To find your local partner within Schaffner's global network [schaffner.com](http://schaffner.com)

© 2022 Schaffner Group

The content of this document has been carefully checked and understood. However, neither Schaffner nor its subsidiaries assume any liability whatsoever for any errors or inaccuracies of this document and the consequences thereof. Published specifications are subject to change without notice. Product suitability for any area of application must ultimately be determined by the customer. In all cases, products must never be operated outside their published specifications. Schaffner does not guarantee the availability of all published products. This disclaimer shall be governed by substantive Swiss law and resulting disputes shall be settled by the courts at the place of business of Schaffner Holding AG. Latest publications and a complete disclaimer can be downloaded from the Schaffner website. All trademarks recognized.