

# IRF7204PbF

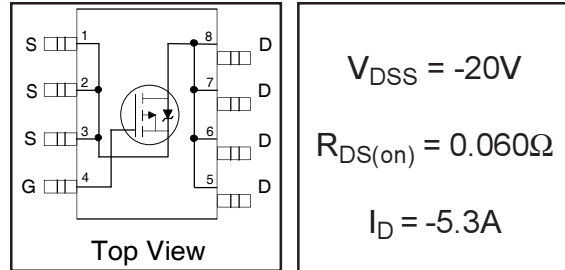
HEXFET® Power MOSFET

- Advanced Process Technology
- Ultra Low On-Resistance
- P-Channel MOSFET
- Surface Mount
- Available in Tape & Reel
- Dynamic dv/dt Rating
- Fast Switching
- Lead-Free

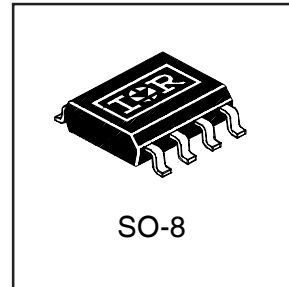
## Description

Fourth Generation HEXFETs from International Rectifier utilize advanced processing techniques to achieve the lowest possible on-resistance per silicon area. This benefit, combined with the fast switching speed and ruggedized device design that HEXFET Power MOSFETs are well known for, provides the designer with an extremely efficient device for use in a wide variety of applications.

The SO-8 has been modified through a customized leadframe for enhanced thermal characteristics and dual-die capability making it ideal in a variety of power applications. With these improvements, multiple devices can be used in an application with dramatically reduced board space. The package is designed for vapor phase, infra red, or wave soldering techniques. Power dissipation of greater than 0.8W is possible in a typical PCB mount application.



$V_{DSS} = -20V$
$R_{DS(on)} = 0.060\Omega$
$I_D = -5.3A$



## Absolute Maximum Ratings

	Parameter	Max.	Units
$I_D @ T_A = 25^\circ C$	Continuous Drain Current, $V_{GS} @ 10V$	-5.3	A
$I_D @ T_A = 70^\circ C$	Continuous Drain Current, $V_{GS} @ 10V$	-4.2	
$I_{DM}$	Pulsed Drain Current ①	-21	
$P_D @ T_C = 25^\circ C$	Power Dissipation	2.5	W
	Linear Derating Factor	0.020	W/°C
$V_{GS}$	Gate-to-Source Voltage	$\pm 12$	V
dv/dt	Peak Diode Recovery dv/dt ②	-1.7	V/nS
$T_J, T_{STG}$	Junction and Storage Temperature Range	-55 to + 150	°C

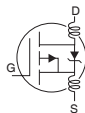
## Thermal Resistance Ratings

	Parameter	Min.	Typ.	Max.	Units
$R_{\theta JA}$	Maximum Junction-to-Ambient ④	—	—	50	°C/W

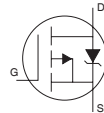
# IRF7204PbF

International  
IR Rectifier

## Electrical Characteristics @ $T_J = 25^\circ\text{C}$ (unless otherwise specified)

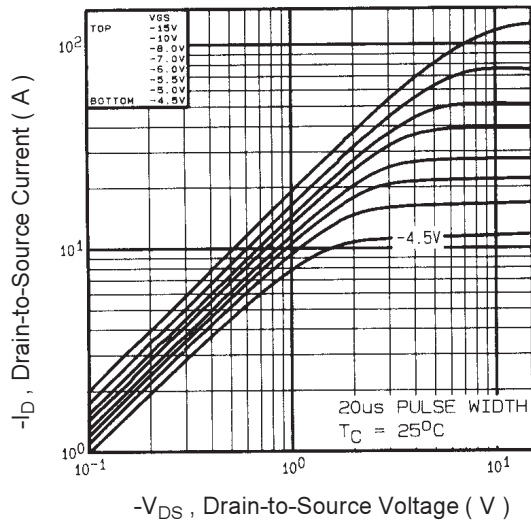
	Parameter	Min.	Typ.	Max.	Units	Conditions
$V_{(BR)DSS}$	Drain-to-Source Breakdown Voltage	-20	—	—	V	$V_{GS} = 0V, I_D = -250\mu A$
$\Delta V_{(BR)DSS}/\Delta T_J$	Breakdown Voltage Temp. Coefficient	—	-0.022	—	V/°C	Reference to $25^\circ\text{C}$ , $I_D = -1\text{mA}$
$R_{DS(ON)}$	Static Drain-to-Source On-Resistance	—	—	0.060	$\Omega$	$V_{GS} = -10V, I_D = -5.3A$ ③
		—	—	0.10		$V_{GS} = -4.5V, I_D = -2.0A$ ③
$V_{GS(th)}$	Gate Threshold Voltage	-1.0	—	-2.5	V	$V_{DS} = V_{GS}, I_D = -250\mu A$
$g_{fs}$	Forward Transconductance	—	7.9	—	S	$V_{DS} = -15V, I_D = -5.3A$ ③
$I_{DSS}$	Drain-to-Source Leakage Current	—	—	-25	$\mu A$	$V_{DS} = -16V, V_{GS} = 0V$
		—	—	-250		$V_{DS} = -16V, V_{GS} = 0V, T_J = 125^\circ\text{C}$
$I_{GSS}$	Gate-to-Source Forward Leakage	—	—	-100	nA	$V_{GS} = -12V$
	Gate-to-Source Reverse Leakage	—	—	100		$V_{GS} = 12V$
$Q_g$	Total Gate Charge	—	25	—	nC	$I_D = -5.3A$
$Q_{gs}$	Gate-to-Source Charge	—	5.0	—		$V_{DS} = -10V$
$Q_{gd}$	Gate-to-Drain ("Miller") Charge	—	8.0	—		$V_{GS} = -10V$ ③
$t_{d(on)}$	Turn-On Delay Time	—	14	30	ns	$V_{DD} = -10V$ $I_D = -1.0A$ $R_G = 6.0\Omega$ $R_D = 10\Omega$ ③
$t_r$	Rise Time	—	26	60		
$t_{d(off)}$	Turn-Off Delay Time	—	100	150		
$t_f$	Fall Time	—	68	100		
$L_D$	Internal Drain Inductance	—	2.5	—	nH	Between lead, 6mm (0.25in.) from package and center of die contact 
$L_S$	Internal Source Inductance	—	4.0	—		
$C_{iss}$	Input Capacitance	—	860	—	pF	$V_{GS} = 0V$ $V_{DS} = -10V$ $f = 1.0\text{MHz}$
$C_{oss}$	Output Capacitance	—	750	—		
$C_{rss}$	Reverse Transfer Capacitance	—	230	—		

## Source-Drain Ratings and Characteristics

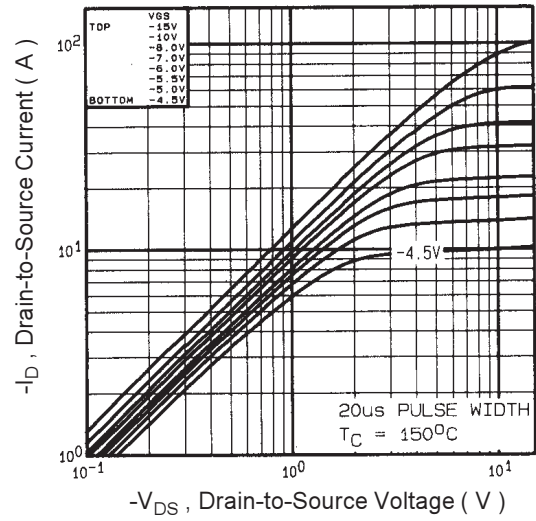
	Parameter	Min.	Typ.	Max.	Units	Conditions
$I_S$	Continuous Source Current (Body Diode)	—	—	-2.5	A	MOSFET symbol showing the integral reverse p-n junction diode. 
$I_{SM}$	Pulsed Source Current (Body Diode) ①	—	—	-15		
$V_{SD}$	Diode Forward Voltage	—	—	-1.2	V	$T_J = 25^\circ\text{C}, I_S = -1.25A, V_{GS} = 0V$ ③
$t_{rr}$	Reverse Recovery Time	—	85	100	ns	$T_J = 25^\circ\text{C}, I_F = -2.4A$
$Q_{rr}$	Reverse Recovery Charge	—	77	120	nC	$di/dt = 100A/\mu s$ ③
$t_{on}$	Forward Turn-On Time	Intrinsic turn-on time is negligible (turn-on is dominated by $L_S + L_D$ )				

### Notes:

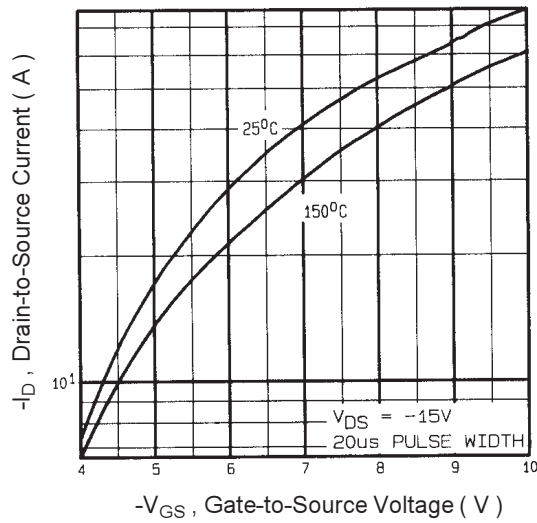
- ① Repetitive rating; pulse width limited by max. junction temperature.
- ②  $I_{SD} \leq -5.3A, di/dt \leq 90A/\mu s, V_{DD} \leq V_{(BR)DSS}, T_J \leq 150^\circ\text{C}$
- ③ Pulse width  $\leq 300\mu s$ ; duty cycle  $\leq 2\%$ .
- ④ Surface mounted on FR-4 board,  $t \leq 10\text{sec}$ .



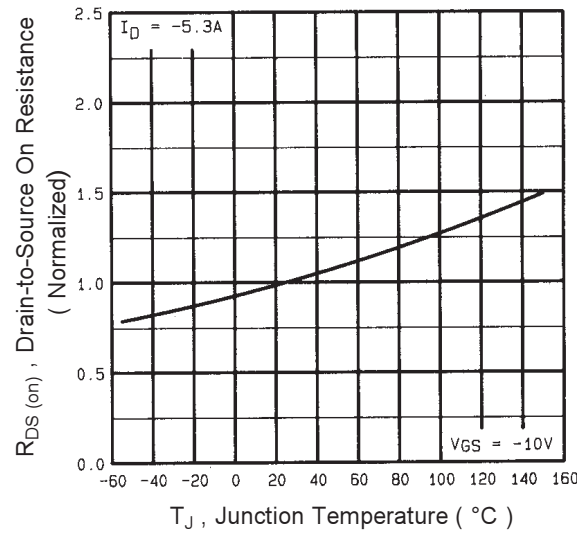
**Fig 1.** Typical Output Characteristics



**Fig 2.** Typical Output Characteristics



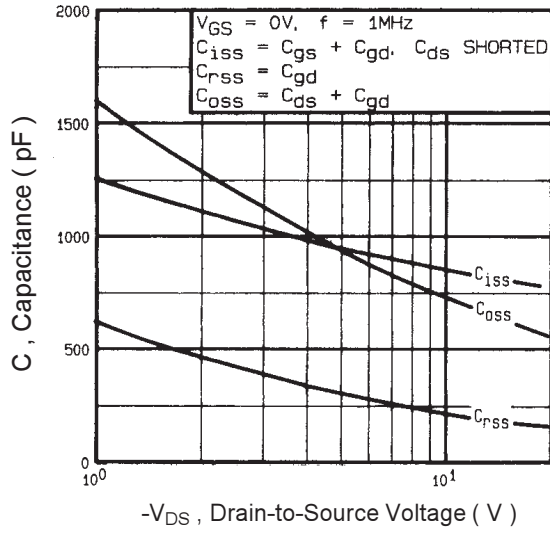
**Fig 3.** Typical Transfer Characteristics



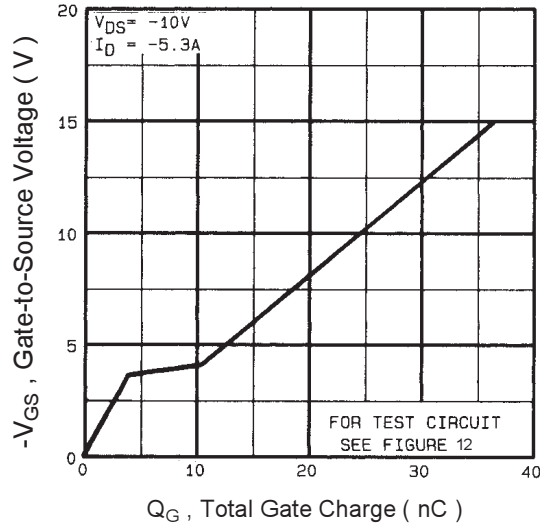
**Fig 4.** Normalized On-Resistance Vs. Temperature

# IRF7204PbF

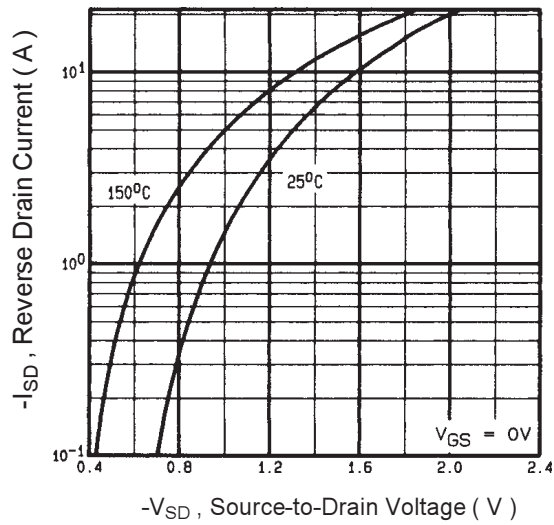
International  
**IR** Rectifier



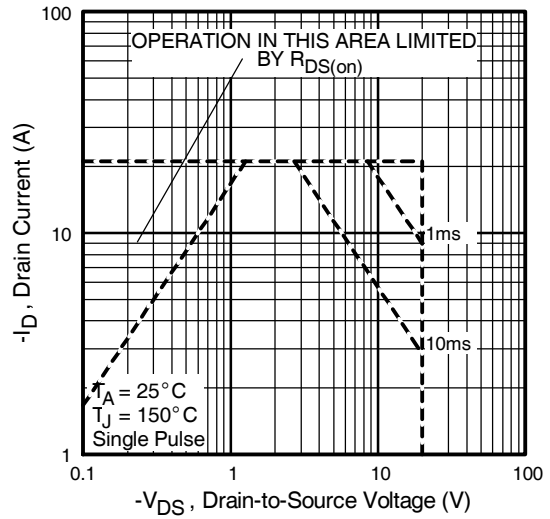
**Fig 5.** Typical Capacitance Vs. Drain-to-Source Voltage



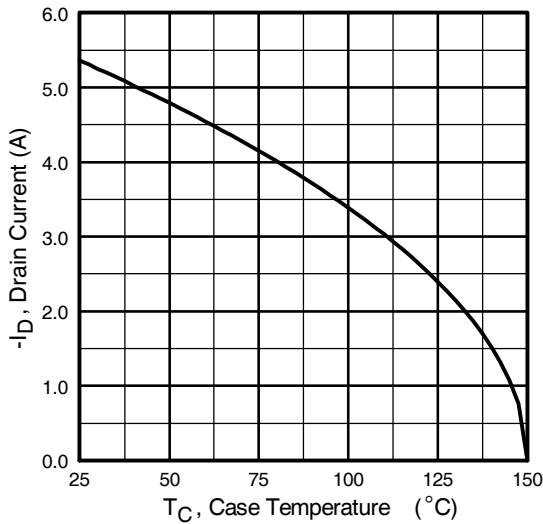
**Fig 6.** Typical Gate Charge Vs. Gate-to-Source Voltage



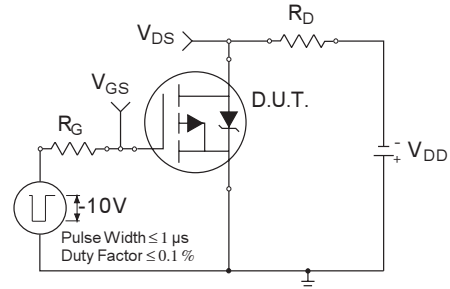
**Fig 7.** Typical Source-Drain Diode Forward Voltage



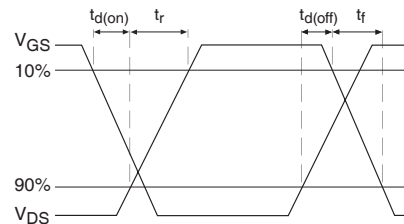
**Fig 8.** Maximum Safe Operating Area



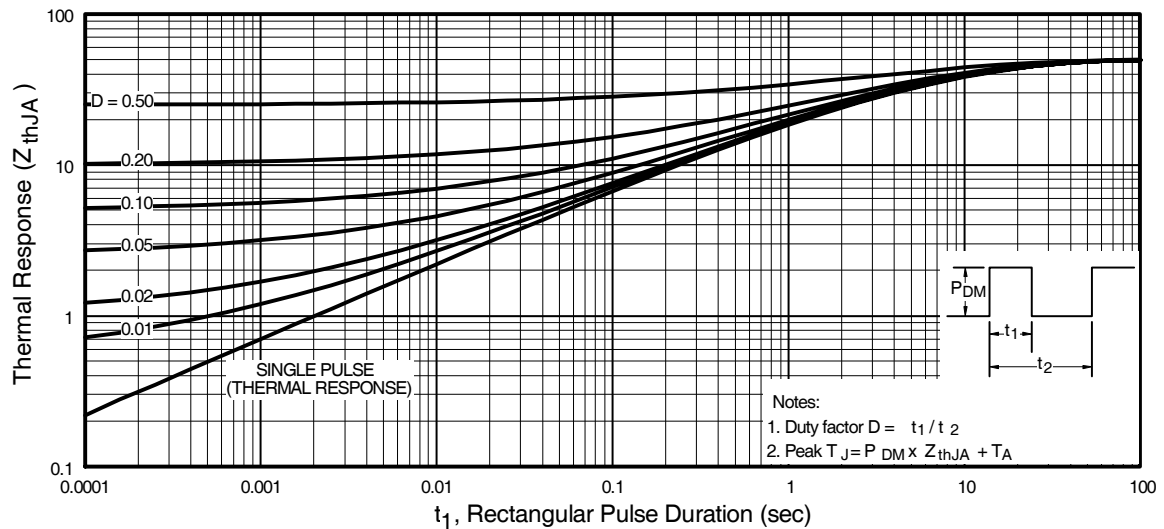
**Fig 9.** Maximum Drain Current Vs. Ambient Temperature



**Fig 10a.** Switching Time Test Circuit



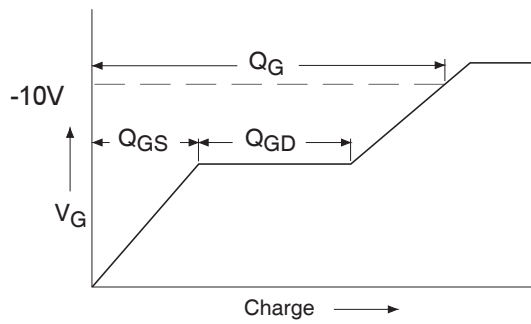
**Fig 10b.** Switching Time Waveforms



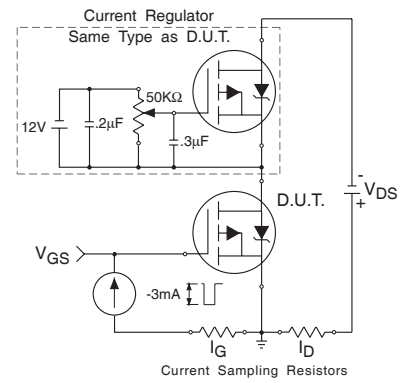
**Fig 11.** Maximum Effective Transient Thermal Impedance, Junction-to-Ambient

# IRF7204PbF

International  
**IR** Rectifier

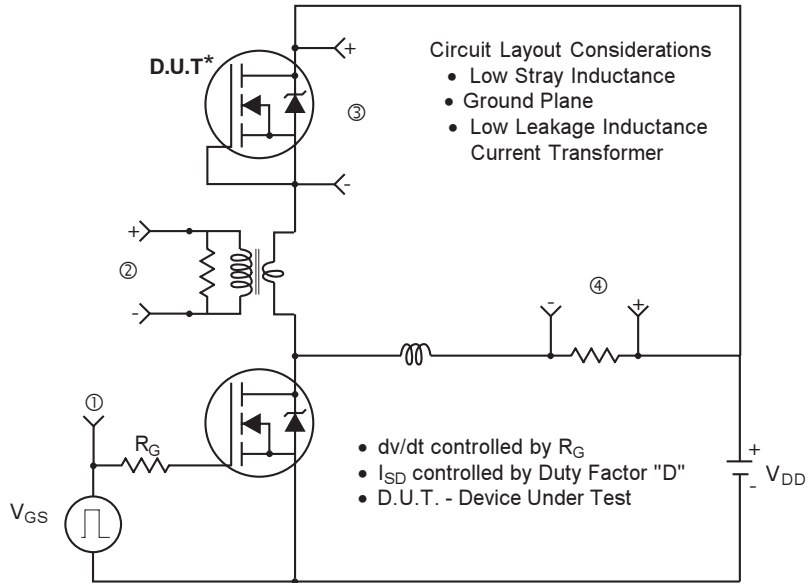


**Fig 12a.** Basic Gate Charge Waveform

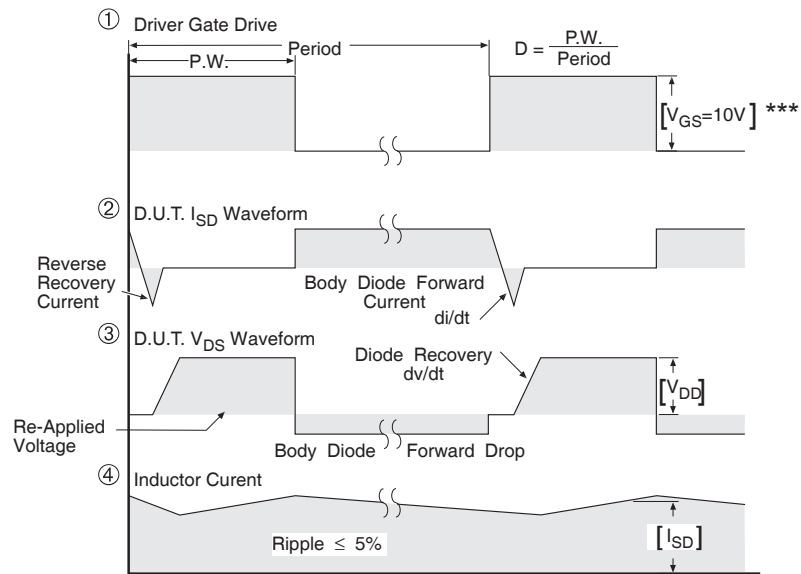


**Fig 12b.** Gate Charge Test Circuit

## Peak Diode Recovery dv/dt Test Circuit



\* Reverse Polarity of D.U.T for P-Channel



\*\*\*  $V_{GS} = 5.0V$  for Logic Level and 3V Drive Devices

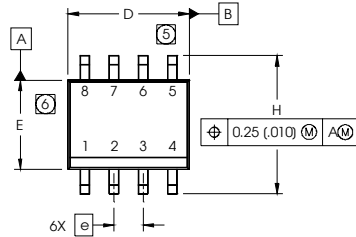
**Fig 13.** For P-Channel HEXFETS

# IRF7204PbF

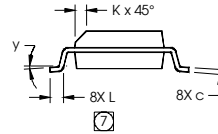
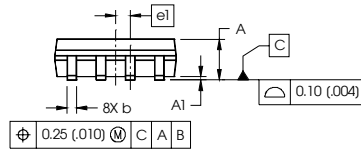


## SO-8 Package Outline

Dimensions are shown in millimeters (inches)



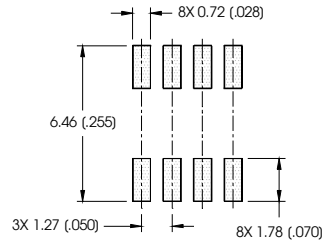
DIM	INCHES		MILLIMETERS	
	MIN	MAX	MIN	MAX
A	.0532	.0688	1.35	1.75
A1	.0040	.0098	0.10	0.25
b	.013	.020	0.33	0.51
c	.0075	.0098	0.19	0.25
D	.189	.1968	4.80	5.00
E	.1497	.1574	3.80	4.00
e	.050 BASIC		1.27 BASIC	
e1	.025 BASIC		0.635 BASIC	
H	.2284	.2440	5.80	6.20
K	.0099	.0196	0.25	0.50
L	.016	.050	0.40	1.27
y	0°	8°	0°	8°



**NOTES:**

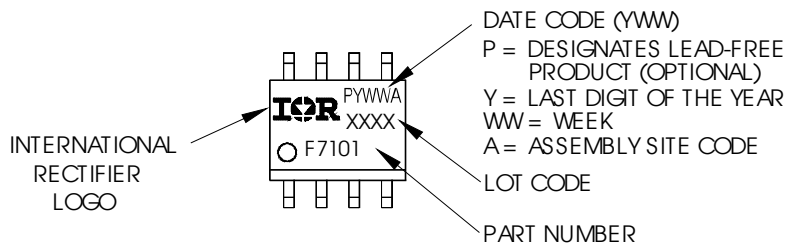
1. DIMENSIONING & TOLERANCING PER ASME Y14.5M-1994.
2. CONTROLLING DIMENSION: MILLIMETER
3. DIMENSIONS ARE SHOWN IN MILLIMETERS (INCHES).
4. OUTLINE CONFORMS TO JEDEC OUTLINE MS-012AA
5. DIMENSION DOES NOT INCLUDE MOLD PROTRUSIONS. MOLD PROTRUSIONS NOT TO EXCEED 0.15 (0.006).
6. DIMENSION DOES NOT INCLUDE MOLD PROTRUSIONS. MOLD PROTRUSIONS NOT TO EXCEED 0.25 (0.010).
7. DIMENSION IS THE LENGTH OF LEAD FOR SOLDERING TO SUBSTRATE.

**FOOTPRINT**



## SO-8 Part Marking Information (Lead-Free)

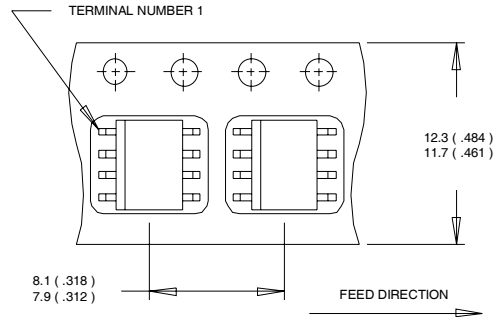
EXAMPLE: THIS IS AN IRF7101 (MOSFET)



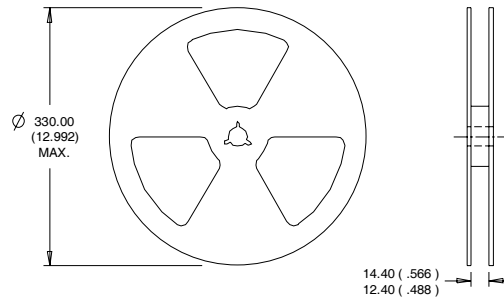


## SO-8 Tape and Reel

Dimensions are shown in millimeters (inches)



- NOTES:
1. CONTROLLING DIMENSION : MILLIMETER.
  2. ALL DIMENSIONS ARE SHOWN IN MILLIMETERS(INCHES).
  3. OUTLINE CONFORMS TO EIA-481 & EIA-541.



- NOTES :
1. CONTROLLING DIMENSION : MILLIMETER.
  2. OUTLINE CONFORMS TO EIA-481 & EIA-541.

Data and specifications subject to change without notice.  
 This product has been designed and qualified for the Consumer market.  
 Qualifications Standards can be found on IR's Web site.

International  
**IR** Rectifier

**IR WORLD HEADQUARTERS:** 233 Kansas St., El Segundo, California 90245, USA Tel: (310) 252-7105  
 TAC Fax: (310) 252-7903  
 Visit us at [www.irf.com](http://www.irf.com) for sales contact information.10/04

## **IMPORTANT NOTICE**

The information given in this document shall in no event be regarded as a guarantee of conditions or characteristics ("Beschaffheitsgarantie").

With respect to any examples, hints or any typical values stated herein and/or any information regarding the application of the product, Infineon Technologies hereby disclaims any and all warranties and liabilities of any kind, including without limitation warranties of non-infringement of intellectual property rights of any third party.

In addition, any information given in this document is subject to customer's compliance with its obligations stated in this document and any applicable legal requirements, norms and standards concerning customer's products and any use of the product of Infineon Technologies in customer's applications.

The data contained in this document is exclusively intended for technically trained staff. It is the responsibility of customer's technical departments to evaluate the suitability of the product for the intended application and the completeness of the product information given in this document with respect to such application.

For further information on the product, technology, delivery terms and conditions and prices please contact your nearest Infineon Technologies office ([www.infineon.com](http://www.infineon.com)).

## **WARNINGS**

Due to technical requirements products may contain dangerous substances. For information on the types in question please contact your nearest Infineon Technologies office.

Except as otherwise explicitly approved by Infineon Technologies in a written document signed by authorized representatives of Infineon Technologies, Infineon Technologies' products may not be used in any applications where a failure of the product or any consequences of the use thereof can reasonably be expected to result in personal injury.