

ZM & ZM1 SERIES

004991

Issue 4

MICRO SWITCH Subminiature Switches



DESCRIPTION

MICRO SWITCH ZM and ZM1 Series are subminiature snap action switches from the Honeywell MICRO SWITCH family of Z Series subminiature basic switches. Although small in size, the ZM and ZM1 Series are rated for controlling electrical loads ranging from logic level (computer based circuits) to power duty switching (up to 16.1 A and 250 Vac).

The package size of the subminiature switch is ideal for applications where space on the equipment is at a premium. The overall length of the ZM and ZM1 Series are less than 20 mm [0.78 in]. As with all snap-action switches, the audible click when actuated promotes ease of installation and set-up of the switches. A wide variety of integral stainless steel levers are available and when combined with the subminiature package size, may adapt the switch to a wide variety of applications. The ZM Series is agency certified to UL, cUL and CQC for worldwide use, while the ZM1 Series is agency certified to UL, cUL, ENEC, CE, UKCA and CQC for worldwide use.

FEATURES

- Subminiature package size (19,80 mm x 10,60 mm x 6,40 mm [0.78 in x 0.42 in x 0.25 in]) allows switch to fit in applications where other sensor or switch package size is too large.
- Well suited for power-duty and logic-level loads
- SPDT, SPNC, or SPNO switch options help assure the circuit requirements are met
- Switches are built with pin plunger or various styles of stainless steel levers
- MICRO SWITCH ZM and ZM1 products are certified per UL; cUL to UL 61058-1; CE & UKCA to EN 61058-1; and CQC to GB 15092.1

POTENTIAL APPLICATIONS

Commercial

- Copy machines: Senses paper position
- Cash registers: Senses drawer open or closed
- Refrigerators with integral ice makers: Turns water on-and-off
- HVAC: Senses back pressure in exhaust outlet
- HVAC: Senses float position for water level

Medical

- Hospital beds: Senses bed rail position

VALUE TO CUSTOMERS

- Temperature ranges from -40 °C to 125 °C [-40 °F to 257 °F] typically allows for years of reliable performance in harsh conditions
- Choice of internal switch mechanism: ZM Series with coil spring design for increased mechanical life or ZM1 Series with flat spring design for increased electrical rating
- Current carrying capacity, up to 16.1 A (ZM1 Series), typically allows for a solution in many applications where space is a premium
- Wide variety of electrical ratings, integral actuators, and electrical terminations to facilitate integration into control and/or monitoring circuits

PORTFOLIO



The ZM and ZM1 Series are part of the MICRO SWITCH subminiature basic switch family that also includes HD, HD1, SM, SX, ZD, ZW and ZX.

Honeywell

MICRO SWITCH SUBMINIATURE BASIC SWITCHES

ZM & ZM1 SERIES

TABLE 1. MICRO SWITCH ZM SERIES SPECIFICATIONS

Characteristic	ZM10 Series (Logic Level)	ZM50 Series (Standard Duty)	ZM90 Series (Power Duty)
Circuitry	SPDT, SPNC, SPNO		
Operating force (at pin plunger)	60 g, 104 g, 146 g, 249 g	104 g, 146 g, 249 g	249 g
Termination	Solder (standard and extended), PCB (standard, left, or right)		
Sealing	IP40		
Actuators, pin plunger standard Levers (300 series stainless steel)	pin plunger, straight lever (5 lengths), simulated roller lever (3 styles), roller lever, L-shaped lever, special levers		
Agency certification	UL, cUL, CQC, RoHS and Reach compliant		
Operating temperature (manufacturer rated)	-40 °C to 125 °C [-40 °F to 257 °F]		
Mechanical endurance (cycles)	5,000,000 min. @ 400 cycles/minute max.		
Switch resistance (initial)	100 mΩ max.	100 mΩ max.	300 mΩ max.
Insulation resistance (initial)	100 MΩ min. (500 Vdc for 1 minute)		
Dielectric strength (initial) (between live parts and ground)	1500 V RMS for one minute (≤0.5 ma leakage current)		
Plunger material	PA (nylon)		
Case/cover material	PA (nylon)		
Contact material	gold-plated silver alloy	silver alloy	silver alloy

Note: Refer to engineering drawing for additional information.

TABLE 2. MICRO SWITCH ZM SERIES ELECTRICAL RATINGS

Switch option	UL/cUL per UL 61058-1 File E12252, Temp 120 °C [248 °F]	CQC per GB15092.1 0 °C to 125 °C [32 °F to 257 °F] μ (micro-disconnection)
ZM10 Series (Gold-plated silver alloy contacts)	0.1 RA 30 Vdc, 10,000 cycles min. 0.1 RA 125/250 Vac, 10,000 cycles min.	0.1 A 30 Vdc 0.1 A 125/250 Vac 10,000 cycles
ZM50 Series (Silver alloy contacts)	5 RA 30 Vdc, 10,000 cycles min. 5 RA 125/250 Vac, 10,000 cycles min.	5 A 125/250 Vac 10,000 cycles
ZM90 Series (Silver alloy contacts)	10.1 GPA 125/250 Vac, 10,000 cycles min.	10.1 A 125/250 Vac 10,000 cycles

MICRO SWITCH SUBMINIATURE BASIC SWITCHES

ZM & ZM1 SERIES

TABLE 3. MICRO SWITCH ZM1 SERIES SPECIFICATIONS

Characteristic	ZM110 Series, ZM115 Series (Logic Level)	ZM150 Series, ZM155 Series, ZM160 Series (Standard Duty)	ZM190 Series, ZM195 Series (Power Duty)
Circuitry	SPDT, SPNC, SPNO		
Operating force (at pin plunger)	70 g, 95 g, 150 g	70 g, 95 g, 150 g	ZM190: 150 g, 355 g ZM195: 355 g
Termination	solder (standard and extended); PCB (standard, left, or right), special termination		
Sealing	IP40		
Actuators, pin plunger standard Levers (300 series stainless steel)	pin plunger, straight lever (5 lengths), simulated roller lever (3 styles), roller lever, L-shaped lever, special levers		
Agency certification	UL, cUL, CQC, ENEC, CE, UKCA, RoHS and Reach compliant		
Operating temperature (manufacturer rated)	ZM110: -40 °C to 125 °C [-40 °C to 257 °F] ZM115: 0 °C to 85 °C [32 °F to 185 °F]	ZM150, ZM160: -40 °C to 125 °C [-40 °C to 257 °F] ZM155: 0 °C to 85 °C [32 °F to 185 °F]	-40 °C to 125 °C [-40 °C to 257 °F]
Mechanical endurance (cycles)* 120 cycles/minute max.	1,000,000 min.	1,000,000 min.	ZM190 (150 G OF): 1,000,000 min. ZM190 (355 g OF): 50,000 min. ZM195: 50,000 min.
Switch resistance (initial)	300 mΩ max.		
Insulation resistance (initial)	100 MΩ min. (500 Vdc for 1 minute)		
Dielectric strength (initial) (between live parts and ground)	1500 V RMS for one minute (≤0.5 ma leakage current)		
Plunger material	PA (nylon)		
Case/cover material	PBT (polyester)	PBT (polyester)	PA (nylon)
Contact material	silver alloy	silver alloy	silver alloy
Contact material (optional)	gold-plated silver alloy (ZM115 only)	gold-plated silver alloy (ZM115 only)	–

Note: Refer to engineering drawing for additional information

*Refer to engineering drawing for additional detail of mechanical endurance

TABLE 4. MICRO SWITCH ZM1 SERIES ELECTRICAL RATINGS

Switch option	UL/cUL per 61058-1 File E12252	ENEC per IEC 61058-1 μ (Micro-disconnection)	CQC per GB 15092.1 μ (Micro-disconnection)
ZM110 Series	0.1 RA 125/250 Vac, 10,000 cycles min. 125 °C [257 °F]	0.1 A 125/250 Vac, 10,000 cycles -40 °C to 125 °C [-40 °F to 257 °F]	
ZM115 Series	0.1 RA 125/250 Vac, 10,000 cycles min. 85 °C [185 °F]	0.1 A 125/250 Vac, 10,000 cycles 0 °C to 85 °C [32 °F to 185 °F]	
ZM150 Series	3 RA 125/250 Vac, 10,000 cycles min. 125 °C [257 °F]	3 A 125/250 Vac, 10,000 cycles -40 °C to 125 °C [-40 °F to 257 °F]	
ZM155 Series	3 RA 125/250 Vac, 10,000 cycles min. 85 °C [185 °F]	3 A 125/250 Vac, 10,000 cycles 0 °C to 85 °C [32 °F to 185 °F]	
ZM160 Series	6 RA 125/250 Vac, 10,000 cycles min. 125 °C [257 °F]	6 A 125/250 Vac, 6 (2) A 125/250 Vac, 10,000 cycles -40 °C to 125 °C [-40 °F to 257 °F]	
ZM190 Series	10.1 GPA 125/250 Vac, 10,000 cycles min. 125 °C [257 °F]	10.1 A 125/250 Vac, 6 (2) A 125/250 Vac, 10,000 cycles -40 °C to 125 °C [-40 °F to 257 °F]	
ZM195 Series	16.1 GPA 125/250 Vac 10,000 cycles min. 55 °C [131 °F]	16.1 (4) A 125/250 Vac 10,000 cycles -40 °C to 85 °C [-40 °F to 185 °F] 16.1 A 125/250 Vac 6 (3) A 125/250 Vac 10,000 cycles -40 °C to 125 °C [-40 °F to 257 °F]	16.1 A 125/250 Vac 6 (3) A 125/250 Vac 10,000 cycles -40 °C to 125 °C [-40 °F to 257 °F]

RA – Resistive Amps (Resistive Load), GPA – General Purpose Amps (Inductive Load), X (Y) – X is max. resistive amps., and (Y) is max. inductive amps.

MICRO SWITCH SUBMINIATURE BASIC SWITCHES ZM & ZM1 SERIES

MICRO SWITCH ZM SERIES PRODUCT NOMENCLATURE

ZM	50	E	10	E	01	—
Switch Type	Current Rating	Operating Force (at pin plunger)	Terminal Type	Actuator Type (Integral Levers)	Circuitry	Special Designator ²
ZM Series Subminiature Basic Switch	10 0.1 A 125 Vac (Gold-plated contacts)	B 60 g max. D 104 g max. E 146 g max. G 249 g max.	10 Solder, straight	A Pin plunger	01 SPDT	A special designator character(s) is used when there is a special modification to the switch. A special designator is required when Terminal Type is "99" or Actuator Type is "S".
	50 5 A; 125 Vac/ 250 Vac	D 104 g max. E 146 g max. G 249 g max.	20 PCB, straight	B Short straight lever, 16,7 mm [0.66 in] length	03 SPNO	
	90 10.1 A; 125 Vac/ 250 Vac ¹	G 249 g max.	50 PCB, right angle	C Standard straight lever, 18,7 mm [0.74 in] length	04 SPNC	
			60 PCB, left angle	D Long straight lever, 24,8 mm [0.98 in] length		
			70 Quick connect 0.110 in	E Std sim. roller lever, 18,0 mm [0.71 in] length, R 2,75 mm		
			99 SPECIAL ²	F Roller lever, 16,6 mm [0.65 in] length Ø4,8 mm roller		
				H Small sim. roller lever, 17,9 mm [0.70 in] length, R 1,3 mm		
				J Extended straight lever, 55,2 mm [2.17 in] length		
				K Straight lever, 35,2 mm [1.39 in] length		
			L L-shaped lever, 31,5 mm [1.24 in] length			
			M Large sim. roller lever, 21,1 mm [0.83 in] length, R 2,45 mm			
			S SPECIAL lever ²			

Not all combinations of model code are available.
Please contact your Honeywell representative or distributor for assistance.

NOTES:

¹ Switches with 10.1 A rating are only available with "G" operating force.

² Terminal Type "99" or Actuator Type "S" designates a special and therefore requires a special designator character(s) at the end of the listing.

MICRO SWITCH SUBMINIATURE BASIC SWITCHES ZM & ZM1 SERIES

MICRO SWITCH ZM1 SERIES PRODUCT NOMENCLATURE

ZM1	50	C	10	A	01	—	
Switch Type	Current Rating	Operating Force (at pin plunger)	Terminal Type	Actuator Type	Circuitry	Special Designator ²	
ZM1 Series Subminiature Basic Switch	10 15 ⁶	0.1 A 125 Vac/ 250 Vac ³	B D C	70 g max. 95 g max. 150 g max.	10	Solder, straight	A special designator character(s) is used when there is a special modification to the switch. A special designator is required when Terminal Type is "99" or Actuator Type is "S". G – Gold plated contacts ⁶
	50 55 ⁶	3 A; 125 Vac/ 250 Vac ³	B D C	70 g max. 95 g max. 150 g max.	20	PCB, straight	
	60	6 A; 125 Vac/ 250 Vac ³	B D C	70 g max. 95 g max. 150 g max.	50	PCB, right angle	
	90	10.1 A; 125 Vac/ 250 Vac ⁴	C G	150 g max. 355 g max.	60	PCB, left angle	
	95	16.1 A; 125 Vac/ 250 Vac ⁵	G	355 g max.	70	Quick connect 0.110 in	
					99	SPECIAL ²	
				A	Pin plunger		
				B	Short straight lever, 16,7 mm [0.66 in] length	01	SPDT
				C	Standard straight lever, 18,7 mm [0.74 in] length	03	SPST-NO
				D	Long straight lever, 24,8 mm [0.98 in] length	04	SPST-NC
				E	Std sim. roller lever, 18,0 mm [0.71 in] length, R 2,75 mm		
				F	Roller lever, 16,6 mm [0.65 in] length Ø4,8 mm roller		
				H	Small sim. roller lever, 17,9 mm [0.70 in] length, R 1,3 mm		
				J	Extended straight lever, 55,2 mm [2.17 in] length		
				K	Straight lever, 35,2 mm [1.39 in] length		
				L	L-shaped lever, 31,5 mm [1.24 in] length		
				M	Large sim. roller lever, 21,1 mm [0.83 in] length, R 2,45 mm		
				S	SPECIAL lever ²		

NOTES:

- ¹ Nomenclature is for identification purposes only; not all combinations of model code are available. Please contact your Honeywell representative or distributor for assistance.
- ² Terminal Type "99" or Actuator Type "S" designates a special and therefore requires a special designator character(s) at the end of the listing.
- ³ Switches with a 0.1 A, 3 A, or 6 A current rating may have an operating force choice of B (70 g max.), C (150 g max.), or D (95 g max.).
- ⁴ Switches with a 10.1 A current rating may only have an operating force of either "C" (150 g max.) or "G" (355 g max.).
- ⁵ Switches with a 16.1 A current rating may only have an operating force of "G" (355 g max.).
- ⁶ Gold-plated contacts only available with "15" and "55" current rating options.



MICRO SWITCH SUBMINIATURE BASIC SWITCHES

ZM & ZM1 SERIES

O.F. • Operating force
 R.F. • Release force
 P.T. • Pretravel
 O.T. • Overtravel
 D.T. • Differential travel
 O.P. • Operating position

TABLE 5. MICRO SWITCH ZM SERIES PRODUCT SPECIFICATIONS AND LISTINGS

Contact your Honeywell rep or distributor for additional listings

	Catalog Listing	Circuitry/ Contact Material	Elect. Rating (page 6)	Termination	Operate Force max. g [oz]	Release Force min. g [oz]	Free Position from mounting hole mm [in] max.
 Pin Plunger	ZM10B10A01	SPDT Gold Plated	0.1 A	Solder	60 [2.17]	8 [0.28]	9,3 [0.37]
	ZM10B70A01	SPDT Gold Plated	0.1 A	Long Solder	60 [2.17]	8 [0.28]	9,3 [0.37]
	ZM10D70A01	SPDT Gold Plated	0.1 A	Long Solder	104 [3.67]	20 [0.70]	9,3 [0.37]
	ZM10E10A01	SPDT Gold Plated	0.1 A	Solder	146 [5.15]	35 [1.23]	9,3 [0.37]
	ZM10E20A01	SPDT Gold Plated	0.1 A	PCB (Straight)	146 [5.15]	35 [1.23]	-
	ZM10E50A01	SPDT Gold Plated	0.1 A	PCB (90° Right)	146 [5.15]	35 [1.23]	-
	ZM10E70A01	SPDT Gold Plated	0.1 A	Long Solder	146 [5.15]	35 [1.23]	9,3 [0.37]
	ZM10E70A03	SPNO Gold Plated	0.1 A	Long Solder	146 [5.15]	35 [1.23]	9,3 [0.37]
	ZM50E10A01	SPDT Silver Alloy	5 A	Solder	146 [5.15]	35 [1.23]	9,3 [0.37]
	ZM50E10A03	SPNO Silver Alloy	5 A	Solder	146 [5.15]	35 [1.23]	9,3 [0.37]
	ZM50E20A01	SPDT Silver Alloy	5 A	PCB (Straight)	146 [5.15]	35 [1.23]	-
	ZM50E20A03	SPNO Silver Alloy	5 A	PCB (Straight)	146 [5.15]	35 [1.23]	-
	ZM50E50A01	SPDT Silver Alloy	5 A	PCB (90° Right)	146 [5.15]	35 [1.23]	-
	ZM50E70A01	SPDT Silver Alloy	5 A	Long Solder	146 [5.15]	35 [1.23]	9,3 [0.37]
	ZM50G20A01	SPDT Silver Alloy	5 A	PCB (Straight)	249 [8.78]	50 [1.76]	-
 Short Straight Lever (16,7 mm [0.66 in])	ZM90G10A01	SPDT Silver Alloy	10.1 A	Solder	249 [8.78]	50 [1.76]	9,3 [0.37]
	ZM90G20A01	SPDT Silver Alloy	10.1 A	PCB (Straight)	249 [8.78]	50 [1.76]	-
	ZM90G70A01	SPDT Silver Alloy	10.1 A	Long Solder	249 [8.78]	50 [1.76]	9,3 [0.37]
	ZM10E10B01	SPDT Gold Plated	0.1 A	Solder	40 [1.41]	6 [0.21]	11,7 [0.46]
	ZM10E50B01	SPDT Gold Plated	0.1 A	PCB (90° Right)	40 [1.41]	6 [0.21]	-
	ZM10G10B01	SPDT Gold Plated	0.1 A	Solder	66 [2.33]	9 [0.32]	11,7 [0.46]
	ZM50D10B01	SPDT Silver Alloy	5 A	Solder	30 [1.06]	3 [0.10]	11,7 [0.46]
	ZM50E10B01	SPDT Silver Alloy	5 A	Solder	40 [1.41]	6 [0.21]	11,7 [0.46]
	ZM50E20B01	SPDT Silver Alloy	5 A	PCB (Straight)	40 [1.41]	6 [0.21]	-
 Standard Straight Lever (18,7 mm [0.74 in])	ZM50E50B01	SPDT Silver Alloy	5 A	PCB (90° Right)	40 [1.41]	6 [0.21]	-
	ZM50E60B01	SPDT Silver Alloy	5 A	PCB (90° Left)	40 [1.41]	6 [0.21]	-
	ZM50E70B01	SPDT Silver Alloy	5 A	Long Solder	40 [1.41]	6 [0.21]	11,7 [0.46]
	ZM10B70C01	SPDT Gold Plated	0.1 A	Long Solder	14 [0.49]	2 [0.07]	12,0 [0.47]
	ZM10E10C01	SPDT Gold Plated	0.1 A	Solder	36 [1.27]	6 [0.21]	12,0 [0.47]
	ZM10E20C01	SPDT Gold Plated	0.1 A	PCB (Straight)	36 [1.27]	6 [0.21]	-
	ZM50E10C01	SPDT Silver Alloy	5 A	Solder	36 [1.27]	6 [0.21]	12,0 [0.47]
	ZM50E70C01	SPDT Silver Alloy	5 A	Long Solder	36 [1.27]	6 [0.21]	12,0 [0.47]

MICRO SWITCH SUBMINIATURE BASIC SWITCHES

ZM & ZM1 SERIES

O.F. • Operating force
 R.F. • Release force
 P.T. • Pretravel
 O.T. • Overtravel
 D.T. • Differential travel
 O.P. • Operating position

	Free Position max. mm [in] from base of straight PCB terminal*	Free Position from formed PCB terminal center line mm [in] max. *	Operate point from mounting hole mm [in]	Operate point from base of straight PCB terminal mm [in]*	Operate point from formed PCB terminal center line mm [in]*	P.T. max. mm [in]	O.T. min. mm [in]	D.T. max. mm [in]
-	-	-	8,5 ±0,3 [0.33 ±0.01]	-	-	1,1 [0.04]	0,4 [0.02]	0,2 [0.01]
-	-	-	8,5 ±0,3 [0.33 ±0.01]	-	-	1,1 [0.04]	0,4 [0.02]	0,2 [0.01]
-	-	-	8,5 ±0,3 [0.33 ±0.01]	-	-	1,1 [0.04]	0,4 [0.02]	0,2 [0.01]
-	-	-	8,5 ±0,3 [0.33 ±0.01]	-	-	1,1 [0.04]	0,4 [0.02]	0,2 [0.01]
12,7 [0.50]	-	-	-	11,9 ±0,3 [0.47 ±0.01]	-	1,1 [0.04]	0,4 [0.02]	0,2 [0.01]
-	14,0 [0.55]	-	-	-	13,2 ±0,3 [0.52 ±0.01]	1,1 [0.04]	0,4 [0.02]	0,2 [0.01]
-	-	-	8,5 ±0,3 [0.33 ±0.01]	-	-	1,1 [0.04]	0,4 [0.02]	0,2 [0.01]
-	-	-	8,5 ±0,3 [0.33 ±0.01]	-	-	1,1 [0.04]	0,4 [0.02]	0,2 [0.01]
-	-	-	8,5 ±0,3 [0.33 ±0.01]	-	-	1,1 [0.04]	0,4 [0.02]	0,2 [0.01]
-	-	-	8,5 ±0,3 [0.33 ±0.01]	-	-	1,1 [0.04]	0,4 [0.02]	0,2 [0.01]
12,7 [0.50]	-	-	-	11,9 ±0,3 [0.47 ±0.01]	-	1,1 [0.04]	0,4 [0.02]	0,2 [0.01]
12,7 [0.50]	-	-	-	11,9 ±0,3 [0.47 ±0.01]	-	1,1 [0.04]	0,4 [0.02]	0,2 [0.01]
-	14,0 [0.55]	-	-	-	13,2 ±0,3 [0.52 ±0.01]	1,1 [0.04]	0,4 [0.02]	0,2 [0.01]
-	-	-	8,5 ±0,3 [0.33 ±0.01]	-	-	1,1 [0.04]	0,4 [0.02]	0,2 [0.01]
12,7 [0.50]	-	-	-	11,9 ±0,3 [0.47 ±0.01]	-	1,1 [0.04]	0,4 [0.02]	0,2 [0.01]
-	-	-	8,5 ±0,3 [0.33 ±0.01]	-	-	1,1 [0.04]	0,4 [0.02]	0,2 [0.01]
12,7 [0.50]	-	-	-	11,9 ±0,3 [0.47 ±0.01]	-	1,1 [0.04]	0,4 [0.02]	0,2 [0.01]
-	-	-	8,5 ±0,3 [0.33 ±0.01]	-	-	1,1 [0.04]	0,4 [0.02]	0,2 [0.01]
-	-	-	8,9 ±0,8 [0.35 ±0.03]	-	-	3,6 [0.14]	0,6 [0.02]	0,8 [0.03]
-	16,4 [0.65]	-	-	-	13,6 ±0,8 [0.54 ±0.03]	3,6 [0.14]	0,6 [0.02]	0,8 [0.03]
-	-	-	8,9 ±0,8 [0.35 ±0.03]	-	-	3,6 [0.14]	0,6 [0.02]	0,8 [0.03]
-	-	-	8,9 ±0,8 [0.35 ±0.03]	-	-	3,6 [0.14]	0,6 [0.02]	0,8 [0.03]
-	-	-	8,9 ±0,8 [0.35 ±0.03]	-	-	3,6 [0.14]	0,6 [0.02]	0,8 [0.03]
15,1 [0.59]	-	-	-	12,3 ±0,8 [0.48 ±0.03]	-	3,6 [0.14]	0,6 [0.02]	0,8 [0.03]
-	16,4 [0.65]	-	-	-	13,6 ±0,8 [0.54 ±0.03]	3,6 [0.14]	0,6 [0.02]	0,8 [0.03]
-	16,4 [0.65]	-	-	-	13,6 ±0,8 [0.54 ±0.03]	3,6 [0.14]	0,6 [0.02]	0,8 [0.03]
-	-	-	8,9 ±0,8 [0.35 ±0.03]	-	-	3,6 [0.14]	0,6 [0.02]	0,8 [0.03]
-	-	-	8,9 ±0,9 [0.35 ±0.04]	-	-	4,0 [0.16]	0,6 [0.02]	0,8 [0.03]
-	-	-	8,9 ±0,9 [0.35 ±0.04]	-	-	4,0 [0.16]	0,6 [0.02]	0,8 [0.03]
15,4 [0.61]	-	-	-	12,3 ±0,9 [0.48 ±0.04]	-	4,0 [0.16]	0,6 [0.02]	0,8 [0.03]
-	-	-	8,9 ±0,9 [0.35 ±0.04]	-	-	4,0 [0.16]	0,6 [0.02]	0,8 [0.03]
-	-	-	8,9 ±0,9 [0.35 ±0.04]	-	-	4,0 [0.16]	0,6 [0.02]	0,8 [0.03]

* See asterisk on page 16 for dimension locations.

MICRO SWITCH SUBMINIATURE BASIC SWITCHES

ZM & ZM1 SERIES

O.F. • Operating force
 R.F. • Release force
 P.T. • Pretravel
 O.T. • Overtravel
 D.T. • Differential travel
 O.P. • Operating position

TABLE 5. MICRO SWITCH ZM SERIES PRODUCT SPECIFICATIONS AND LISTINGS

Contact your Honeywell rep or distributor for additional listings

	Catalog Listing	Circuitry/ Contact Material	Elect. Rating (page 6)	Termination	Operate Force max. g [oz]	Release Force min. g [oz]	Free Position from mounting hole mm [in] max.
 Long Straight Lever (24,8 mm [0.98 in])	ZM10B10D01	SPDT Gold Plated	0.1 A	Solder	13 [0.46]	2 [0.07]	13,5 [0.53]
	ZM10B70D01	SPDT Gold Plated	0.1 A	Long Solder	13 [0.46]	2 [0.07]	13,5 [0.53]
	ZM10D10D01	SPDT Gold Plated	0.1 A	Solder	20 [0.70]	5 [0.18]	13,5 [0.53]
	ZM10D20D01	SPDT Gold Plated	0.1 A	PCB (Straight)	20 [0.70]	5 [0.18]	-
	ZM10E70D01	SPDT Gold Plated	0.1 A	Long Solder	28 [0.99]	4 [0.14]	13,5 [0.53]
	ZM50E10D01	SPDT Silver Alloy	5 A	Solder	28 [0.99]	4 [0.14]	13,5 [0.53]
	ZM50E50D01	SPDT Silver Alloy	5 A	PCB (90° Right)	28 [0.99]	4 [0.14]	-
	ZM50E70D01	SPDT Silver Alloy	5 A	Long Solder	28 [0.99]	4 [0.14]	13,5 [0.53]
 Extended Straight Lever (55,2 mm [2.17 in])	ZM50E70J01	SPDT Silver Alloy	5 A	Long Solder	12 [0.42]	2,5 [0.09]	19,2 [0.76]
 Small Simu- lated Roller Lever (17,9 mm [0.70 in])	ZM10E20H01	SPDT Gold Plated	0.1 A	PCB (Straight)	34 [1.20]	8 [0.28]	-
	ZM50G10H01	SPDT Silver Alloy	5 A	Solder	56 [1.98]	13 [0.46]	14,4 [0.57]
 Standard Simulated Roller Lever (18 mm [0.71 in])	ZM10B70E01	SPDT Gold Plated	0.1 A	Long Solder	14 [0.49]	2 [0.07]	18,9 [0.74]
	ZM10D10E01	SPDT Gold Plated	0.1 A	Solder	26 [0.92]	5 [0.18]	18,9 [0.74]
	ZM10D70E01	SPDT Gold Plated	0.1 A	Long Solder	26 [0.92]	5 [0.18]	18,9 [0.74]
	ZM10E10E01	SPDT Gold Plated	0.1 A	Solder	35 [1.23]	8 [0.28]	18,9 [0.74]
	ZM10E50E01	SPDT Gold Plated	0.1 A	PCB (90° Right)	35 [1.23]	8 [0.28]	-
	ZM50E10E01	SPDT Silver Alloy	5 A	Solder	35 [1.23]	8 [0.28]	18,9 [0.74]
	ZM50E20E01	SPDT Silver Alloy	5 A	PCB (Straight)	35 [1.23]	8 [0.28]	-
	ZM50E70E01	SPDT Silver Alloy	5 A	Long Solder	35 [1.23]	8 [0.28]	18,9 [0.74]

MICRO SWITCH SUBMINIATURE BASIC SWITCHES

ZM & ZM1 SERIES

O.F. • Operating force
R.F. • Release force
P.T. • Pretravel
O.T. • Overtravel
D.T. • Differential travel
O.P. • Operating position

	Free Position max. mm [in] from base of straight PCB terminal*	Free Position from formed PCB terminal center line mm [in] max. *	Operate point from mounting hole mm [in]	Operate point from base of straight PCB terminal mm [in]*	Operate point from formed PCB terminal center line mm [in]*	P.T. max. mm [in]	O.T. min. mm [in]	D.T. max. mm [in]
	-	-	8,9 ±1,5 [0.35 ±0.06]	-	-	6,1 [0.24]	0,8 [0.03]	1,5 [0.06]
	-	-	8,9 ±1,5 [0.35 ±0.06]	-	-	6,1 [0.24]	0,8 [0.03]	1,5 [0.06]
	-	-	8,9 ±1,5 [0.35 ±0.06]	-	-	6,1 [0.24]	0,8 [0.03]	1,5 [0.06]
	16,9 [0.67]	-	-	12,3 ±1,5 [0.48 ±0.06]	-	6,1 [0.24]	0,8 [0.03]	1,5 [0.06]
	-	-	8,9 ±1,5 [0.35 ±0.06]	-	-	6,1 [0.24]	0,8 [0.03]	1,5 [0.06]
	-	-	8,9 ±1,5 [0.35 ±0.06]	-	-	6,1 [0.24]	0,8 [0.03]	1,5 [0.06]
	-	18,2 [0.72]	-	-	13,6 ±1,5 [0.54 ±0.06]	6,1 [0.24]	0,8 [0.03]	1,5 [0.06]
	-	-	8,9 ±1,5 [0.35 ±0.06]	-	-	6,1 [0.24]	0,8 [0.03]	1,5 [0.06]
	-	-	8,9 ±3,0 [0.35 ±0.12]	-	-	13,3 [0.52]	1,0 [0.04]	2,9 [0.11]
	17,8 [0.70]	-	-	14,2 ±1,0 [0.56 ±0.04]	-	4,6 [0.18]	0,8 [0.03]	0,8 [0.03]
	-	-	10,8 ±1,0 [0.43±0.04]	-	-	4,6 [0.18]	0,8 [0.03]	0,8 [0.03]
	-	-	12,2 ±1,5 [0.48 ±0.06]	-	-	5,2 [0.20]	0,6 [0.02]	0,9 [0.04]
	-	-	12,2 ±1,5 [0.48 ±0.06]	-	-	5,2 [0.20]	0,6 [0.02]	0,9 [0.04]
	-	-	12,2 ±1,5 [0.48 ±0.06]	-	-	5,2 [0.20]	0,6 [0.02]	0,9 [0.04]
	-	-	12,2 ±1,5 [0.48 ±0.06]	-	-	5,2 [0.20]	0,6 [0.02]	0,9 [0.04]
	-	23,6 [0.93]	-	-	16,9 ±1,5 [0.66 ±0.06]	5,2 [0.20]	0,6 [0.02]	0,9 [0.04]
	-	-	12,2 ±1,5 [0.48 ±0.06]	-	-	5,2 [0.20]	0,6 [0.02]	0,9 [0.04]
	22,3 [0.88]	-	-	15,6 ±1,5 [0.61 ±0.06]	-	5,2 [0.20]	0,6 [0.02]	0,9 [0.04]
	-	-	12,2 ±1,5 [0.48 ±0.06]	-	-	5,2 [0.20]	0,6 [0.02]	0,9 [0.04]

* See asterisk on page 16 for dimension locations.

MICRO SWITCH SUBMINIATURE BASIC SWITCHES

ZM & ZM1 SERIES

O.F. • Operating force
 R.F. • Release force
 P.T. • Pretravel
 O.T. • Overtravel
 D.T. • Differential travel
 O.P. • Operating position

TABLE 5. MICRO SWITCH ZM SERIES PRODUCT SPECIFICATIONS AND LISTINGS

Contact your Honeywell rep or distributor for additional listings

	Catalog Listing	Circuitry/ Contact Material	Elect. Rating (page 6)	Termination	Operate Force max. g [oz]	Release Force min. g [oz]	Free Position from mounting hole mm [in] max.
 Roller Lever (16,6 mm [0.65 in])	ZM10B70F01	SPDT Gold Plated	0.1 A	Long Solder	19 [0.67]	2 [0.07]	17,6 [0.69]
	ZM10E10F01	SPDT Gold Plated	0.1 A	Solder	34 [1.23]	8 [0.28]	17,6 [0.69]
	ZM10E50F01	SPDT Gold Plated	0.1 A	PCB (90° Right)	34 [1.23]	8 [0.28]	-
	ZM50D10F01	SPDT Silver Alloy	5 A	Solder	25 [0.88]	6 [0.21]	17,6 [0.69]
	ZM50E10F01	SPDT Silver Alloy	5 A	Solder	34 [1.23]	8 [0.28]	17,6 [0.69]
	ZM50E50F01	SPDT Silver Alloy	5 A	PCB (90° Right)	34 [1.23]	8 [0.28]	-
	ZM50E70F01	SPDT Silver Alloy	5 A	Long Solder	34 [1.23]	8 [0.28]	17,6 [0.69]
	ZM90G20F01	SPDT Silver Alloy	10.1 A	PCB (Straight)	60 [2.17]	15 [0.53]	-
 L-Shaped Lever (31,5 mm [1.24 in])	ZM50E10L01	SPDT Silver Alloy	5 A	Solder	20 [0.71]	4 [0.14]	2,5 [0.10]

MICRO SWITCH SUBMINIATURE BASIC SWITCHES

ZM & ZM1 SERIES

O.F. • Operating force
 R.F. • Release force
 P.T. • Pretravel
 O.T. • Overtravel
 D.T. • Differential travel
 O.P. • Operating position

	Free Position max. mm [in] from base of straight PCB terminal*	Free Position from formed PCB terminal center line mm [in] max. *	Operate point from mounting hole mm [in]	Operate point from base of straight PCB terminal mm [in]*	Operate point from formed PCB terminal center line mm [in]*	P.T. max. mm [in]	O.T. min. mm [in]	D.T. max. mm [in]
	-	-	14,6 ±0,8 [0.57 ±0.03]	-	-	3,8 [0.15]	0,8 [0.03]	0,8 [0.03]
	-	-	14,6 ±0,8 [0.57 ±0.03]	-	-	3,8 [0.15]	0,8 [0.03]	0,8 [0.03]
	-	22,3 [0.88]	-	-	19,3 ±0,8 [0.76 ±0.03]	3,8 [0.15]	0,8 [0.03]	0,8 [0.03]
	-	-	14,6 ±0,8 [0.57 ±0.03]	-	-	3,8 [0.15]	0,8 [0.03]	0,8 [0.03]
	-	-	14,6 ±0,8 [0.57 ±0.03]	-	-	3,8 [0.15]	0,8 [0.03]	0,8 [0.03]
	-	22,3 [0.88]	-	-	19,3 ±0,8 [0.76 ±0.03]	3,8 [0.15]	0,8 [0.03]	0,8 [0.03]
	-	-	14,6 ±0,8 [0.57 ±0.03]	-	-	3,8 [0.15]	0,8 [0.03]	0,8 [0.03]
	21,0 [0.83]	-	-	18,0 ±0,8 [0.71 ±0.03]	-	3,8 [0.15]	0,8 [0.03]	0,8 [0.03]
	-	-	-5,2 ± 3,0 [-0.20 ±0.12]	-	-	6,0 [0.24]	1,0 [0.04]	1,9 [0.07]

* See asterisk on page 16 for dimension locations.

MICRO SWITCH SUBMINIATURE BASIC SWITCHES

ZM & ZM1 SERIES

O.F. • Operating force
 R.F. • Release force
 P.T. • Pretravel
 O.T. • Overtravel
 D.T. • Differential travel
 O.P. • Operating position

Table 6. MICRO SWITCH™ ZM1 Series Product Specifications and Listings

Contact your Honeywell rep or distributor for additional listings

TABLE 6. MICRO SWITCH ZM1 SERIES PRODUCT SPECIFICATIONS AND LISTINGS

Contact your Honeywell rep or distributor for additional listings

	Catalog Listing	Circuitry/ Contact Material	Elect. Rating (page 7)	Termination	Operate Force max. g [oz]	Release Force min. g [oz]	
 Pin Plunger	ZM110B70A01	SPDT Silver Alloy	0.1 A	Long Solder	70 [2.47]	5 [0.18]	
	ZM160C70A01	SPDT Silver Alloy	6 A	Long Solder	150 [5.29]	25 [0.88]	
	ZM190C60A01	SPDT Silver Alloy	10.1 A	PCB (90° Left)	150 [5.29]	25 [0.88]	
	ZM195G10A03	SPNO Silver Alloy	16.1 A	Solder	355 [12.52]	100 [3.53]	
 Short Straight Lever (16,7 mm [0.66 in])	ZM190C10B01	SPDT Silver Alloy	10.1 A	Solder	50 [1.76]	6 [0.21]	
	ZM195G10B04	SPNC Silver Alloy	16.1 A	Solder	118 [4.16]	20 [0.71]	
 Standard Straight Lever (18,7 mm [0.74 in])	ZM115C70C01-G	SPDT Gold Plated	0.1 A	Long Solder	45 [1.59]	5 [0.18]	
	ZM150C70C01	SPDT Silver Alloy	3 A	Long Solder	45 [1.59]	5 [0.18]	
	ZM190C10C01	SPDT Silver Alloy	10.1 A	Solder	45 [1.59]	5 [0.18]	
 Standard Simulated Roller Lever (18 mm [0.71 in])	ZM160C10E01	SPDT Silver Alloy	6 A	Solder	42 [1.48]	6 [0.21]	

MICRO SWITCH SUBMINIATURE BASIC SWITCHES

ZM & ZM1 SERIES

O.F. • Operating force
 R.F. • Release force
 P.T. • Pretravel
 O.T. • Overtravel
 D.T. • Differential travel
 O.P. • Operating position

	Free Position from mounting hole mm [in] max.	Free Position from formed PCB terminal center line mm [in] max. *	Operate point from mounting hole mm [in]	Operate point from formed PCB terminal center line mm [in]*	P.T. max. mm [in]	O.T. min. mm [in]	D.T. max. mm [in]
	9,4 [0.37]	-	8,6 ±0,3 [0.34 ± 0.01]	-	1,1 [0.04]	0,4 [0.02]	0,2 [0.01]
	9,4 [0.37]	-	8,6 ±0,3 [0.34 ± 0.01]	-	1,1 [0.04]	0,4 [0.02]	0,2 [0.01]
	-	14,0 [0.55]	-	13,2 ±0,3 [0.52 ±0.01]	1,1 [0.04]	0,4 [0.02]	0,2 [0.01]
	9,4 [0.37]	-	8,6 ±0,3 [0.34 ± 0.01]	-	1,1 [0.04]	0,4 [0.02]	0,2 [0.01]
	11,8 [0.46]	-	9,0 ±0,8 [0.35 ±0.03]	-	3,6 [0.14]	0,6 [0.02]	0,8 [0.03]
	11,8 [0.46]	-	8,6 ±1,3 [0.34 ±0.05]	-	4,6 [0.18]	0,5 [0.02]	1,5 [0.06]
	12,1 [0.48]	-	9,0 ±0,9 [0.35 ±0.04]	-	4,0 [0.16]	0,7 [0.03]	0,9 [0.04]
	12,1 [0.48]	-	9,0 ±0,9 [0.35 ±0.04]	-	4,0 [0.16]	0,7 [0.03]	0,9 [0.04]
	12,1 [0.48]	-	9,0 ±0,9 [0.35 ±0.04]	-	4,0 [0.16]	0,7 [0.03]	0,9 [0.04]
	16,0 [0.63]	-	12,3 ±1,5 [0.48 ±0.06]	-	5,2 [0.20]	0,6 [0.02]	0,9 [0.04]

* See asterisk on page 17 for dimension locations.

MICRO SWITCH SUBMINIATURE BASIC SWITCHES ZM & ZM1 SERIES

MICRO SWITCH ZM SERIES MOUNTING DIMENSIONS

General Mounting Dimensions

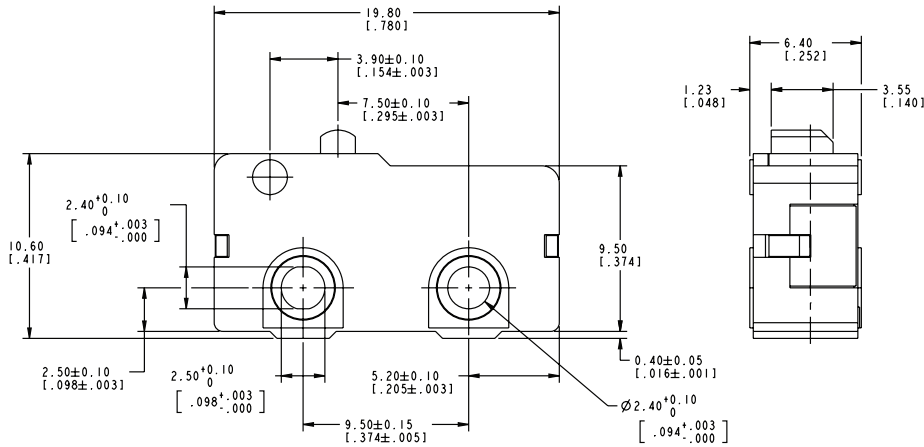

Terminal Type 10 - Standard Solder

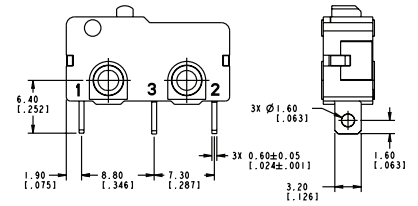

Terminal Type 20 - Straight PCB

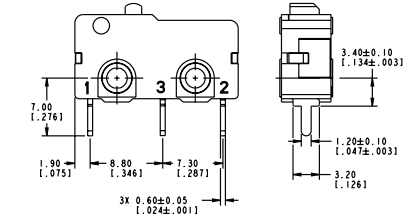

Terminal Type 50 - Right PCB

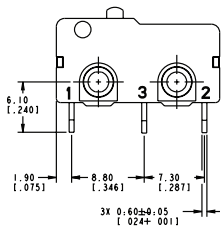

Terminal Type 60 - Left PCB

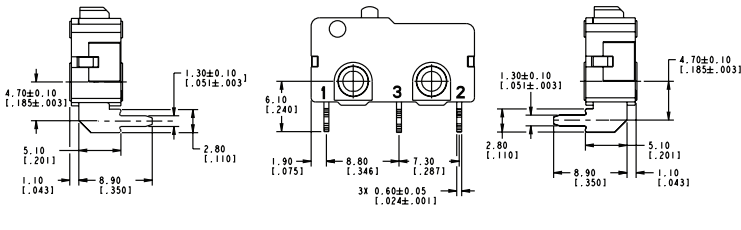

Terminal Type 70 - Long Solder

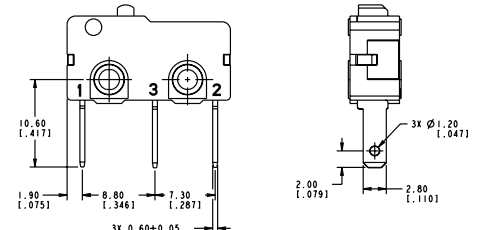

Actuator Types: All actuators except Type A and F are 4,05 mm ±0,05 mm wide

Type A

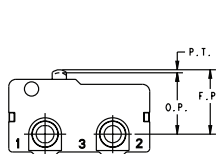

Type B

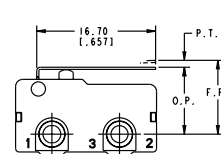

Type C

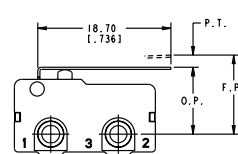

Type D

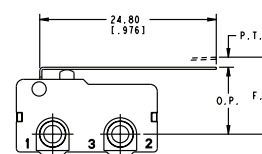

Type E

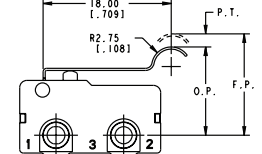

Type F

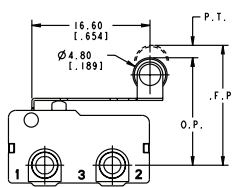

Type H

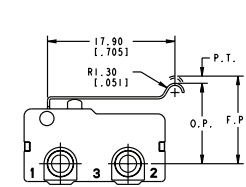

Type J

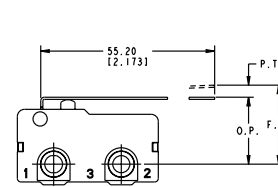

Type K

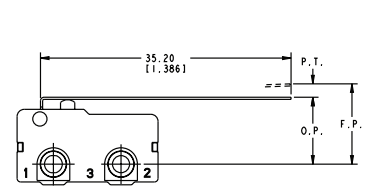

Type L

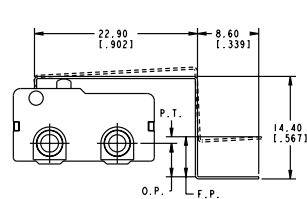

Type M

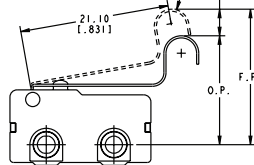

Operate Point References for PCB Terminals

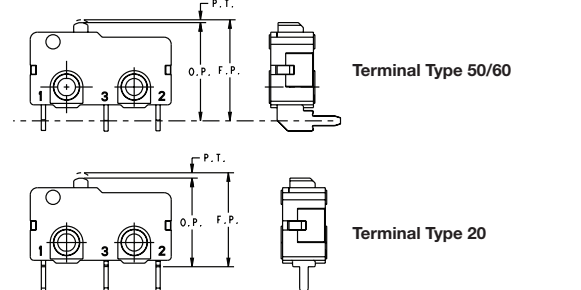

MICRO SWITCH SUBMINIATURE BASIC SWITCHES ZM & ZM1 SERIES

MICRO SWITCH ZM1 SERIES MOUNTING DIMENSIONS

General Mounting Dimensions

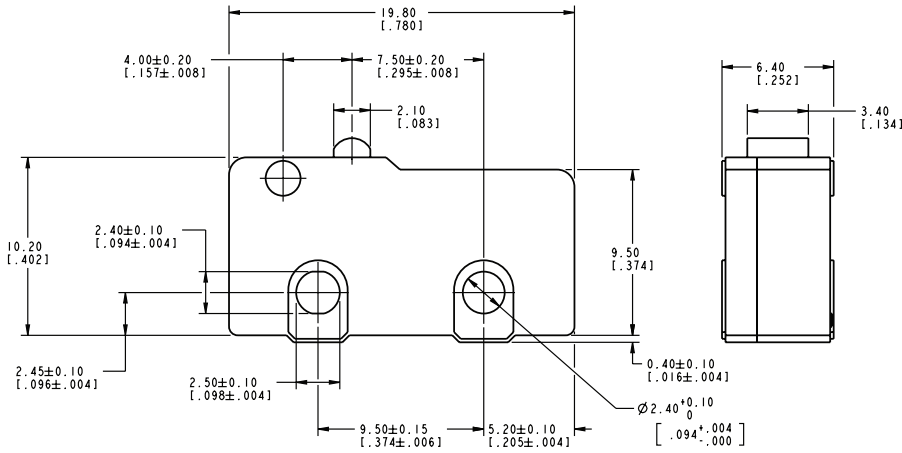

Terminal Type 10 - Standard Solder

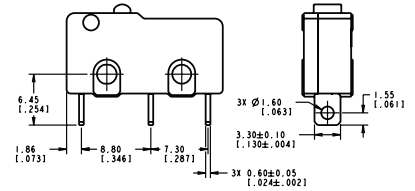

Terminal Type 20 - Straight PCB

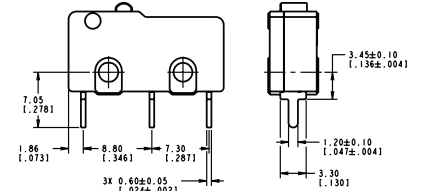

Terminal Type 50 - Right PCB

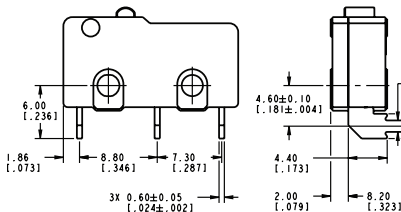

Terminal Type 60 - Left PCB

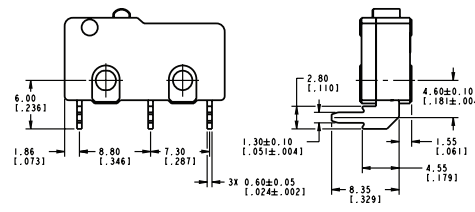

Terminal Type 70 - Long Solder

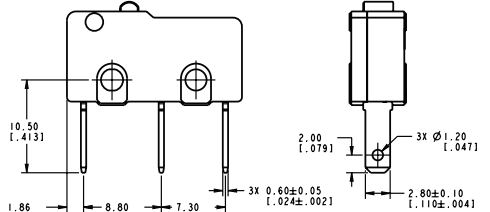

Actuator Types: All actuators except Type A and F are 4,05 mm ±0,05 mm wide

Type A

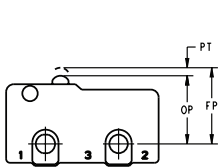

Type B

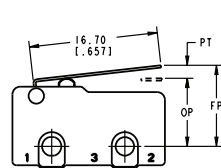

Type C

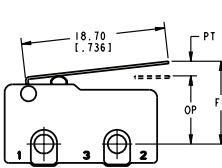

Type D

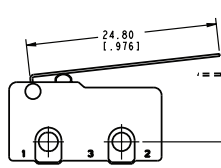

Type E

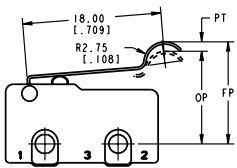

Type F

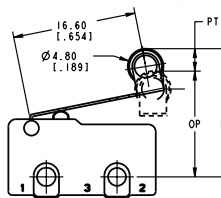

Type H

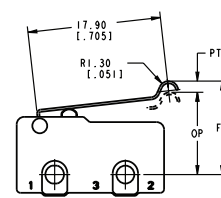

Type J

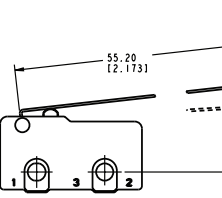

Type K

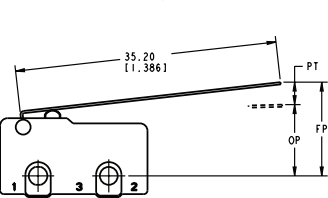

Type L

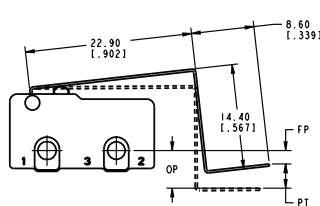

Type M

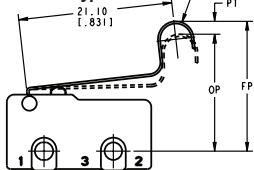

Operate Point References for PCB Terminals

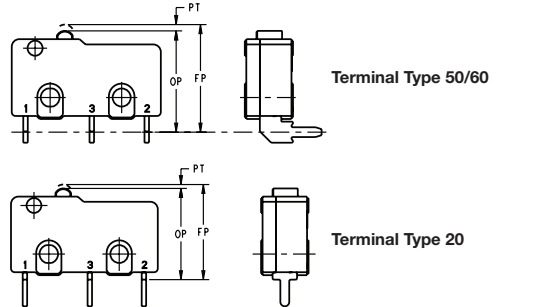

ADDITIONAL INFORMATION

The following associated literature is available on the Honeywell web site at sps.honeywell.com/ast:

- Product installation instructions
- Product range guide
- Product nomenclature tree
- Product application-specific information
 - Application note: Sensors and switches for potential HVAC/R applications
 - Application note: Sensors and switches for potential medical applications
 - Technical bulletin: Applying precision switches
 - Technical bulletin: Low energy switch guide

WARRANTY/REMEDY

Honeywell warrants goods of its manufacture as being free of defective materials and faulty workmanship during the applicable warranty period. Honeywell's standard product warranty applies unless agreed to otherwise by Honeywell in writing; please refer to your order acknowledgment or consult your local sales office for specific warranty details. If warranted goods are returned to Honeywell during the period of coverage, Honeywell will repair or replace, at its option, without charge those items that Honeywell, in its sole discretion, finds defective. The foregoing is buyer's sole remedy and is in lieu of all other warranties, expressed or implied, including those of merchantability and fitness for a particular purpose. In no event shall Honeywell be liable for consequential, special, or indirect damages.

While Honeywell may provide application assistance personally, through our literature and the Honeywell web site, it is buyer's sole responsibility to determine the suitability of the product in the application.

Specifications may change without notice. The information we supply is believed to be accurate and reliable as of this writing. However, Honeywell assumes no responsibility for its use.

WARNING MISUSE OF DOCUMENTATION

- The information presented in this product sheet is for reference only. Do not use this document as a product installation guide.
- Complete installation, operation, and maintenance information is provided in the instructions supplied with each product.

Failure to comply with these instructions could result in death or serious injury.

FOR MORE INFORMATION

Honeywell Advanced Sensing Technologies services its customers through a worldwide network of sales offices and distributors. For application assistance, current specifications, pricing or the nearest Authorized Distributor, visit [our website](#) or call:

USA/Canada	+1 302 613 4491
Latin America	+1 305 805 8188
Europe	+44 1344 238258
Japan	+81 (0) 3-6730-7152
Singapore	+65 6355 2828
Greater China	+86 4006396841

Honeywell
Advanced Sensing Technologies
830 East Arapaho Road
Richardson, TX 75081
www.honeywell.com