

FEATURES

- Industry-standard through-hole eighth-brick package
- Wide input range of 18-75Vdc or 9-36Vdc (12Vout only)
- Fixed outputs from 3.3, 5 and 12 Volts DC up to 120 Watts
- Synchronous rectification yields very high efficiency and low power dissipation
- Operating temperature range from -40°C to +85°C with derating
- Up to 2250 Volt DC isolation
- Outstanding thermal performance and derating
- Extensive self-protection, over temperature and overload features
- On/Off control, trim and remote sense functions
- Certified to UL/IEC 60950-1, CAN/CSA-C22.2 No. 60950-1, 2nd Edition, safety approvals and EN55022/CISPR22 standards; IEC62368
- Pre-bias operation for startup protection

PRODUCT OVERVIEW

The UWE series open frame DC-DC converters deliver up to 120 Watts in an industry-standard "eighth-brick" through-hole package. This format can plug directly into quarter-brick pin outs. Several standard fixed-output voltages from 3.3 Vdc to 12 Vdc assure compatibility in embedded equipment, CPU cards and instrument subsystems. The extended 4-to-1 input voltage range is ideal for battery-powered, telecom or portable applications. Very high efficiency means no fans or temperature deratings in many applications. An optional baseplate extends operation into most conceivable environments.

The synchronous rectifier design uses the maximum available duty cycle for greatest efficiency and low power dissipation. These devices deliver low output noise, tight line/load regulation, stable no-load operation and fast load step response. All

units are precision assembled in a highly automated facility with ISO-traceable manufacturing quality standards. Isolation of 2250 Volts assures safety and fully differential (floating) operation for greatest application flexibility. On-board Sense terminals compensate for load line voltage errors at high output currents. Outputs are trimmable within $\pm 10\%$ of nominal voltage.

A wealth of protection features prevents damage to both the converter and outside circuits. Inputs are protected from under voltage and outputs feature short circuit protection, over current and over temperature shut down. Overloads automatically recover using the "hiccup" technique upon fault removal. The UWE is certified to standard safety and EMI/RFI approvals. All units meet RoHS-6 hazardous materials compliance.

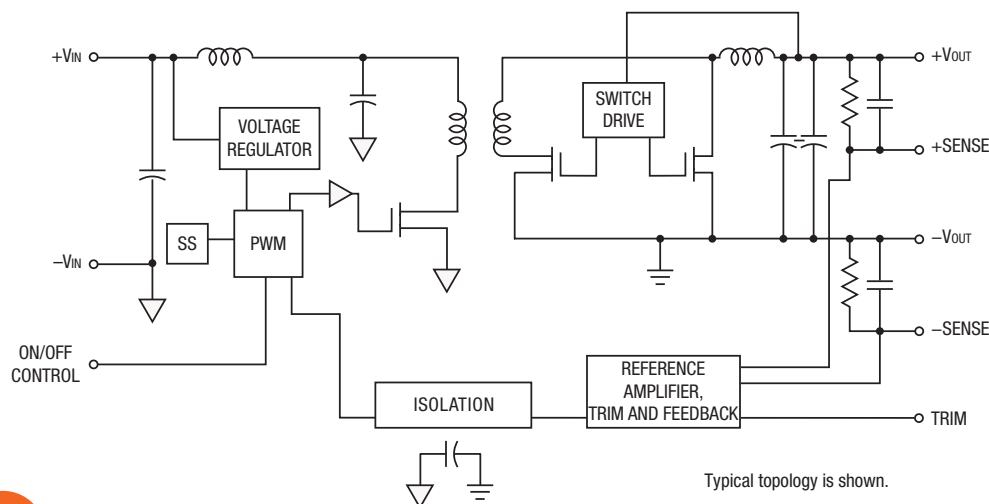

Figure 1. Simplified Block Diagram



SPECIFICATION SUMMARY AND ORDERING GUIDE ①②③															
Root Model ①	Output						Input				Efficiency		Dimensions		
	V _{OUT} (V) ④	I _{OUT} (A)	Power (W)	R/N (mVp-p)		Regulation (%)		V _{IN} Nom. (V)	Range (V)	I _{IN} , min load (mA)	I _{IN} , full load (A)	Min.	Typ.	Case (Inches)	Case (mm)
				Typ.	Max.	Line	Load								
UWE-3.3/30-Q48-C	3.3	30	99	90	125	±0.2	±0.2	48	18-75	90	2.30	88%	89.5%	2.3x0.9x0.39	58.42x22.86x9.91
UWE-5/20-Q48-C	5	20	100	75	110	±0.1	±0.2	48	18-75	100	2.30	89%	90.5%	2.3x0.9x0.39	58.42x22.86x9.91
UWE-12/10-Q48-C	12	10	120	115	200	±0.15	±0.075	48	18-75	110	2.732	90%	91.5%	2.3x0.9x0.39	58.42x22.86x9.91
UWE-12/10-Q12-C ⑤	12	10	120	115	200	±0.15	±0.075	12	9-36	260	10.95	89.5%	91.3%	2.3x0.9x0.34	58.42x22.86x8.64

- ① Please refer to the part number structure for additional ordering model numbers and options.
- ② All specifications are typical at nominal line voltage, nominal output voltage and full load, +25°C unless otherwise noted. See detailed specifications.
- ③ External capacitors used for testing: with appropriate voltage and current ratings, output capacitors are 1 µF in parallel with 10 µF. Input cap is 33 µF. All caps are low ESR types. Contact Murata Power Solutions for details.

- ④ I/O caps are necessary for our test equipment. The values and number of capacitors may be modified depending on the application.
- ⑤ This product has been replaced with a new and improved version. Please see the UWE-Q12 Series datasheet for product information. Please click [here](#) to view the product datasheet. Please click [here](#) to view the Product Change Notification.

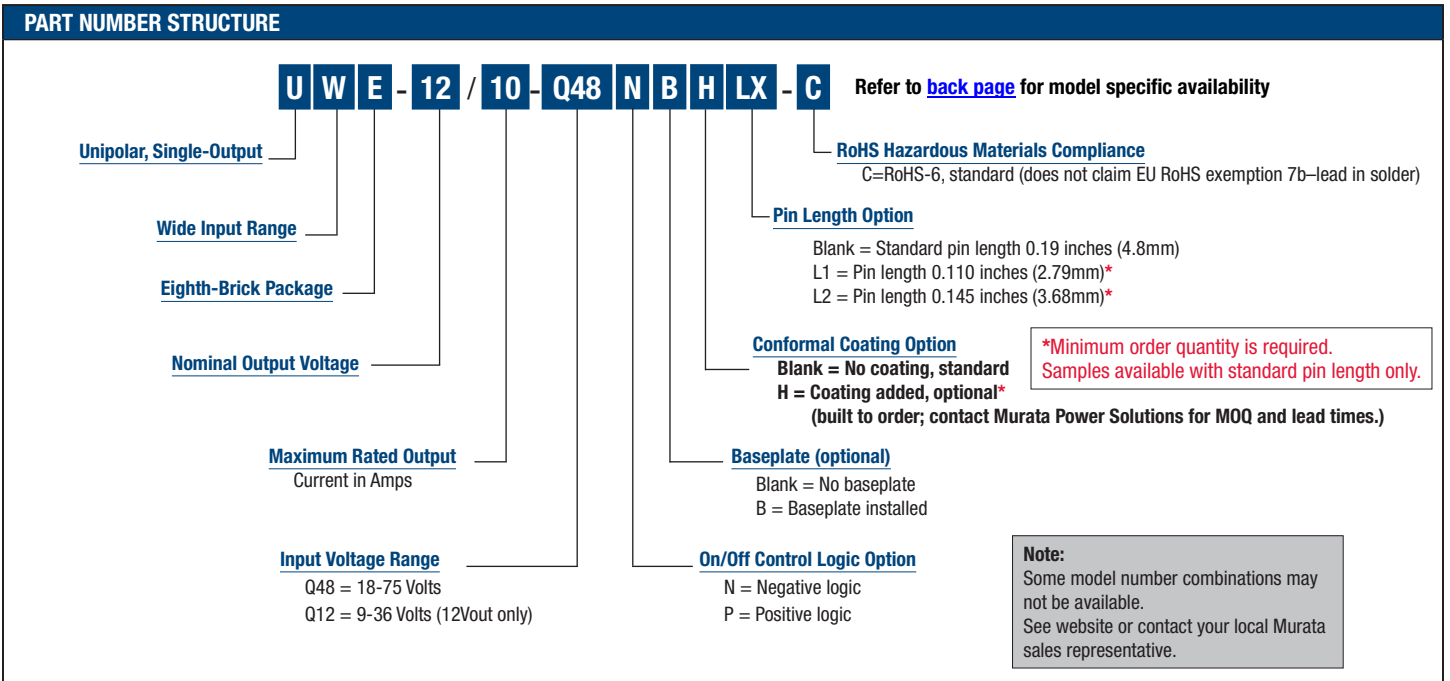

Customer Configured Part Numbers:
 1. UWE-31311-C (special version of the UWE-12/10-Q48NB-C)
 a. Includes conformal coating
 b. Isolation tested to 2,828Vdc Input-to-Output per IEEE 1613
 c. Pin length of 0.180 inches ±0.02 (4.6mm ±0.508)

NOTE: Please see the Product Status Chart on Page 35.

FUNCTIONAL SPECIFICATIONS, UWE-3.3/30-Q48

ABSOLUTE MAXIMUM RATINGS	CONDITIONS AND COMMENTS ①	MINIMUM	TYPICAL/NOMINAL	MAXIMUM	UNITS
Input Voltage, Continuous	Full power operation			80	Vdc
Input Voltage, Transient	Operating or non-operating, 100 mS max. duration			100	Vdc
Isolation Voltage	Input to output			2250	Vdc
Input Reverse Polarity	None, install external fuse		None		Vdc
On/Off Remote Control	Power on or off, referred to -Vin	0		15	Vdc
Output Power		0		99.99	W
Output Current	Current-limited, no damage, short-circuit protected	0		30	A
Storage Temperature Range	Vin = Zero (no power)	-55		125	°C
Absolute maximums are stress ratings. Exposure of devices to greater than any of these conditions may adversely affect long-term reliability. Proper operation under conditions other than those listed in the Performance/Functional Specifications Table is not implied or recommended.					
INPUT	CONDITIONS AND COMMENTS ① ③				
Operating voltage range		18	48	75	Vdc
Recommended External Fuse	Fast blow			12	A
Start-up threshold, Turn On	Rising input voltage	16.5	17	17.9	Vdc
Undervoltage shutdown, Turn Off	Falling input voltage	15.5	16.5	17.5	Vdc
Turn-On/Turn-Off Hysteresis		0.86	1.05	1.25	Vdc
Overvoltage shutdown			NA		Vdc
Reverse Polarity Protection	None, install external fuse		None		Vdc
Internal Filter Type			Pi-type		
Input current					
Full Load Conditions	Vin = nominal		2.304	2.367	A
Low Line	Vin = minimum		6.145	6.349	A
Inrush Transient			0.1		A ² -Sec.
Short Circuit Input Current			150	200	mA
No Load Input Current	Iout = minimum, unit=ON		90	125	mA
Standby Mode Input Current (Off, UV, OT)			4	8	mA
Reflected (back) ripple current ②	no filtering		500	700	mA, P-P
Reflected (back) ripple current ②	Measured at input with specified filter		50	70	mA, P-P
Pre-biased startup	Monotonic				
GENERAL AND SAFETY					
Efficiency	Vin=24V, full load	89	90		%
	Vin=min. to max.	87.5	89		%
	Vin=48V, full load	88	89.5		%
Isolation					
Isolation Voltage, input to output	No baseplate	2250			Vdc
Isolation Voltage, input to output	With baseplate	2250			Vdc
Isolation Voltage, input to baseplate	With baseplate	1500			Vdc
Isolation Voltage, output to baseplate	With baseplate	750			Vdc
Insulation Safety Rating			basic		
Isolation Resistance			100		MΩ
Isolation Capacitance			1000		pF
Safety	Certified to UL-60950-1, CSA-C22.2 No.60950-1, IEC60950-1, 2nd edition; IEC62368		Yes		
Calculated MTBF	Per Telcordia SR332, issue 1, class 3, ground fixed, Tambient=+40C		TBD		Hours x 10 ³
DYNAMIC CHARACTERISTICS					
Fixed Switching Frequency		195	215	235	KHz
Startup Time	Power on, Vout regulated		20	30	mS
Startup Time	Remote ON to Vout regulated		10	20	mS
Dynamic Load Response	50-75-50% load step, settling time to within 2% of Vout.		50	200	μSec
Dynamic Load Peak Deviation	same as above		±500		mV
FEATURES AND OPTIONS					
Remote On/Off Control ④					
"N" suffix:					
Negative Logic, ON state	ON = Pin grounded or external voltage	0		1	V
Negative Logic, OFF state	OFF = Pin open or external voltage	3.5		15	V
Control Current	open collector/drain		1	2	mA
"P" suffix:					
Positive Logic, ON state	ON = Pin open or external voltage	3.5		15	V
Positive Logic, OFF state	OFF = Ground pin or external voltage	0		0.8	V
Control Current	open collector/drain		1	2	mA
Base Plate	"B" suffix				

FUNCTIONAL SPECIFICATIONS, UWE-3.3/30-Q48 (CONT.)

OUTPUT					
Total Output Power		0	99	99.99	W
Voltage					
Nominal Output Voltage	No trim	3.267	3.3	3.333	Vdc
Settling Accuracy	At 50% load	-1		1	% of Vset.
Output Voltage Range	User-adjustable (see trim formulas)	-10		10	% of Vnom.
Overvoltage Protection	Via magnetic feedback		3.8	4.5	Vdc
Current					
Output Current Range		0	30	30	A
Minimum Load	No minimum load				
Current Limit Inception	98% of Vnom., after warmup	33	35	44	A
Short Circuit					
Short Circuit Current	Hiccup technique, autorecovery within $\pm 1\%$ of Vout		5	10	A
Short Circuit Duration (remove short for recovery)	Output shorted to ground, no damage		Continuous		
Short circuit protection method	Hiccup current limiting				
Regulation					
Line Regulation	Vin=min. to max., Vout=nom., nom load		± 0.2		% of Vout
Load Regulation	Iout=min. to max		± 0.2		% of Vout
Ripple and Noise ②	5 Hz- 20 MHz BW		90	125	mV pk-pk
Temperature Coefficient	At all outputs		0.02		% of Vout./°C
Maximum Capacitive Loading	Low ESR	0	4700	10,000	μ F
MECHANICAL (THROUGH HOLE MODELS)					
Outline Dimensions					
(Please refer to outline drawing)	LxWxH		2.3x.9x.39		Inches
			58.42x22.86x9.91		mm
Weight (without baseplate)					
			0.7		Ounces
			20		Grams
Weight (with baseplate)					
			1.29		Ounces
			36.5		Grams
Through Hole Pin Diameter					
	Diameter of pins standard		0.062 & 0.04		Inches
			1.575 & 1.016		mm
Through Hole Pin Material					
			Copper alloy		
TH Pin Plating Metal and Thickness					
	Nickel subplate		50		μ -inches
	Gold overplate		5		μ -inches
Baseplate Material					
			Aluminum		
ENVIRONMENTAL					
Operating Ambient Temperature Range	See derating	-40		85	°C
Storage Temperature	Vin = Zero (no power)	-55		125	°C
Operating Base Plate Temp	No derating required	-40		100	
Thermal Protection/Shutdown	Measured at hotspot	135	140	150	°C
Electromagnetic Interference					
	External filter is required				
Conducted, EN55022/CISPR22					
			B		Class
Radiated, EN55022/CISPR22					
			B		Class
RoHS rating					
			RoHS-6		

Notes

- Unless otherwise noted, all specifications are at nominal input voltage, nominal output voltage and full load.
General conditions are +25° Celsius ambient temperature, near sea level altitude, airflow of 300lfm for extended operation time.
All models are tested and specified with external parallel 1 μ F and 10 μ F output capacitors.
A 33 μ F external input capacitor with appropriate voltage and current rating is used. All capacitors are low-ESR types wired close to the converter. The values and number of capacitors may be modified depending on the application.
- Input (back) ripple current is tested and specified over 5 Hz to 20 MHz bandwidth. Input filtering is Cbus=220 μ F, Cin=33 μ F and Lbus=12 μ H.
- All models are stable and regulate to specification under no load.
- The Remote On/Off Control is referred to -Vin. For external transistor control, use open collector logic or equivalent.
- NOTICE**—Please use only this customer data sheet as product documentation when laying out your printed circuit boards and applying this product into your application. Do NOT use other materials as official documentation such as advertisements, product announcements, or website graphics. We strive to have all technical data in this customer data sheet highly accurate and complete. This customer data sheet is revision-controlled and dated. The latest customer data sheet revision is normally on our website (www.murata-ps.com) for products which are fully released to Manufacturing. Please be especially careful using any data sheets labeled "Preliminary" since data may change without notice. Please be aware of small details that may affect your application and PC board layouts. Study the Mechanical Outline drawings, Input/Output Connection table and all footnotes very carefully. Please contact Murata Power Solutions if you have any questions.
- If reverse polarity is accidentally applied to the input, to ensure reverse input protection, always connect an external input fuse in series with the +Vin input. Use approximately twice the full input current rating with nominal input voltage.

PERFORMANCE DATA, UWE-3.3/30-Q48

Efficiency vs. Line Voltage and Load Current @ 25°C

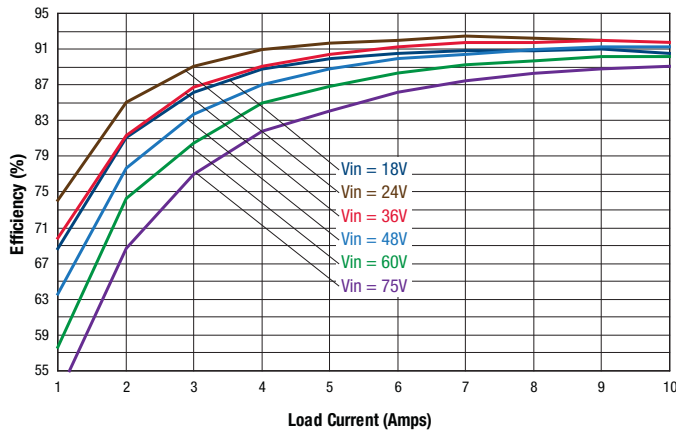

Power Dissipation vs. Line and Load

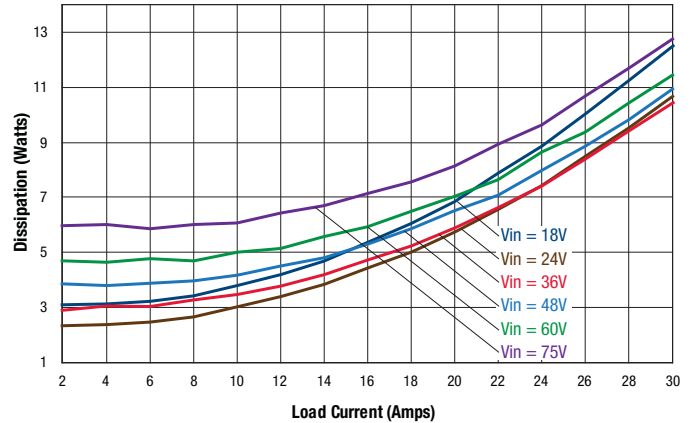

**Maximum Current Temperature Derating @ sea level
(VIN = 24V, air flow from Pin 3 to Pin 1, no baseplate)**

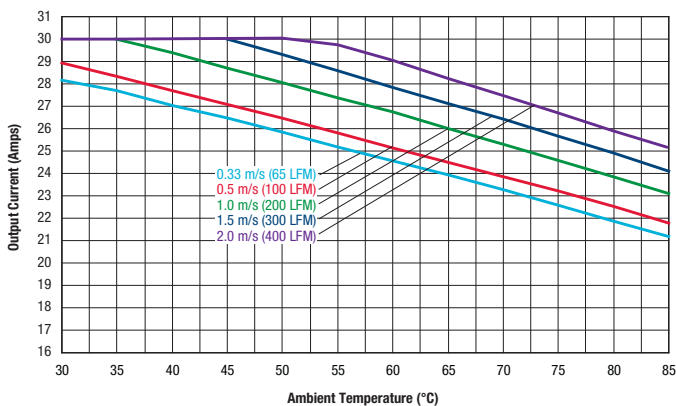

**Maximum Current Temperature Derating @sea level
(VIN = 24V, air flow from Pin 3 to Pin 1, with baseplate)**

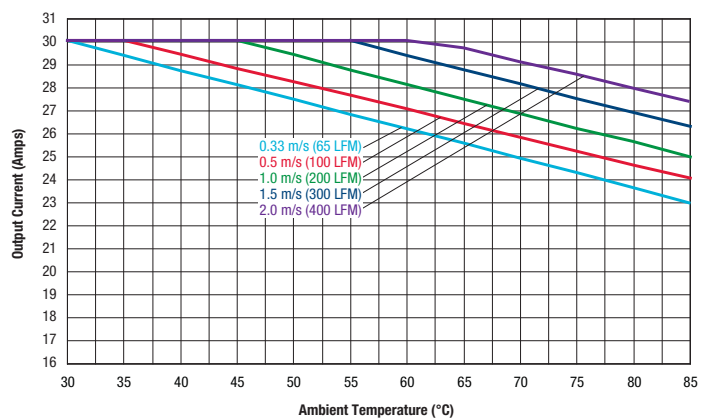

**Maximum Current Temperature Derating @sea level
(VIN = 48V, air flow from Pin 3 to Pin 1, no baseplate)**

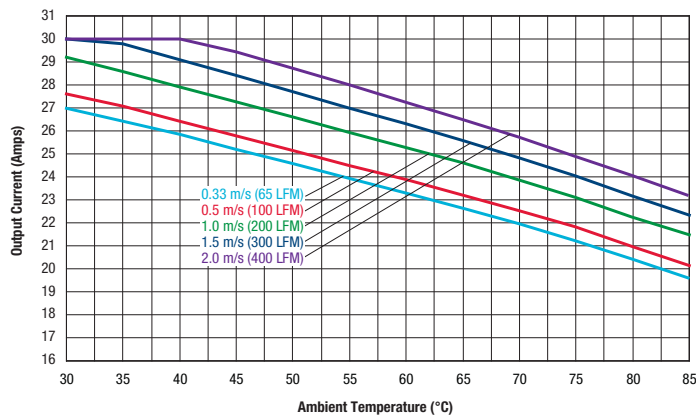

**Maximum Current Temperature Derating @sea level
(VIN = 48V, air flow from Pin 3 to Pin 1, with baseplate)**

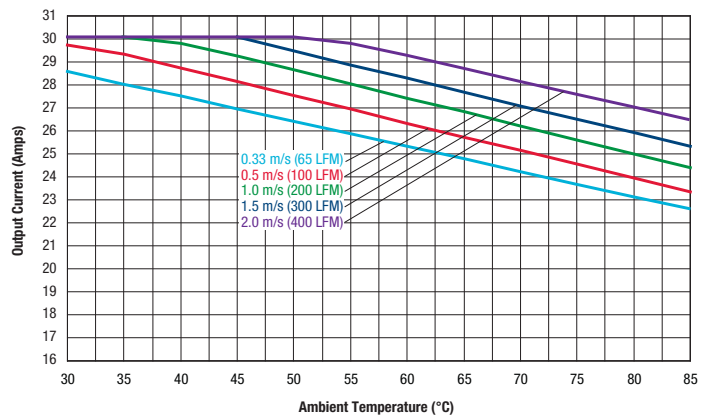

PERFORMANCE DATA, UWE-3.3/30-Q48

Startup Delay (Vin=48V, Iout=0A, Cout=0, Ta=+25°C) Trace1=Vin, Trace2=Vout.

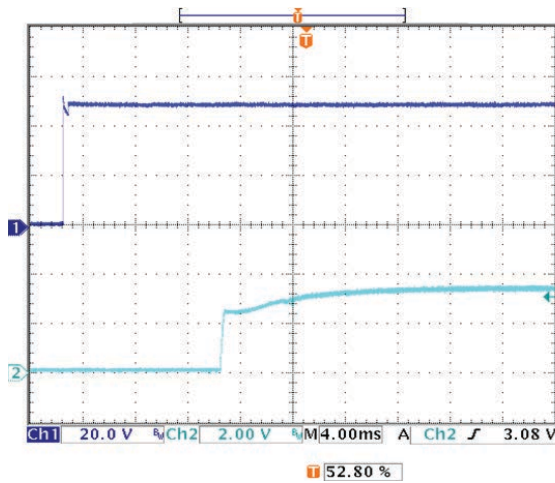

Startup Delay (Vin=48V, Iout=30A, Cout=0, Ta=+25°C) Trace1=Vin, Trace2=Vout.

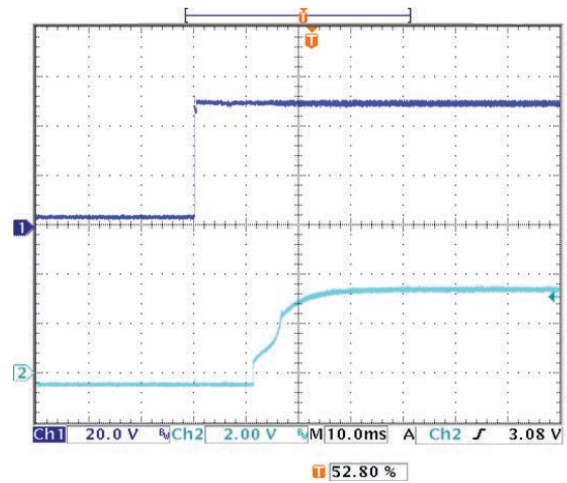

Startup Delay (Vin=48V, Iout=30A, Cout=10000µF, Ta=+25°C) Trace1=Vin, Trace2=Vout.

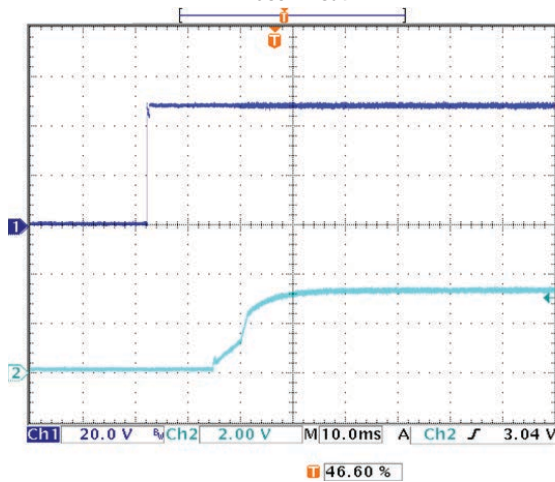

On/Off Enable Delay (Vin=48V, Iout=0A, Cout=0, Ta=+25°C) Trace1=Enable, Trace2=Vout.

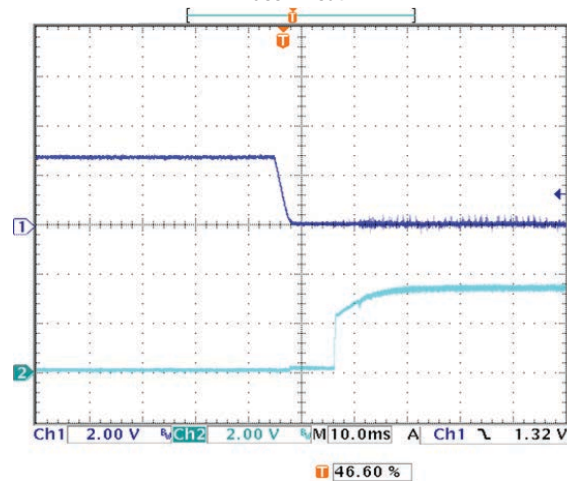

On/Off Enable Delay (Vin=48V, Iout=30A, Cout=0, Ta=+25°C) Trace1=Enable, Trace2=Vout.

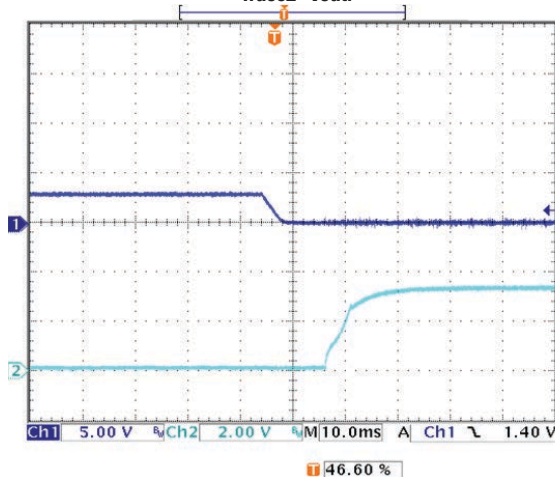

On/Off Enable Delay (Vin=48V, Iout=30A, Cout=10000µF, Ta=+25°C)

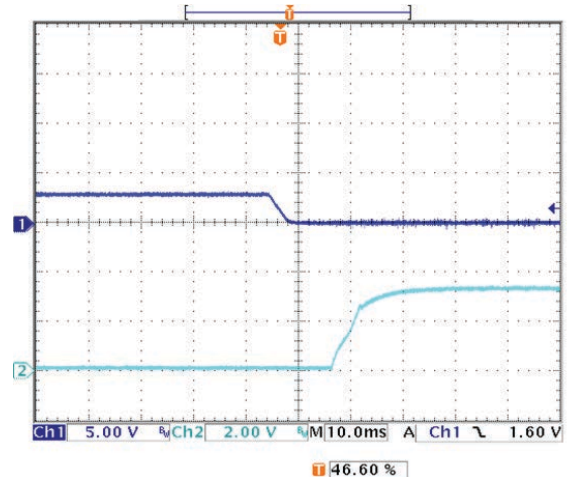

PERFORMANCE DATA, UWE-3.3/30-Q48

Stepload Transient Response ($V_{in}=48V$, $I_{out}=50-75-50\%$ of I_{out} ,
 $C_{load}=1\mu F \parallel 10\mu F$, Slew rate: $10A/\mu s$ at $T_a=+25^\circ C$)

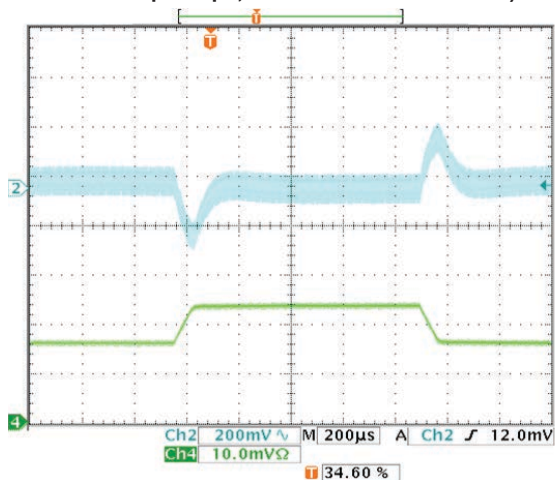

Stepload Transient Response ($V_{in}=48V$, $I_{out}=50-75-50\%$ of I_{out} ,
 $C_{load}=1\mu F \parallel 10\mu F \parallel 10000\mu F$, Slew rate: $10A/\mu s$ at $T_a=+25^\circ C$)

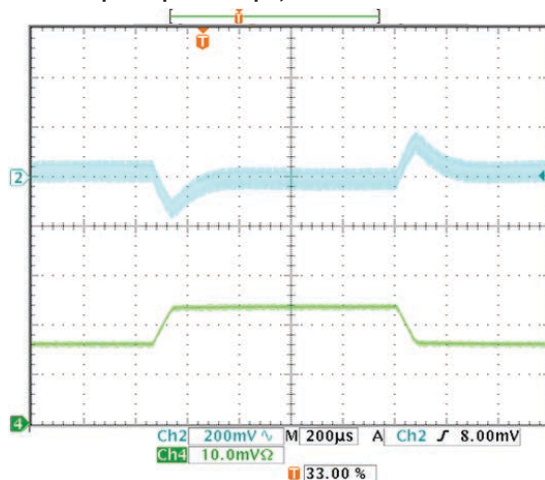

Output Ripple and Noise ($V_{in}=48V$, $V_{out}=nom$, $I_{out}=0A$, $C_{out}=1F \parallel 10\mu F$,
 $T_a=+25^\circ C$, ScopeBW=20Mhz)

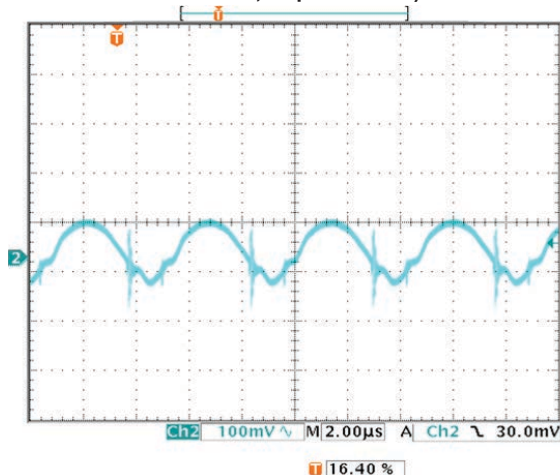

Output Ripple and Noise ($V_{in}=48V$, $V_{out}=nom$, $I_{out}=30A$, $C_{out}=1F \parallel 10\mu F$,
 $T_a=+25^\circ C$, ScopeBW=20Mhz)

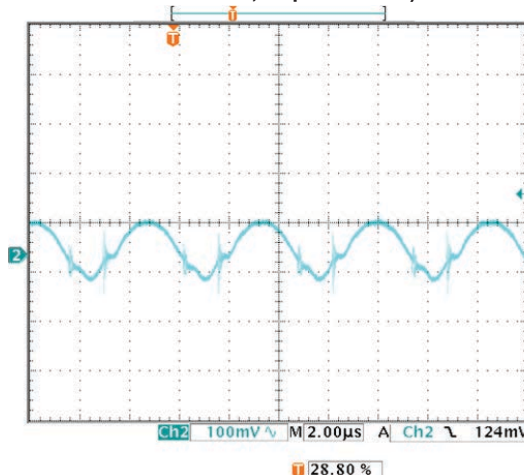

Thermal image with hot spot at 23.5A current with $25^\circ C$ ambient temperature. Natural convection is used with no forced airflow. Identifiable and recommended maximum value to be verified in application. $V_{in}=48V$, Q14 and Copper are the hot spots.

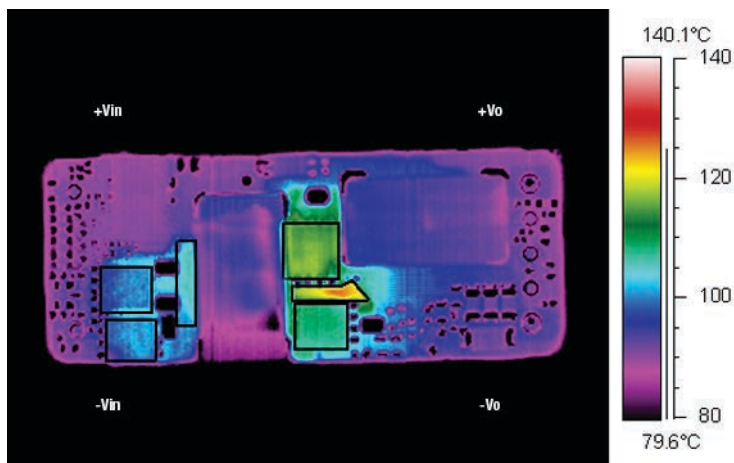

FUNCTIONAL SPECIFICATIONS, UWE-5/20-Q48-C

ABSOLUTE MAXIMUM RATINGS	CONDITIONS AND COMMENTS ①	MINIMUM	TYPICAL/NOMINAL	MAXIMUM	UNITS
Input Voltage, Continuous	Full power operation			80	Vdc
Input Voltage, Transient	Operating or non-operating, 100 mS max. duration			100	Vdc
Isolation Voltage	Input to output			2250	Vdc
Input Reverse Polarity	None, install external fuse		None		Vdc
On/Off Remote Control	Power on or off, referred to -Vin	0		15	Vdc
Output Power		0		101	W
Output Current	Current-limited, no damage, short-circuit protected	0		20	A
Storage Temperature Range	Vin = Zero (no power)	-55		125	°C
Absolute maximums are stress ratings. Exposure of devices to greater than any of these conditions may adversely affect long-term reliability. Proper operation under conditions other than those listed in the Performance/Functional Specifications Table is not implied or recommended.					
INPUT	CONDITIONS AND COMMENTS ① ③				
Operating voltage range		18	48	75	Vdc
Recommended External Fuse	Fast blow			10	A
Start-up threshold, Turn On	Rising input voltage	17	17.5	17	Vdc
Undervoltage shutdown, Turn Off : @10A load	Falling input voltage	15.5	16	17.5	Vdc
Turn-On/Turn-Off Hysteresis		1	1.5		Vdc
Overvoltage shutdown			NA		Vdc
Reverse Polarity Protection	None, install external fuse		None		Vdc
Internal Filter Type			L-C-type		
Input current					
Full Load Conditions	Vin = nominal		2.30	2.36	A
Low Line	Vin = minimum		6.11	6.27	A
Inrush Transient			0.1		A ² -Sec.
Short Circuit Input Current			250	350	mA
No Load Input Current	Iout = minimum, unit=ON		100	135	mA
Standby Mode Input Current (Off, UV, OT)			5	10	mA
Reflected (back) ripple current ②	no filtering		500	600	mA, P-P
Reflected (back) ripple current ②	Measured at input with specified filter		30	40	mA, P-P
Pre-biased startup	Monotonic				
GENERAL AND SAFETY					
Efficiency	Vin=24V, full load	90.5	92		%
	Vin=min. to max.	89.5	91		%
	Vin=48V, full load	89	90.5		%
Isolation					
Isolation Voltage, input to output	No baseplate	2250			Vdc
Isolation Voltage, input to output	With baseplate	2250			Vdc
Isolation Voltage, input to baseplate	With baseplate	1500			Vdc
Isolation Voltage, output to baseplate	With baseplate	750			Vdc
Insulation Safety Rating			basic		
Isolation Resistance			100		MΩ
Isolation Capacitance			1000		pF
Safety	Certified to UL-60950-1, CSA-C22.2 No.60950-1, IEC60950-1, 2nd edition and IEC62368		Yes		
Calculated MTBF	Per Telcordia SR332, issue 1, class 3, ground fixed, Tambient=-+40C		TBD		Hours x 10 ³
DYNAMIC CHARACTERISTICS					
Fixed Switching Frequency		200	225	250	KHz
Startup Time	Power on, Vout regulated		20	30	mS
Startup Time	Remote ON to Vout regulated		20	30	mS
Dynamic Load Response	50-75-50% load step, settling time to within 2% of Vout.		100	200	μSec
Dynamic Load Peak Deviation	same as above		±450		mV
FEATURES AND OPTIONS					
Remote On/Off Control ④					
"N" suffix:					
Negative Logic, ON state	ON = Pin grounded or external voltage	0		0.8	V
Negative Logic, OFF state	OFF = Pin open or external voltage	3.5		15	V
Control Current	open collector/drain		1	2	mA
"P" suffix:					
Positive Logic, ON state	ON = Pin open or external voltage	5		15	V
Positive Logic, OFF state	OFF = Ground pin or external voltage	0		0.8	V
Control Current	open collector/drain		1	2	mA
Base Plate	"B" suffix				

FUNCTIONAL SPECIFICATIONS, UWE-5/20-Q48-C (CONT.)

OUTPUT					
Total Output Power		0	100	101	W
Voltage					
Nominal Output Voltage	No trim	4.95	5	5.05	Vdc
Settling Accuracy	At 50% load	-1		1	% of Vset.
Output Voltage Range	User-adjustable (see trim formulas)	-10		10	% of Vnom.
Overvoltage Protection	Via magnetic feedback		6.5	7	Vdc
Current					
Output Current Range		0	20	20	A
Minimum Load	No minimum load				
Current Limit Inception	98% of Vnom., after warmup	23	27	32	A
Short Circuit					
Short Circuit Current	Hiccup technique, autorecovery within $\pm 1\%$ of Vout		1.5	2.5	A
Short Circuit Duration (remove short for recovery)	Output shorted to ground, no damage		Continuous		
Short circuit protection method	Hiccup current limiting				
Regulation					
Line Regulation	Vin=min. to max., Vout=nom., nom load		± 0.1		% of Vout
Load Regulation	Iout=min. to max		± 0.2		% of Vout
Ripple and Noise ②	5 Hz- 20 MHz BW		75	110	mV pk-pk
Temperature Coefficient	At all outputs		0.02		% of Vout./°C
Maximum Capacitive Loading	Low ESR	0		10,000	μF
MECHANICAL (THROUGH HOLE MODELS)					
Outline Dimensions			2.3x.9x.39		Inches
(Please refer to outline drawing)	LxWxH		58.42x22.86x9.91		mm
Weight (without baseplate)			0.7		Ounces
			20		Grams
Weight (with baseplate)			1.29		Ounces
			36.5		Grams
Through Hole Pin Diameter	Diameter of pins standard		0.062 & 0.04		Inches
			1.575 & 1.016		mm
Through Hole Pin Material			Copper alloy		
TH Pin Plating Metal and Thickness	Nickel subplate		50		μ -inches
	Gold overplate		5		μ -inches
Baseplate Material			Aluminum		
ENVIRONMENTAL					
Operating Ambient Temperature Range	See derating	-40		85	°C
Storage Temperature	Vin = Zero (no power)	-55		125	°C
Operating Base Plate Temp	No derating required	-40		105	
Thermal Protection/Shutdown	Measured at hotspot	135	140	150	°C
Electromagnetic Interference	External filter is required				
Conducted, EN55022/CISPR22			B		Class
Radiated, EN55022/CISPR22			B		Class
RoHS rating			RoHS-6		

Notes

- ① Unless otherwise noted, all specifications are at nominal input voltage, nominal output voltage and full load.
General conditions are +25° Celsius ambient temperature, near sea level altitude, airflow of 300lfm for extended operation time.
All models are tested and specified with external parallel 1 μF and 10 μF output capacitors.
A 33 μF external input capacitor is used. All capacitors are low-ESR types wired close to the converter. These capacitors are necessary for our test equipment and may not be needed in the user's application.
- ② Input (back) ripple current is tested and specified over 5 Hz to 20 MHz bandwidth. Input filtering is Cbus=220 μF , Cin=33 μF and Lbus=12 μH .
- ③ All models are stable and regulate to specification under no load.
- ④ The Remote On/Off Control is referred to -Vin. For external transistor control, use open collector logic or equivalent.
- ⑤ NOTICE—Please use only this customer data sheet as product documentation when laying out your printed circuit boards and applying this product into your application. Do NOT use other materials as official documentation such as advertisements, product announcements, or website graphics. We strive to have all technical data in this customer data sheet highly accurate and complete. This customer data sheet is revision-controlled and dated. The latest customer data sheet revision is normally on our website (www.murata-ps.com) for products which are fully released to Manufacturing. Please be especially careful using any data sheets labeled "Preliminary" since data may change without notice. Please be aware of small details that may affect your application and PC board layouts. Study the Mechanical Outline drawings, Input/Output Connection table and all footnotes very carefully. Please contact Murata Power Solutions if you have any questions.
- ⑥ If reverse polarity is accidentally applied to the input, to ensure reverse input protection, always connect an external input fuse in series with the +Vin input. Use approximately twice the full input current rating with nominal input voltage.

PERFORMANCE DATA, UWE-5/20-Q48-C

Efficiency vs. Line Voltage and Load Current @ 25°C

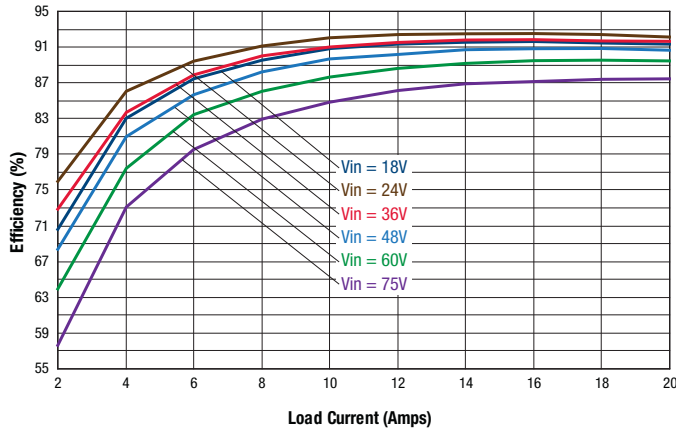

Power Dissipation vs. Line and Load

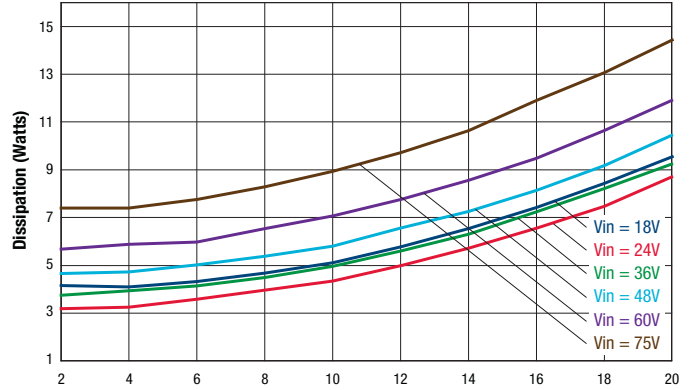

**Maximum Current Temperature Derating @sea level
(VIN = 48V, air flow from Pin 1 to Pin 3, no baseplate)**

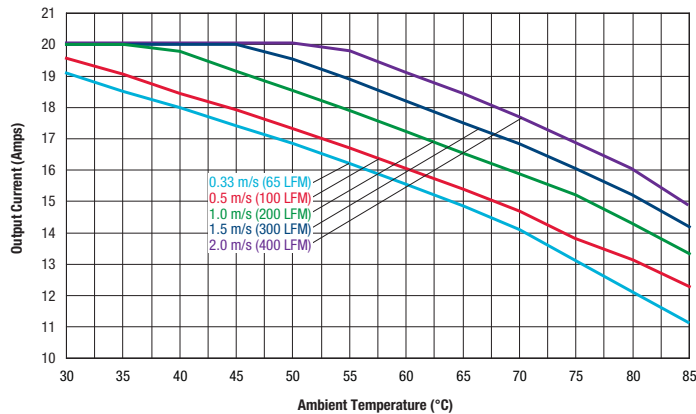

**Maximum Current Temperature Derating @sea level
(VIN = 48V, air flow from Pin 1 to Pin 3, with baseplate)**

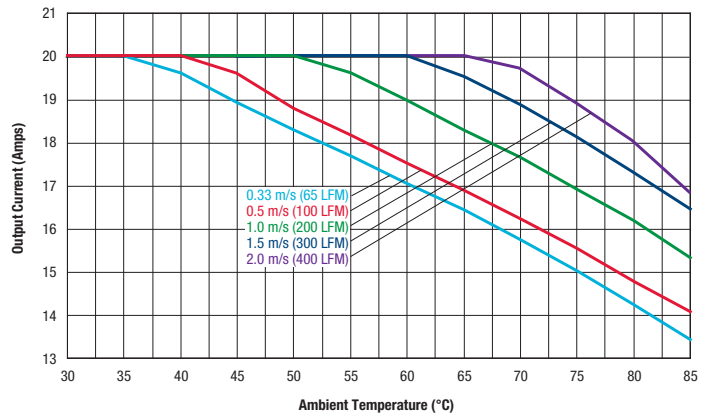

PERFORMANCE DATA, UWE-5/20-Q48-C

Startup Delay (Vin=48V, Iout=0A, Cout=0, Ta=+25°C) Trace1=Vin, Trace2=Vout.

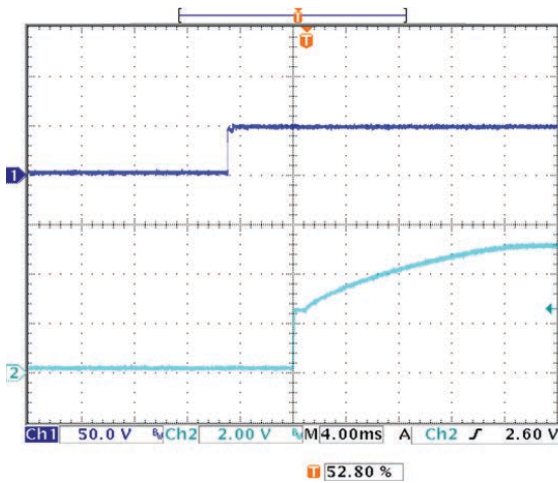

Startup Delay (Vin=48V, Iout=20A, Cout=0, Ta=+25°C) Trace1=Vin, Trace2=Vout.

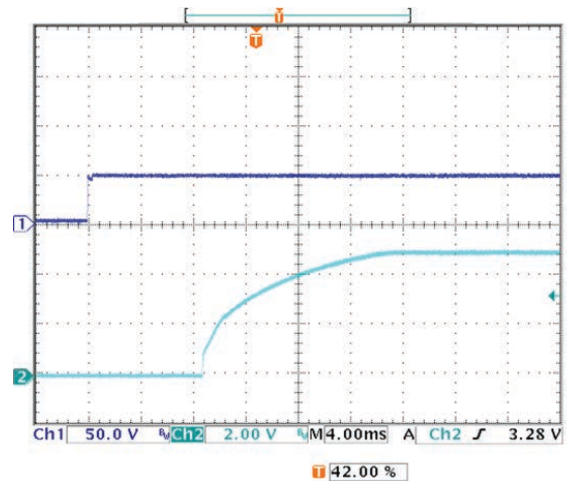

Startup Delay (Vin=48V, Iout=20A, Cout=10000µF, Ta=+25°C) Trace1=Vin, Trace2=Vout.

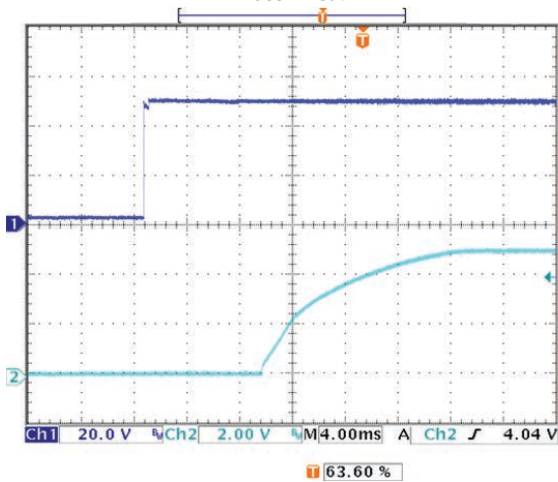

On/Off Enable Delay (Vin=48V, Iout=0A, Cout=0, Ta=+25°C) Trace1=Enable, Trace2=Vout.

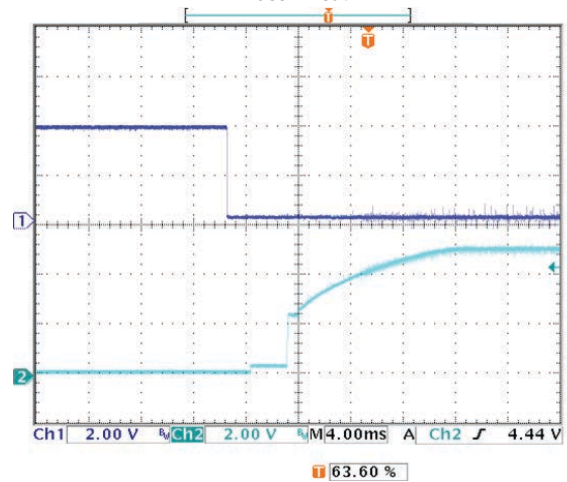

On/Off Enable Delay (Vin=48V, Iout=20A, Cout=0, Ta=+25°C) Trace1=Enable, Trace2=Vout.

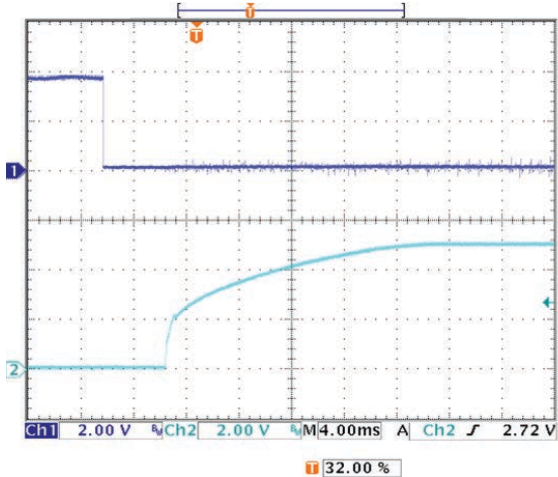

On/Off Enable Delay (Vin=48V, Iout=20A, Cout=10000µF, Ta=+25°C) Trace1=Enable, Trace2=Vout.

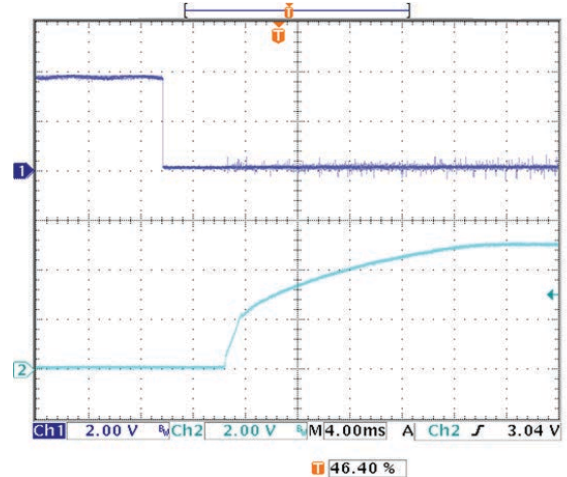

PERFORMANCE DATA, UWE-5/20-Q48-C

Stepload Transient Response ($V_{in}=48V$, $I_{out}=50-75-50\%$ of I_{out} , $C_{load}=1\mu F \parallel 10\mu F$, Slew rate: $10A/\mu s$ at $T_a=+25^\circ C$)

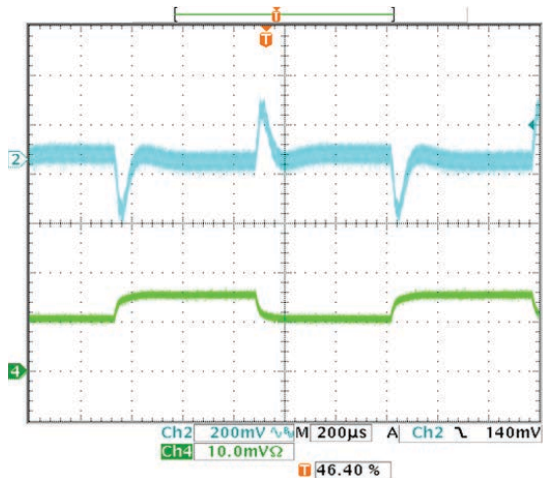

Stepload Transient Response ($V_{in}=48V$, $I_{out}=50-75-50\%$ of I_{out} , $C_{load}=1\mu F \parallel 10\mu F \parallel 10000\mu F$, Slew rate: $10A/\mu s$ at $T_a=+25^\circ C$)

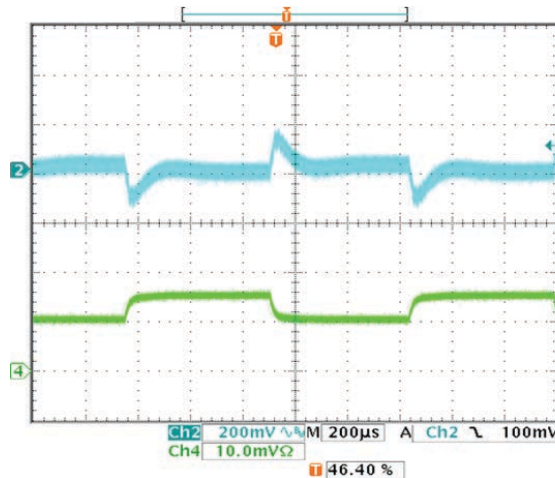

Output Ripple and Noise ($V_{in}=48V$, $V_{out}=nom$, $I_{out}=0A$, $C_{out}=1F \parallel 10\mu F$, $T_a=+25^\circ C$, ScopeBW=20Mhz)

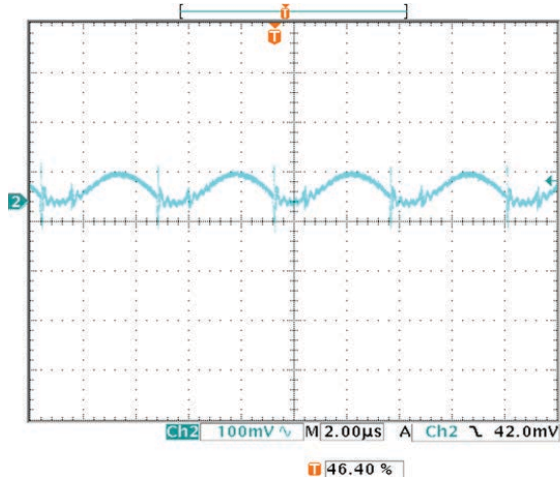

Output Ripple and Noise ($V_{in}=48V$, $V_{out}=nom$, $I_{out}=20A$, $C_{out}=1F \parallel 10\mu F$, $T_a=+25^\circ C$, ScopeBW=20Mhz)

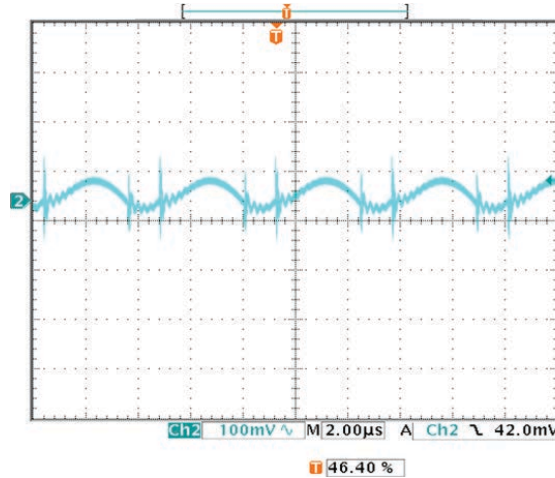

Thermal image with hot spot at 17A current with $25^\circ C$ ambient temperature. Natural convection is used with no forced airflow. Identifiable and recommended maximum value to be verified in application. $V_{in}=48V$, Q14 is the hot spot.

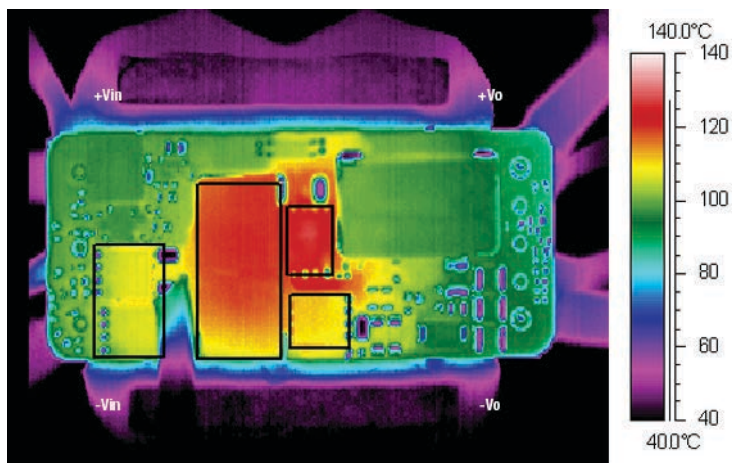

FUNCTIONAL SPECIFICATIONS, UWE-12/10-Q48

ABSOLUTE MAXIMUM RATINGS	CONDITIONS AND COMMENTS ①	MINIMUM	TYPICAL/NOMINAL	MAXIMUM	UNITS
Input Voltage, Continuous	Full power operation			80	Vdc
Input Voltage, Transient	Operating or non-operating, 100 mS max. duration			100	Vdc
Isolation Voltage	Input to output			2250	Vdc
Input Reverse Polarity	None, install external fuse		None		Vdc
On/Off Remote Control	Power on or off, referred to -Vin	0		15	Vdc
Output Power		0		121.2	W
Output Current	Current-limited, no damage, short-circuit protected	0		10	A
Storage Temperature Range	Vin = Zero (no power)	-55		125	°C
Absolute maximums are stress ratings. Exposure of devices to greater than any of these conditions may adversely affect long-term reliability. Proper operation under conditions other than those listed in the Performance/Functional Specifications Table is not implied or recommended.					
INPUT	CONDITIONS AND COMMENTS ① ③				
Operating voltage range		18	48	75	Vdc
Recommended External Fuse	Fast blow			15 ⑥	A
Start-up threshold, Turn On	Rising input voltage	17	17.5	17.9	Vdc
Undervoltage shutdown, Turn Off	Falling input voltage	16	16.45	17.5	Vdc
Turn-On/Turn-Off Hysteresis		0.81	0.86		Vdc
Overvoltage shutdown			NA		Vdc
Reverse Polarity Protection	None, install external fuse		None		Vdc
Internal Filter Type			Pi-type		
Input current					
Full Load Conditions	Vin = nominal		2.732	2.806	A
Low Line	Vin = minimum		7.286	7.481	A
Inrush Transient			0.1		A ² -Sec.
Output in Short Circuit			100	150	mA
No Load Input Current (Iout @ min)	Iout = minimum, unit=ON		110	150	mA
Shut-Down Mode Input Current			4	8	mA
Reflected (back) ripple current ②	no filtering		400	500	mA, P-P
Reflected (back) ripple current ②	Measured at input with specified filter		40	50	mA, P-P
Pre-biased startup	Monotonic				
GENERAL AND SAFETY					
Efficiency	Vin=24V, full load	90.5	92.5		%
	Vin=min.	90	91.5		%
	Vin=48V, full load	90	91.5		%
Isolation					
Isolation Voltage, input to output	No baseplate	2250			Vdc
Isolation Voltage, input to output	With baseplate	2250			Vdc
Isolation Voltage, input to baseplate	With baseplate	1500			Vdc
Isolation Voltage, output to baseplate	With baseplate	500			Vdc
Insulation Safety Rating			basic		
Isolation Resistance			100		MΩ
Isolation Capacitance			1000		pF
Safety	Certified to UL-60950-1, CSA-C22.2 No.60950-1, IEC60950-1, 2nd edition; IEC62368		Yes		
Calculated MTBF	Per Telcordia SR332, issue 1, class 3, ground fixed, Tambient=+25°C		3.1		Hours x 10 ⁶
DYNAMIC CHARACTERISTICS					
Fixed Switching Frequency		200	220	240	KHz
Startup Time	Power on to Vout regulated		30	40	mS
Startup Time	Remote ON to Vout regulated		20	30	mS
Dynamic Load Response	50-75-50% load step, settling time to within ±2% of Vout		100	200	µSec
Dynamic Load Peak Deviation	same as above		±650		mV
FEATURES AND OPTIONS					
Remote On/Off Control ④					
"N" suffix:					
Negative Logic, ON state	ON = Pin grounded or external voltage	1		1	V
Negative Logic, OFF state	OFF = Pin open or external voltage	3.5		15	V
Control Current	open collector/drain		1	2	mA
"P" suffix:					
Positive Logic, ON state	ON = Pin open or external voltage	3.5		15	V
Positive Logic, OFF state	OFF = Ground pin or external voltage	0		0.8	V
Control Current	open collector/drain		1	2	mA
Base Plate	"B" suffix				

FUNCTIONAL SPECIFICATIONS, UWE-12/10-Q48 (CONT.)

OUTPUT					
Total Output Power		0	120	121.2	W
Voltage					
Nominal Output Voltage	No trim	11.88	12	12.12	Vdc
Setting Accuracy	At 50% load	-1		1	% of Vset.
Output Voltage Range	User-adjustable	-10		10	% of Vnom.
Overvoltage Protection	Via magnetic feedback		15	16	Vdc
Current					
Output Current Range		0	10	10	A
Minimum Load	No minimum load				
Current Limit Inception	98% of Vnom., after warmup	11.5	12.5	14	A
Short Circuit					
Short Circuit Current	Hiccup technique, autorecovery within $\pm 1\%$ of Vout		1	2	A
Short Circuit Duration (remove short for recovery)	Output shorted to ground, no damage		Continuous		
Short circuit protection method	Hiccup current limiting				
Regulation					
Line Regulation	Vin=min. to max., Vout=nom., nom load		± 0.15		% of Vout
Load Regulation	Iout=min. to max		± 0.075		% of Vout
Ripple and Noise ②	5 Hz- 20 MHz BW		115	200	mV pk-pk
Temperature Coefficient	At all outputs		0.02		% of Vout./°C
Maximum Capacitive Loading	Low ESR	0	4700		μ F
MECHANICAL (THROUGH HOLE MODELS)					
Outline Dimensions			2.3x.9x.39		Inches
(Please refer to outline drawing)	LxWxH		58.42x22.86x9.91		mm
Weight (without baseplate)			0.7		Ounces
			20		Grams
Weight (with baseplate)			1.29		Ounces
			36.5		Grams
Through Hole Pin Diameter	Diameter of pins standard		0.062 & 0.04		Inches
			1.575 & 1.016		mm
Through Hole Pin Material			Copper alloy		
TH Pin Plating Metal and Thickness	Nickel subplate		50		μ -inches
	Gold overplate		5		μ -inches
Baseplate Material			Aluminum		
ENVIRONMENTAL					
Operating Ambient Temperature Range	See derating curves	-40		85	°C
Storage Temperature	Vin = Zero (no power)	-55		125	°C
Operating Base Plate Temp	No derating required	-40		100	
Thermal Protection/Shutdown	Measured at hotspot	135	140	150	°C
Electromagnetic Interference	External filter is required				
Conducted, EN55022/CISPR22			B		Class
Radiated, EN55022/CISPR22			B		Class
RoHS rating			RoHS-6		

Notes

- ① Unless otherwise noted, all specifications are at nominal input voltage, nominal output voltage and full load.
General conditions are +25° Celsius ambient temperature, near sea level altitude, airflow rate of 300lfm for extended operation time.
All models are tested and specified with external parallel 1 μ F and 10 μ F output capacitors.
A 33 μ F external input capacitor is used. All capacitors are low-ESR types wired close to the converter. These capacitors are necessary for our test equipment and may not be needed in the user's application.
- ② Input (back) ripple current is tested and specified over 5 Hz to 20 MHz bandwidth. Input filtering is Cbus=220 μ F, Cin=33 μ F and Lbus=12 μ H.
- ③ All models are stable and regulate to specification under no load.
- ④ The Remote On/Off Control is referred to -Vin. For external transistor control, use open collector logic or equivalent.
- ⑤ NOTICE—Please use only this customer data sheet as product documentation when laying out your printed circuit boards and applying this product into your application. Do NOT use other materials as official documentation such as advertisements, product announcements, or website graphics. We strive to have all technical data in this customer data sheet highly accurate and complete. This customer data sheet is revision-controlled and dated. The latest customer data sheet revision is normally on our website (www.murata-ps.com) for products which are fully released to Manufacturing. Please be especially careful using any data sheets labeled "Preliminary" since data may change without notice. Please be aware of small details that may affect your application and PC board layouts. Study the Mechanical Outline drawings, Input/Output Connection table and all footnotes very carefully. Please contact Murata Power Solutions if you have any questions.
- ⑥ If reverse polarity is accidentally applied to the input, to ensure reverse input protection, always connect an external input fuse in series with the +Vin input. Use approximately twice the full input current rating with nominal input voltage.

PERFORMANCE DATA, UWE-12/10-Q48

Efficiency vs. Line Voltage and Load Current @ 25°C

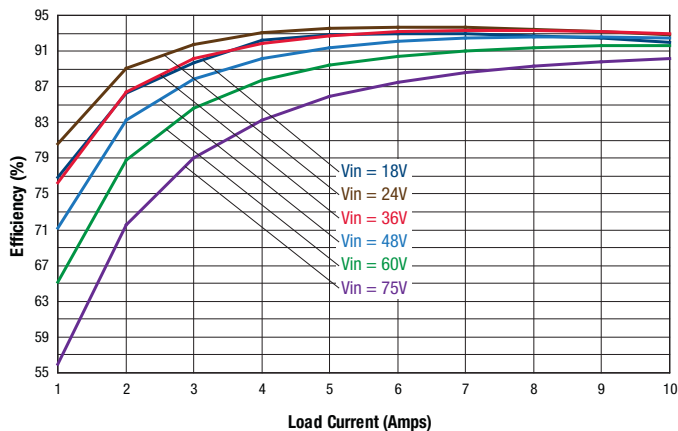

Power Dissipation vs. Line and Load

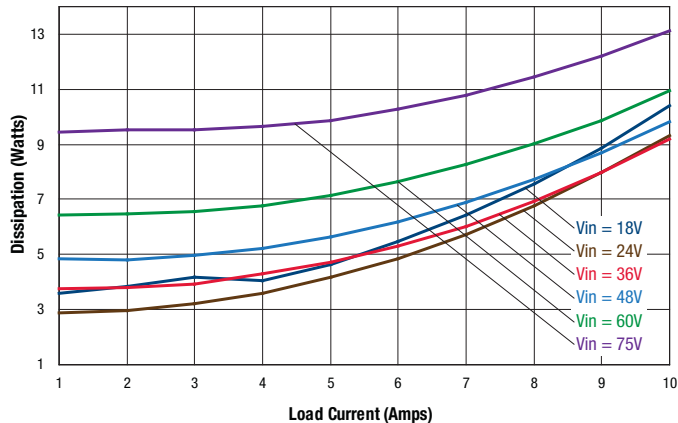

**Maximum Current Temperature Derating @ sea level
(VIN = 24V, air flow from Pin 1 to Pin 3, no baseplate)**

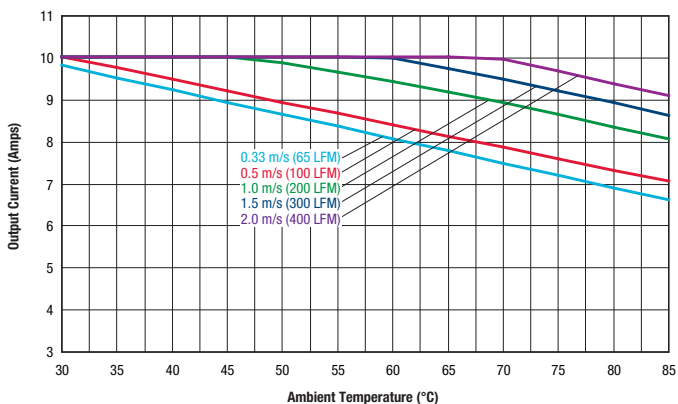

**Maximum Current Temperature Derating @sea level
(VIN = 24V, air flow from Pin 1 to Pin 3, with baseplate)**

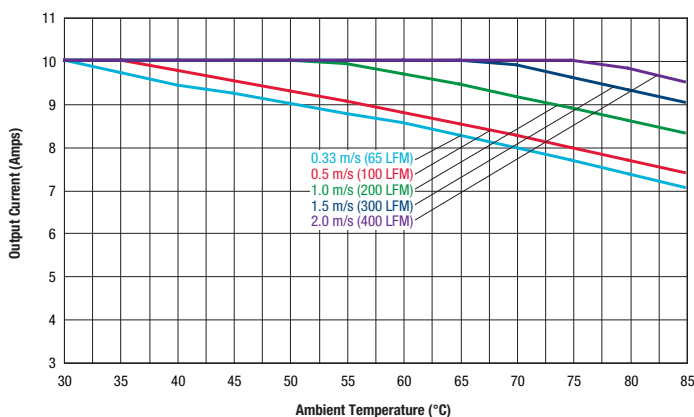

**Maximum Current Temperature Derating @sea level
(VIN = 48V, air flow from Pin 1 to Pin 3, no baseplate)**

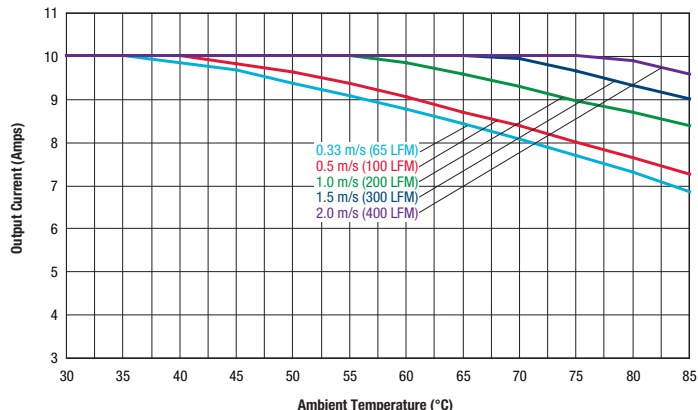

**Maximum Current Temperature Derating @sea level
(VIN = 48V, air flow from Pin 1 to Pin 3, with baseplate)**

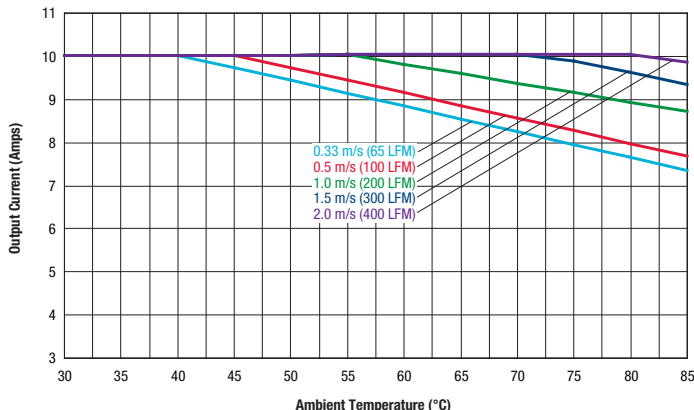

PERFORMANCE DATA, UWE-12/10-Q48

Startup Delay (Vin=48V, Iout=0A, Cout=0, Ta=+25°C) Trace1=Vin, Trace2=Vout.

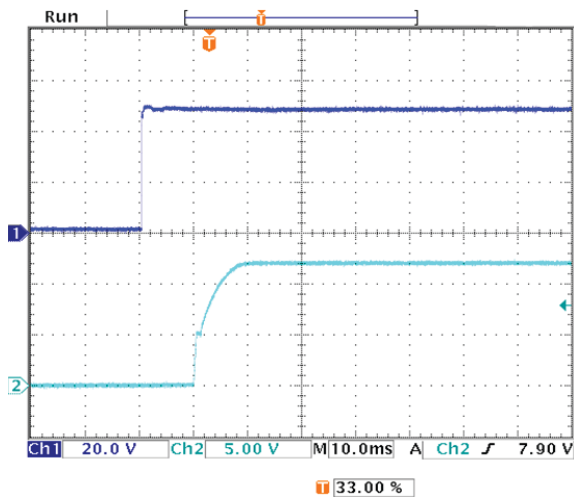

Startup Delay (Vin=48V, Iout=10A, Cout=0, Ta=+25°C) Trace1=Vin, Trace2=Vout.

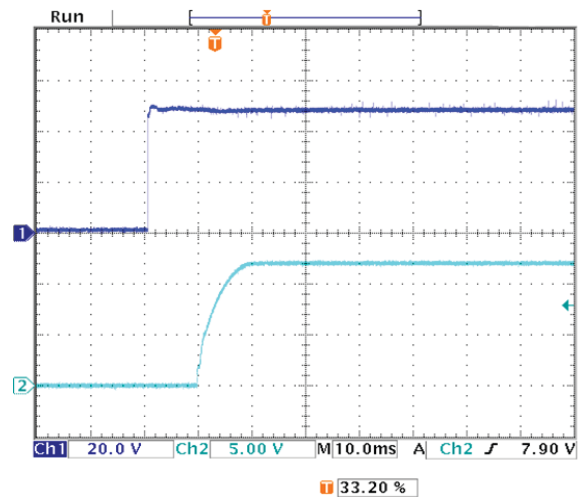

Startup Delay (Vin=48V, Iout=10A, Cout=4700µF, Ta=+25°C) Trace1=Vin, Trace2=Vout.

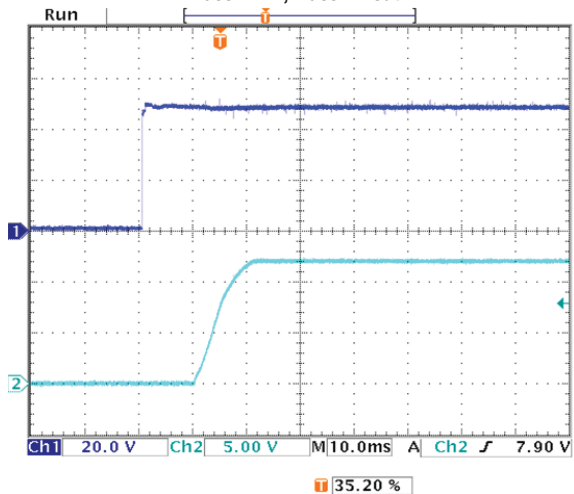

On/Off Enable Delay (Vin=48V, Iout=0A, Cout=0, Ta=+25°C) Trace1=Enable, Trace2=Vout.

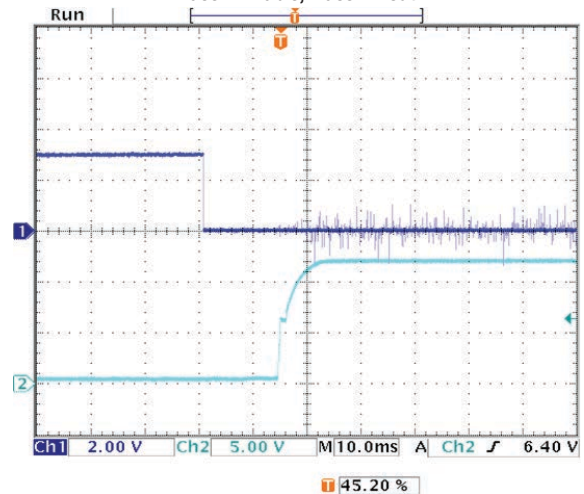

On/Off Enable Delay (Vin=48V, Iout=10A, Cout=0, Ta=+25°C) Trace1=Enable, Trace2=Vout.

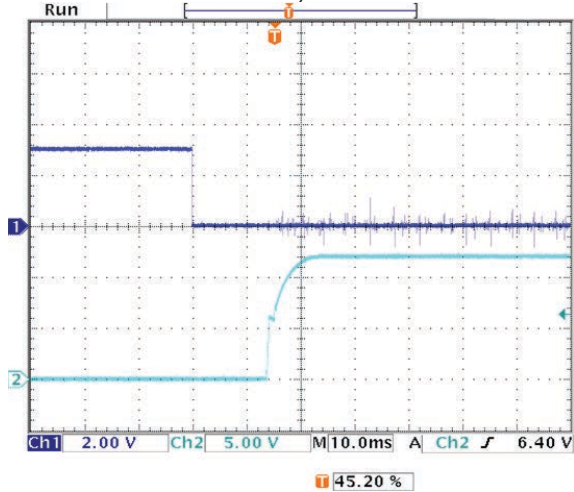

On/Off Enable Delay (Vin=48V, Iout=10A, Cout=4700µF, Ta=+25°C) Trace1=Enable, Trace2=Vout.

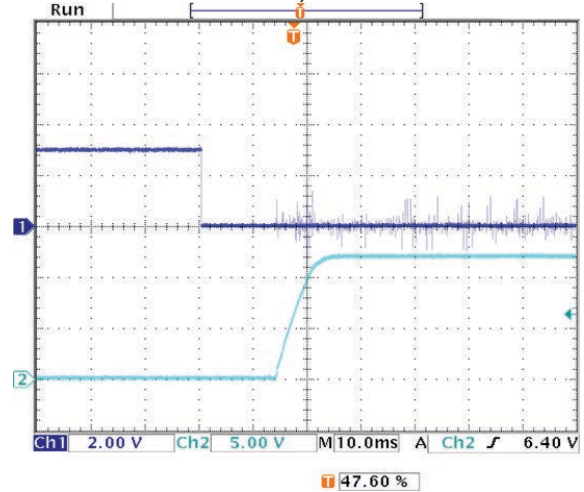

PERFORMANCE DATA, UWE-12/10-Q48

Stepload Transient Response (Vin=48V, Iout=50-100-50% of Iout, Cload= 1μF || 10μF, Slew rate: 5A/uS at Ta=+25°C)

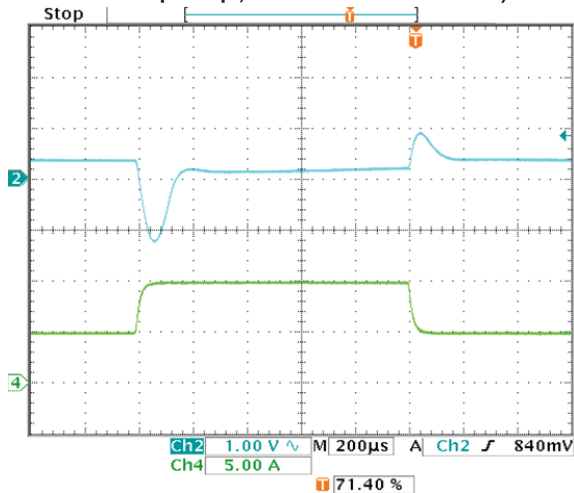

Stepload Transient Response (Vin=48V, Iout=50-100-50% of Iout, Cload= 1μF || 10μF || 4700μF, Slew rate: 5A/uS at Ta=+25°C)

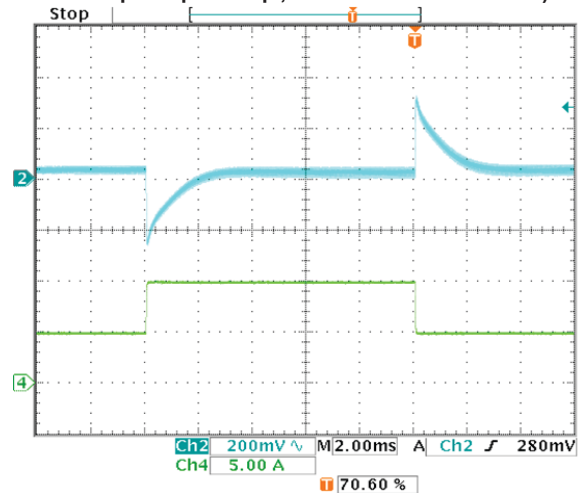

Stepload Transient Response (Vin=48V, Iout=50-75-50% of Iout, Cload= 1μF || 10μF || 4700μF, Slew rate: 5A/uS at Ta=+25°C)

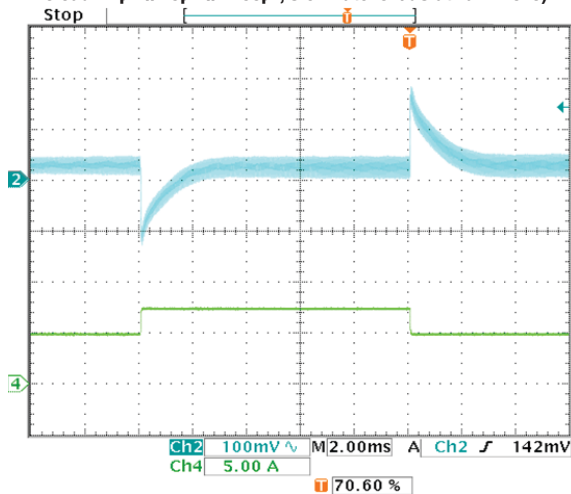

Output Ripple and Noise (Vin=48V, Vout=nom, Iout=0A, Cout=1F || 10μF, Ta=+25°C, ScopeBW=20Mhz)

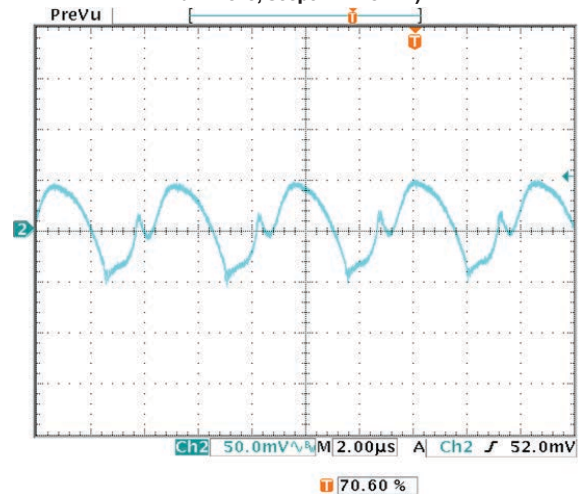

Output Ripple and Noise (Vin=48V, Vout=nom, Iout=10A, Cout=1F || 10μF, Ta=+25°C, ScopeBW=20Mhz)

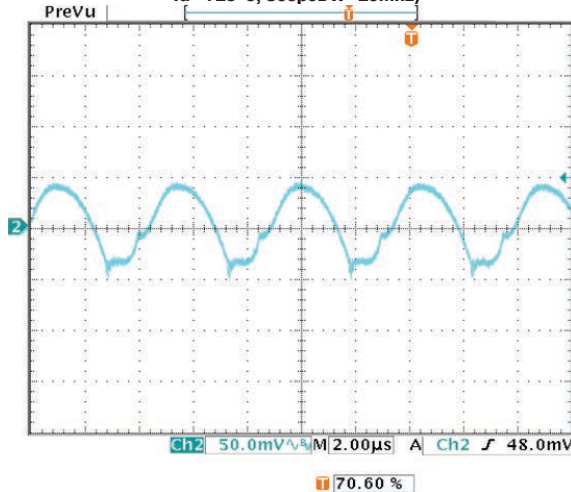

Output Ripple and Noise (Vin=48V, Vout=nom, Iout=10A, Cout=1F || 10μF || 4700μF, Ta=+25°C, ScopeBW=20Mhz)

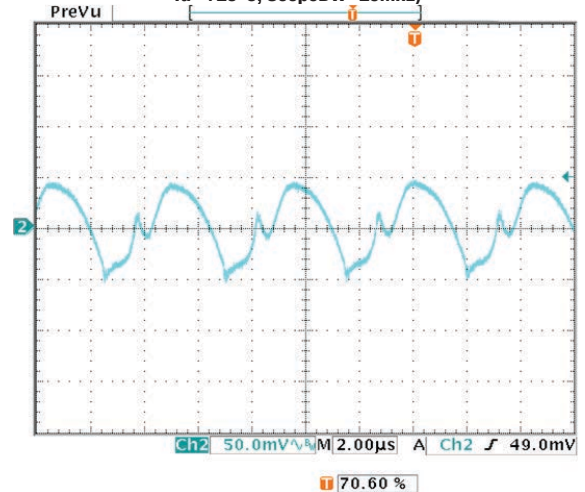

PERFORMANCE DATA, UWE-12/10-Q48

Thermal image with hot spot at 8.24A current with 25°C ambient temperature. Natural convection is used with no forced airflow. Identifiable and recommended maximum value to be verified in application. Vin=48V, Q14 is the hot spot.

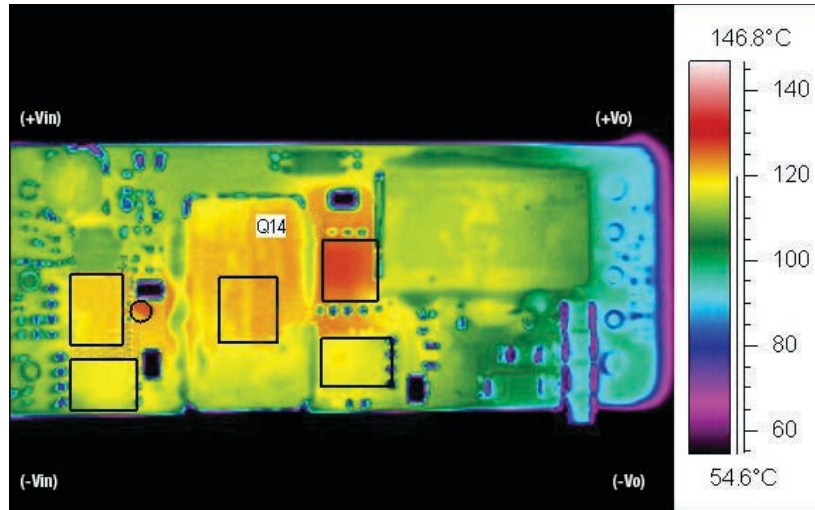

FUNCTIONAL SPECIFICATIONS, UWE-12/10-Q12

ABSOLUTE MAXIMUM RATINGS	CONDITIONS AND COMMENTS ①	MINIMUM	TYPICAL/NOMINAL	MAXIMUM	UNITS
Input Voltage, Continuous	Full power operation			36	Vdc
Input Voltage, Transient	Operating or non-operating, 100 mS max. duration			50	Vdc
Isolation Voltage	Input to output				Vdc
Input Reverse Polarity	None, install external fuse		None		Vdc
On/Off Remote Control	Power on or off, referred to -Vin	0		15	Vdc
Output Power		0		121.2	W
Output Current	Current-limited, no damage, short-circuit protected	0		10	A
Storage Temperature Range	Vin = Zero (no power)	-55		125	°C
Absolute maximums are stress ratings. Exposure of devices to greater than any of these conditions may adversely affect long-term reliability. Proper operation under conditions other than those listed in the Performance/Functional Specifications Table is not implied or recommended.					
INPUT	CONDITIONS AND COMMENTS ① ③				
Operating voltage range ⑦		9	12	36	Vdc
Recommended External Fuse	Fast blow			20	A
Start-up threshold, Turn On	Rising input voltage	9.5	10	10.5	Vdc
Undervoltage shutdown, Turn Off	Falling input voltage	7.5	8	8.9	Vdc
Turn-On/Turn-Off Hysteresis		1	2		Vdc
Overshoot shutdown			NA		Vdc
Reverse Polarity Protection	None, install external fuse		None		Vdc
Internal Filter Type			Pi-type		
Input current					
Full Load Conditions	Vin = nominal		10.95	11.29	A
Low Line	Vin = minimum		14.73	15.13	A
Inrush Transient			0.1		A ² -Sec.
Output in Short Circuit			100	150	mA
No Load Input Current (Iout @ min)	Iout = minimum, unit=ON		260	340	mA
Shut-Down Mode Input Current			5	8	mA
Reflected (back) ripple current ②	no filtering		200	250	mA, P-P
Reflected (back) ripple current ②	Measured at input with specified filter		20	30	mA, P-P
Pre-biased startup	Monotonic				
GENERAL AND SAFETY					
Efficiency	Vin=12V, full load	89.5	91.3		%
	Vin=min.	89	90.5		%
	Vin=24V, full load	89.5	91.4		%
Isolation					
Isolation Voltage, input to output	No baseplate			2250	Vdc
Isolation Voltage, input to output	With baseplate			2250	Vdc
Isolation Voltage, input to baseplate	With baseplate			1500	Vdc
Isolation Voltage, output to baseplate	With baseplate			750	Vdc
Insulation Safety Rating			basic		
Isolation Resistance			100		MΩ
Isolation Capacitance			1000		pF
Safety	Certified to UL-60950-1, CSA-C22.2 No.60950-1, IEC60950-1, 2nd edition; IEC62368		Yes		
Calculated MTBF	Per Telcordia SR332, issue 1, class 3, ground fixed, Tambient=+25°C		TBC		Hours x 10 ⁶
DYNAMIC CHARACTERISTICS					
Fixed Switching Frequency		200	220	240	KHz
Startup Time	Power on to Vout regulated		25	40	mS
Startup Time	Remote ON to Vout regulated		25	40	mS
Dynamic Load Response	50-75-50% load step, settling time to within ±2% of Vout		50	100	µSec
Dynamic Load Peak Deviation	same as above		±110	±200	mV
FEATURES AND OPTIONS					
Remote On/Off Control ④					
"N" suffix:					
Negative Logic, ON state	ON = Pin grounded or external voltage	0		1	V
Negative Logic, OFF state	OFF = Pin open or external voltage	3.5		15	V
Control Current	open collector/drain		1	2	mA
"P" suffix:					
Positive Logic, ON state	ON = Pin open or external voltage	3.5		15	V
Positive Logic, OFF state	OFF = Ground pin or external voltage	0		0.8	V
Control Current	open collector/drain		1	2	mA
Base Plate	"B" suffix				

FUNCTIONAL SPECIFICATIONS, UWE-12/10-Q12 (CONT.)

OUTPUT	CONDITIONS AND COMMENTS ①	MINIMUM	TYPICAL/NOMINAL	MAXIMUM	UNITS
Total Output Power		0	120	121.2	W
Voltage					
Nominal Output Voltage	No trim	11.88	12	12.12	Vdc
Setting Accuracy	At 50% load	-1		1	% of Vset.
Output Voltage Range	User-adjustable	-10		10	% of Vnom.
Overvoltage Protection	Via magnetic feedback		15	16	Vdc
Current					
Output Current Range		0		10	A
Minimum Load	No minimum load				
Current Limit Inception	98% of Vnom., after warmup	11.5	13.5	15.5	A
Short Circuit					
Short Circuit Current	Hiccup technique, autorecovery within $\pm 1\%$ of Vout		1	2	A
Short Circuit Duration (remove short for recovery)	Output shorted to ground, no damage		Continuous		
Short circuit protection method	Hiccup current limiting				
Regulation					
Line Regulation	Vin=min. to max., Vout=nom., nom load		± 0.15		% of Vout
Load Regulation	Iout=min. to max		± 0.075	± 0.15	% of Vout
Ripple and Noise ②	5 Hz- 20 MHz BW		115	200	mV pk-pk
Temperature Coefficient	At all outputs		0.02		% of Vout./°C
Maximum Capacitive Loading	Low ESR	0	4700		μ F
MECHANICAL (THROUGH HOLE MODELS)					
Outline Dimensions			2.3x.9x0.34		Inches
(Please refer to outline drawing)	LxWxH		58.42x22.86x8.64		mm
Weight (without baseplate)			0.7		Ounces
			20		Grams
Weight (with baseplate)			1.29		Ounces
			36.5		Grams
Through Hole Pin Diameter	Diameter of pins standard		0.062 & 0.04		Inches
			1.575 & 1.016		mm
Through Hole Pin Material			Copper alloy		
TH Pin Plating Metal and Thickness	Nickel subplate		50		μ -inches
	Gold overplate		5		μ -inches
Baseplate Material			Aluminum		
ENVIRONMENTAL					
Operating Ambient Temperature Range	See derating curves	-40		85	°C
Storage Temperature	Vin = Zero (no power)	-55		125	°C
Operating Base Plate Temp	No derating required	-40		100	
Thermal Protection/Shutdown	Measured at hotspot	135	140	150	°C
Electromagnetic Interference	External filter is required				
Conducted, EN55022/CISPR22			B		Class
Radiated, EN55022/CISPR22			B		Class
RoHS rating			RoHS-6		

Notes

- ① Unless otherwise noted, all specifications are at nominal input voltage, nominal output voltage and full load.
General conditions are +25° Celsius ambient temperature, near sea level altitude, airflow rate of 300lfm for extended operation time.
All models are tested and specified with external parallel 1 μ F and 10 μ F output capacitors.
A 33 μ F external input capacitor is used. All capacitors are low-ESR types wired close to the converter. These capacitors are necessary for our test equipment and may not be needed in the user's application.
- ② Input (back) ripple current is tested and specified over 5 Hz to 20 MHz bandwidth. Input filtering is Cbus=220 μ F, Cin=33 μ F and Lbus=12 μ H.
- ③ All models are stable and regulate to specification under no load.
- ④ The Remote On/Off Control is referred to -Vin. For external transistor control, use open collector logic or equivalent.
- ⑤ NOTICE—Please use only this customer data sheet as product documentation when laying out your printed circuit boards and applying this product into your application. Do NOT use other materials as official documentation such as advertisements, product announcements, or website graphics.

- We strive to have all technical data in this customer data sheet highly accurate and complete. This customer data sheet is revision-controlled and dated. The latest customer data sheet revision is normally on our website (www.murata-ps.com) for products which are fully released to Manufacturing. Please be especially careful using any data sheets labeled "Preliminary" since data may change without notice. Please be aware of small details that may affect your application and PC board layouts. Study the Mechanical Outline drawings, Input/Output Connection table and all footnotes very carefully. Please contact Murata Power Solutions if you have any questions.
- ⑥ If reverse polarity is accidentally applied to the input, to ensure reverse input protection, always connect an external input fuse in series with the +Vin input. Use approximately twice the full input current rating with nominal input voltage.
 - ⑦ Operating Voltage Range is specified as the Input Voltage operating range of the converter after start-up. The Start-up Threshold, Turn On voltage is higher than the lowest Operating Voltage. The device will not begin to operate until the Start-up Threshold (Vin) voltage is applied. After Start-Up the device will operate normally over the specified Operating Voltage Range.

PERFORMANCE DATA, UWE-12/10-Q12

Efficiency vs. Line Voltage and Load Current @ 25°C

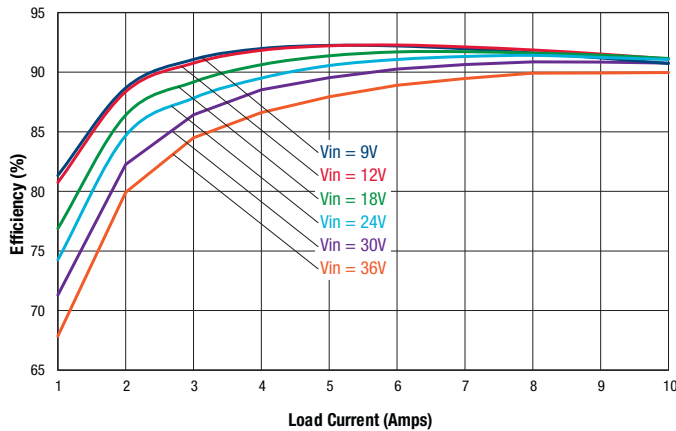

Power Dissipation vs. Line and Load

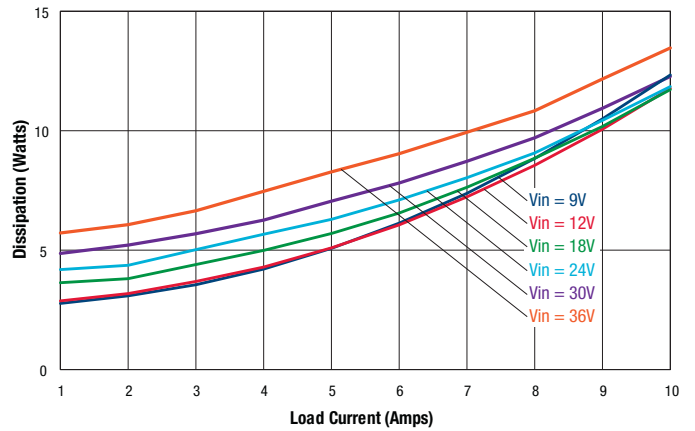

**Maximum Current Temperature Derating @ sea level
(VIN = 9V, air flow from Pin 1 to Pin 3, no baseplate)**

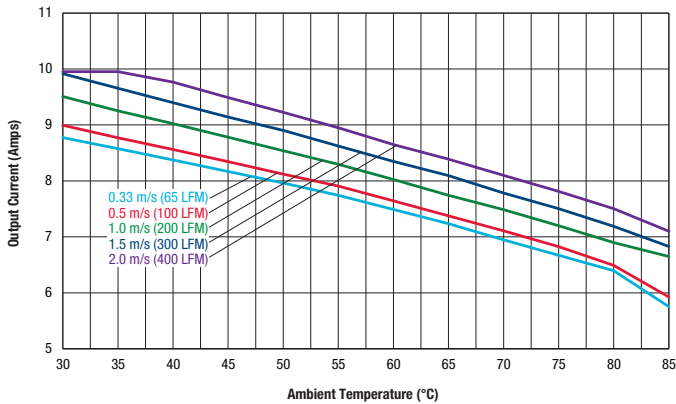

**Maximum Current Temperature Derating @sea level
(VIN = 9V, air flow from Pin 1 to Pin 3, with baseplate)**

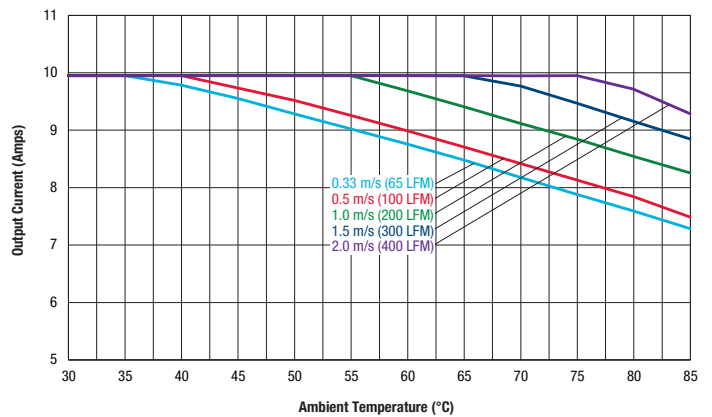

**Maximum Current Temperature Derating @ sea level
(VIN = 12V, air flow from Pin 1 to Pin 3, no baseplate)**

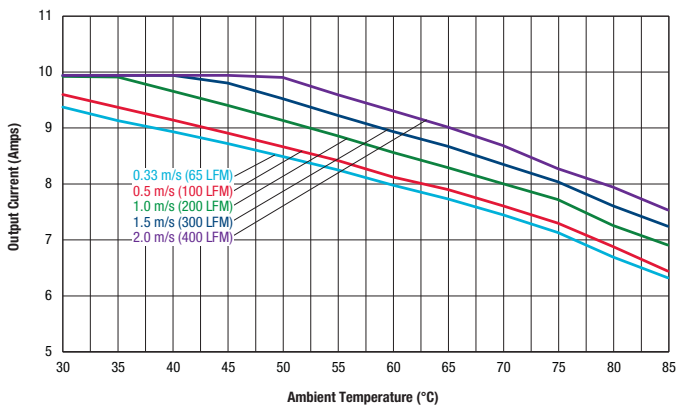

**Maximum Current Temperature Derating @sea level
(VIN = 12V, air flow from Pin 1 to Pin 3, with baseplate)**

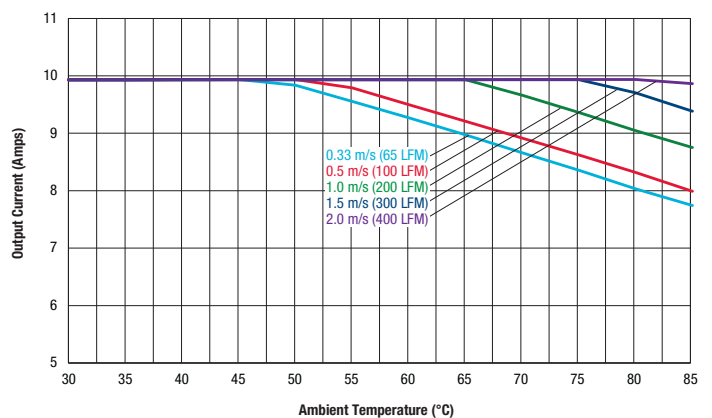

PERFORMANCE DATA, UWE-12/10-Q12

Maximum Current Temperature Derating @ sea level
($V_{IN} = 18V$, air flow from Pin 1 to Pin 3, no baseplate)

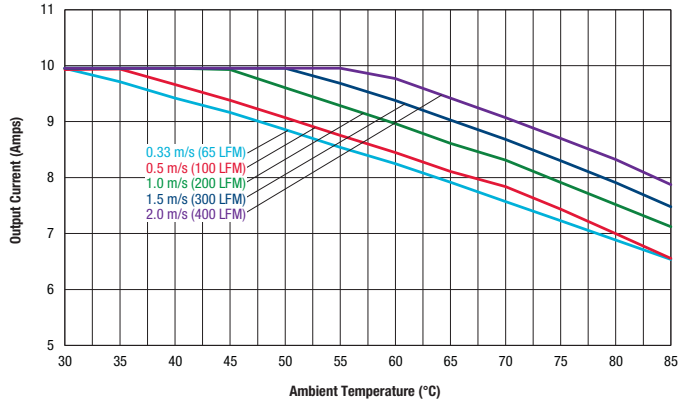

Maximum Current Temperature Derating @sea level
($V_{IN} = 18V$, air flow from Pin 1 to Pin 3, with baseplate)

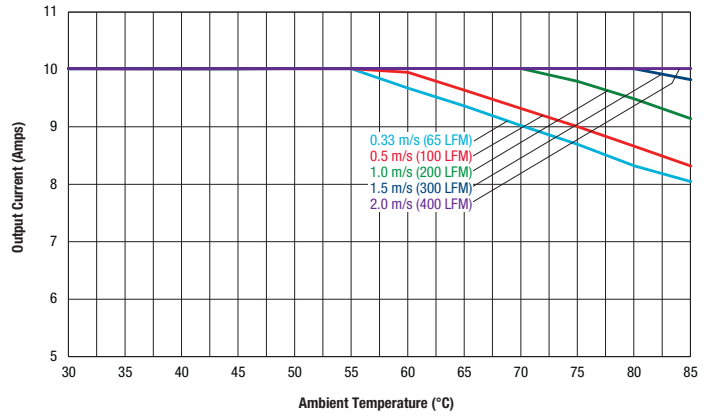

Maximum Current Temperature Derating @ sea level
($V_{IN} = 24V$, air flow from Pin 1 to Pin 3, no baseplate)

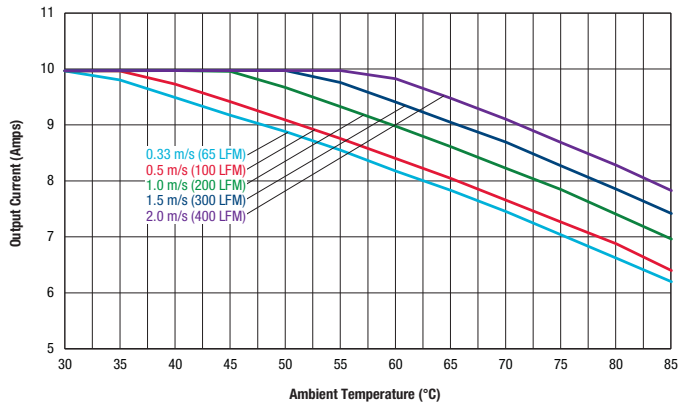

Maximum Current Temperature Derating @sea level
($V_{IN} = 24V$, air flow from Pin 1 to Pin 3, with baseplate)

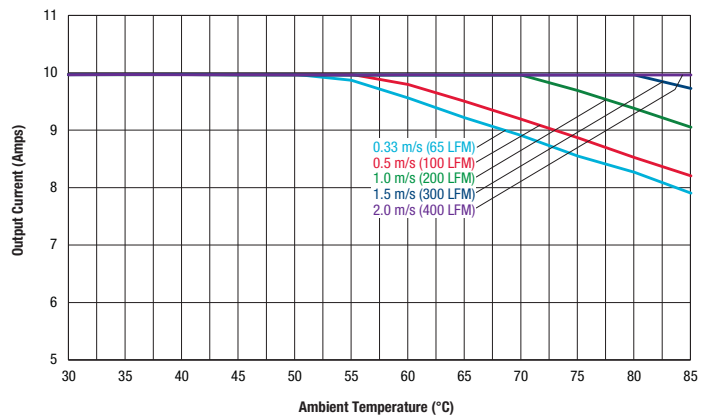

Maximum Current Temperature Derating @ sea level
($V_{IN} = 36V$, air flow from Pin 1 to Pin 3, no baseplate)

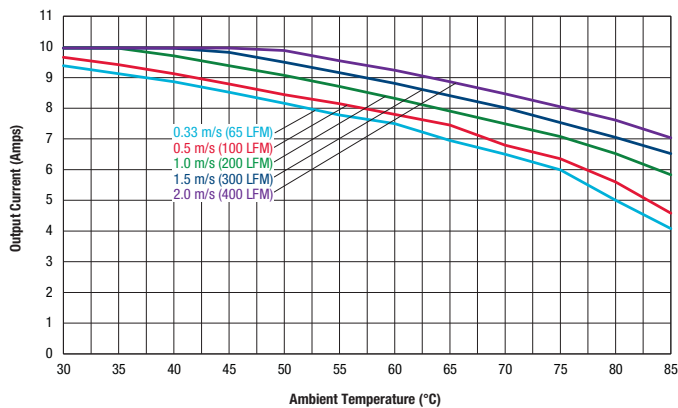

Maximum Current Temperature Derating @sea level
($V_{IN} = 36V$, air flow from Pin 1 to Pin 3, with baseplate)

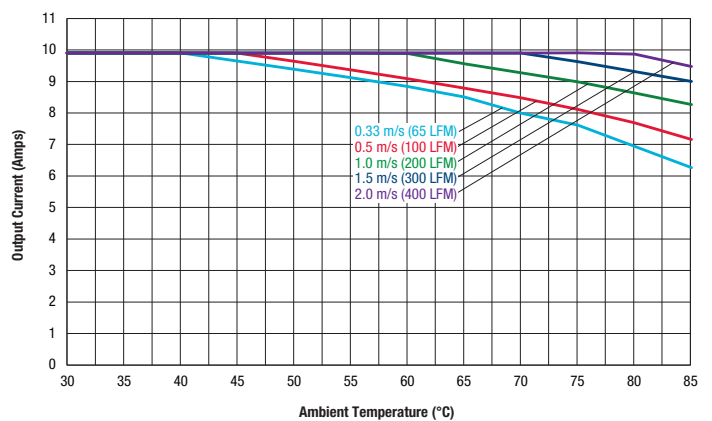

PERFORMANCE DATA, UWE-12/10-Q12

Startup Delay (Vin=12V, Iout=0A, Cout=0, Ta=+25°C) Trace1=Vin, Trace2=Vout.

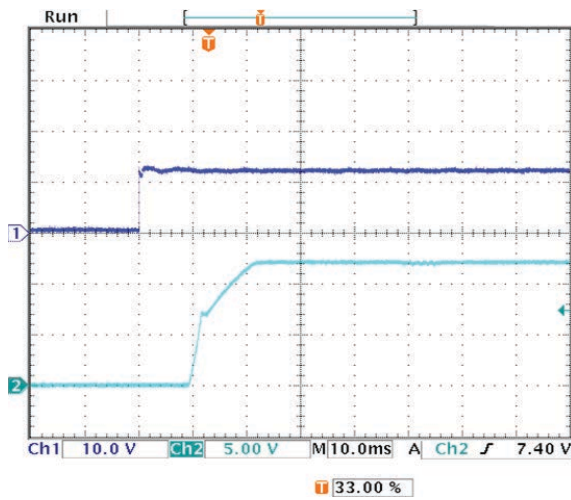

Startup Delay (Vin=12V, Iout=10A, Cout=0, Ta=+25°C) Trace1=Vin, Trace2=Vout.

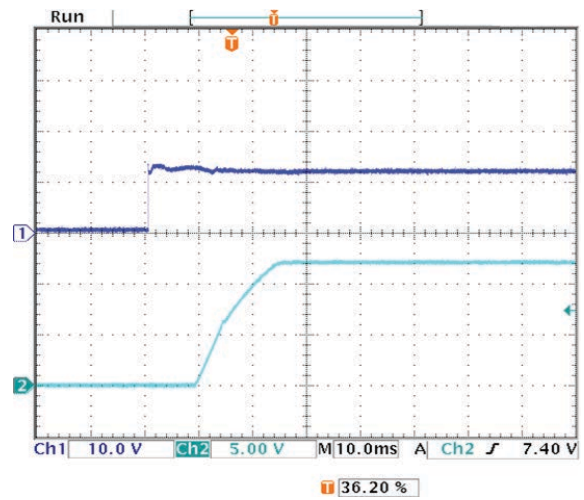

Startup Delay (Vin=12V, Iout=10A, Cout=5000µF, Ta=+25°C) Trace1=Vin, Trace2=Vout.

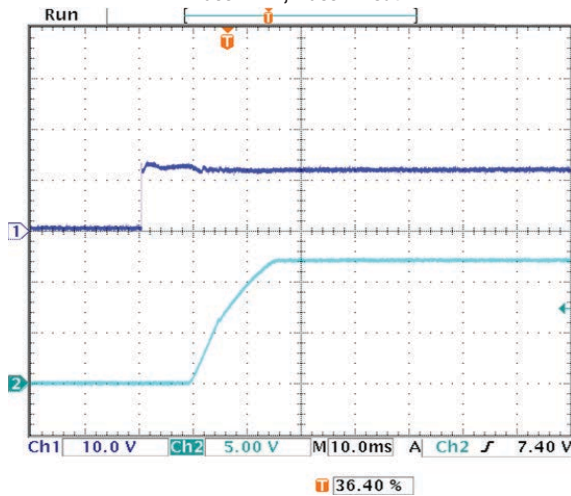

On/Off Enable Delay (Vin=12V, Iout=0A, Cout=0, Ta=+25°C) Trace1=Enable, Trace2=Vout.

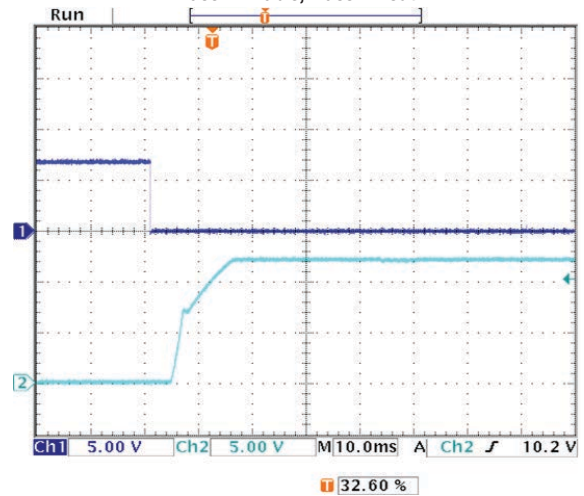

On/Off Enable Delay (Vin=12V, Iout=10A, Cout=0, Ta=+25°C) Trace1=Enable, Trace2=Vout.

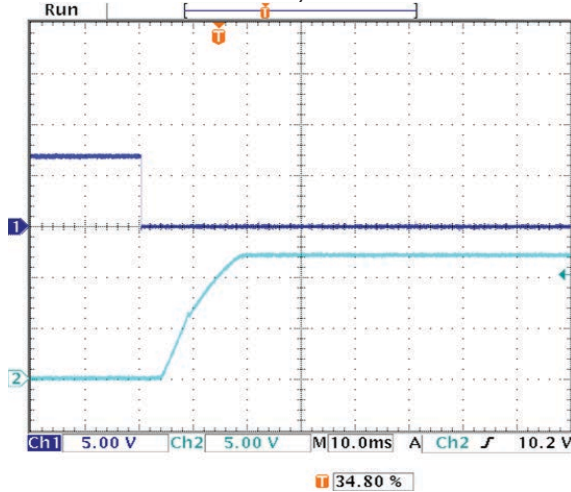

On/Off Enable Delay (Vin=12V, Iout=10A, Cout=5000µF, Ta=+25°C) Trace1=Enable, Trace2=Vout.

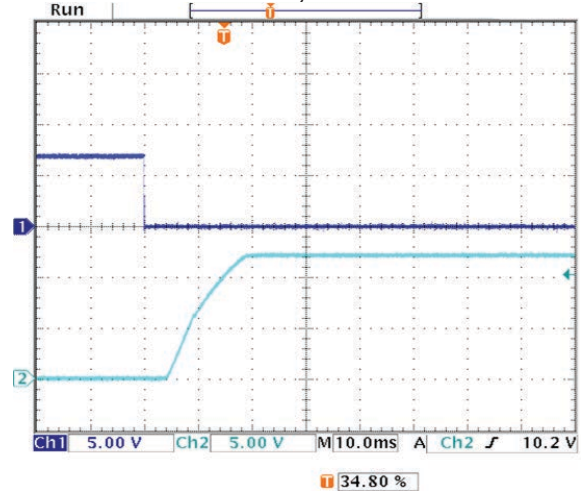

PERFORMANCE DATA, UWE-12/10-Q12

Stepload Transient Response ($V_{in}=12V$, $I_{out}=50-100-50\%$ of I_{out} , $C_{load}=1\mu F \parallel 10\mu F$, Slew rate: $5A/\mu S$ at $T_a=+25^\circ C$)

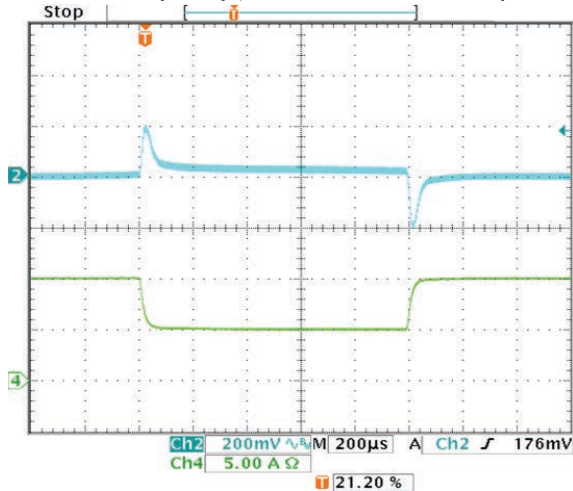

Stepload Transient Response ($V_{in}=12V$, $I_{out}=50-100-50\%$ of I_{out} , $C_{load}=1\mu F \parallel 10\mu F \parallel 5000\mu F$, Slew rate: $5A/\mu S$ at $T_a=+25^\circ C$)

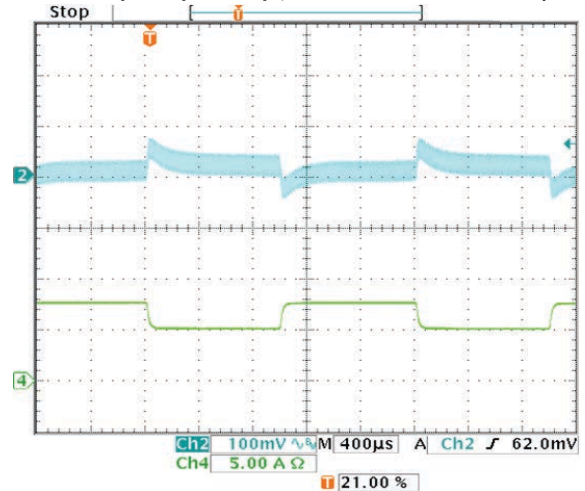

Stepload Transient Response ($V_{in}=12V$, $I_{out}=50-75-50\%$ of I_{out} , $C_{load}=1\mu F \parallel 10\mu F \parallel 5000\mu F$, Slew rate: $5A/\mu S$ at $T_a=+25^\circ C$)

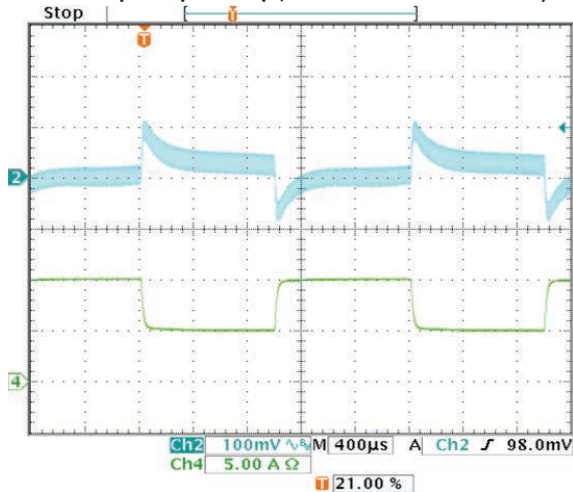

Output Ripple and Noise ($V_{in}=12V$, $V_{out}=nom$, $I_{out}=0A$, $C_{out}=1F \parallel 10\mu F$, $T_a=+25^\circ C$, ScopeBW=20Mhz)

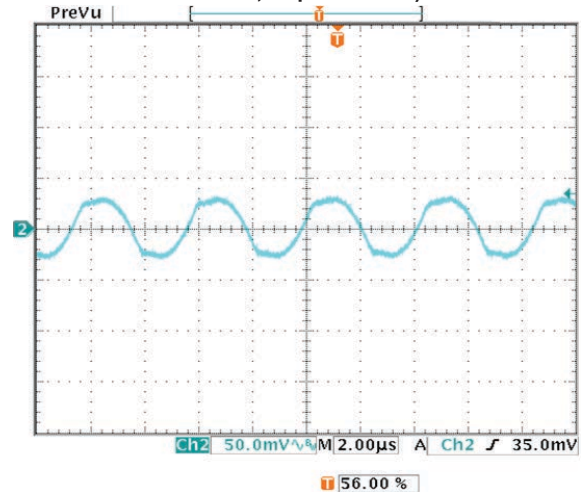

Output Ripple and Noise ($V_{in}=12V$, $V_{out}=nom$, $I_{out}=10A$, $C_{out}=1F \parallel 10\mu F$, $T_a=+25^\circ C$, ScopeBW=20Mhz)

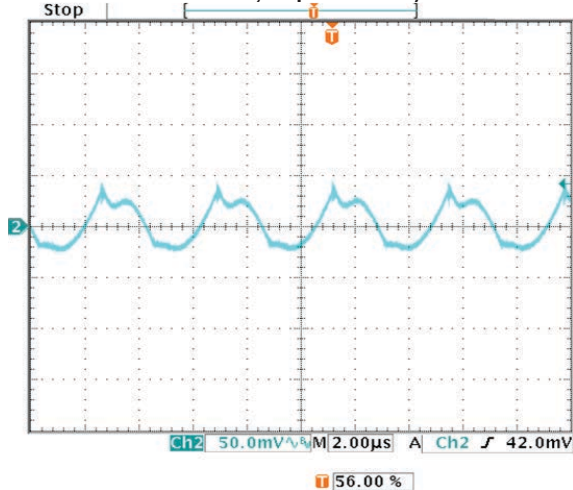

Output Ripple and Noise ($V_{in}=12V$, $V_{out}=nom$, $I_{out}=10A$, $C_{out}=1F \parallel 10\mu F \parallel 5000\mu F$, $T_a=+25^\circ C$, ScopeBW=20Mhz)

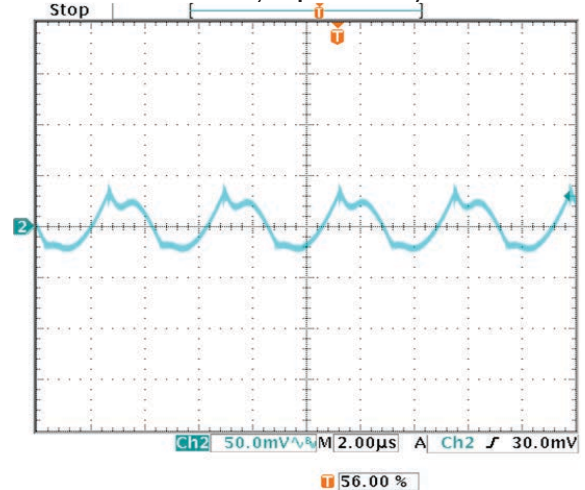

PERFORMANCE DATA, UWE-12/10-Q12

Thermal image with hot spot at 8.66A current with 25°C ambient temperature. Natural convection is used with no forced airflow. Identifiable and recommended maximum value to be verified in application. Vin=12V, Q6 is the hot spot.

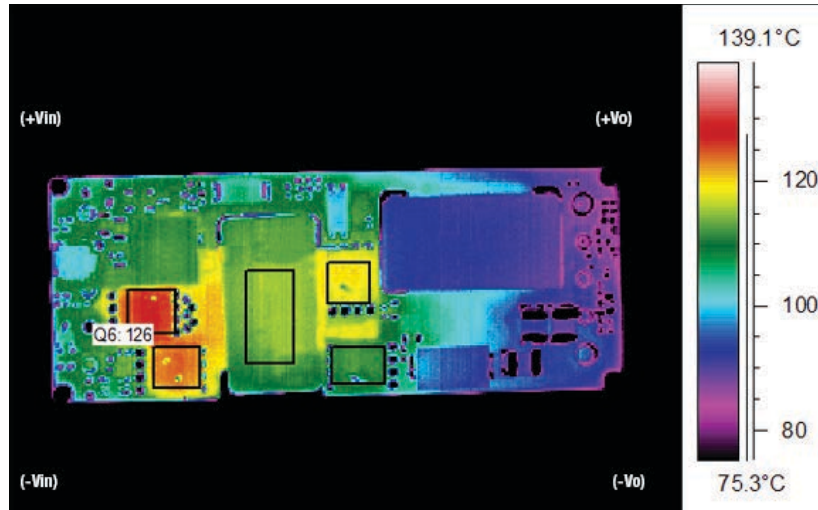

MECHANICAL SPECIFICATIONS—NO BASEPLATE

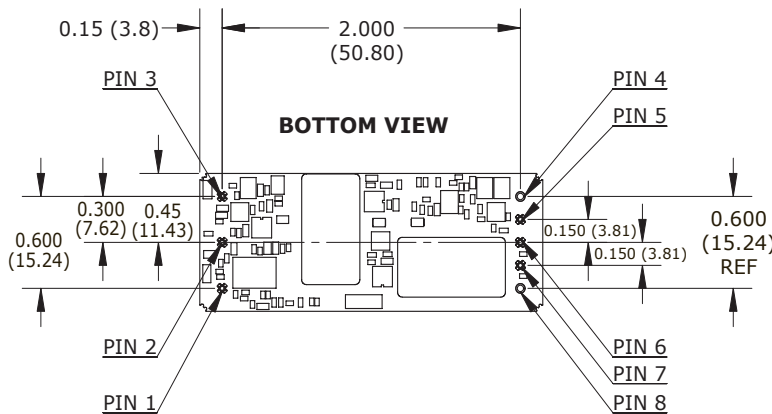
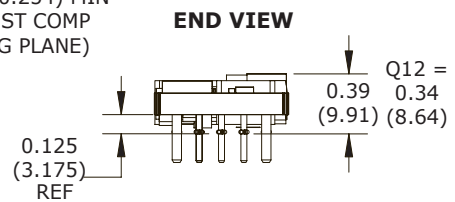
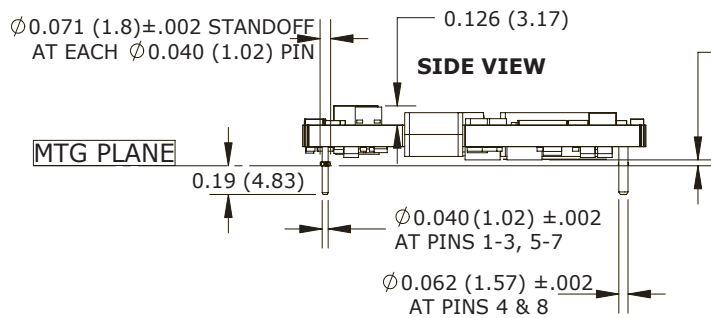
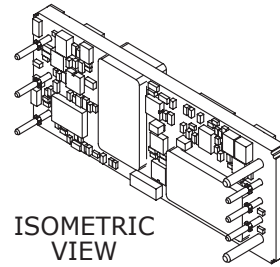
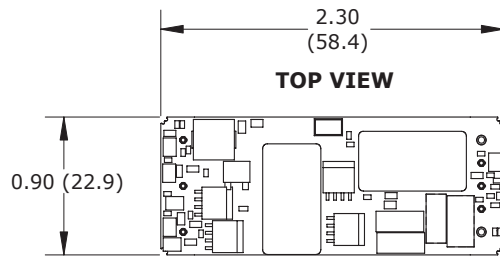

DOSA-Compatible I/O Connections	
Pin	Function
1	+Vin
2	On/Off Control*
3	-Vin
4	-Vout
5	-Sense
6	Trim
7	+Sense
8	+Vout

* The Remote On/Off can be provided with either positive (P suffix) or negative (N suffix) logic.

Connect each sense input to its respective Vout if sense is not connected at a remote load.

MATERIAL:
 $\phi .040$ PINS: C26000 BRASS, 3/4 HARD
 $\phi .062$ PINS: C10200 COPPER ALLOY, FULL HARD

FINISH: (ALL PINS)
 GOLD (5 MICROINCHES MIN) OVER NICKEL (50 MICROINCHES MIN)

Dimensions are in inches (mm shown for ref. only).

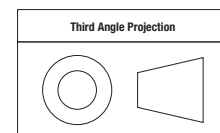

Tolerances (unless otherwise specified):
 .XX ± 0.02 (0.5)
 .XXX ± 0.010 (0.25)
 Angles $\pm 2^\circ$

Components are shown for reference only.

**RECOMMENDED FOOTPRINT
(VIEW THROUGH CONVERTER)**

REF: DOSA STANDARD SPECIFICATION
FOR EIGHTH BRICK DC/DC CONVERTERS

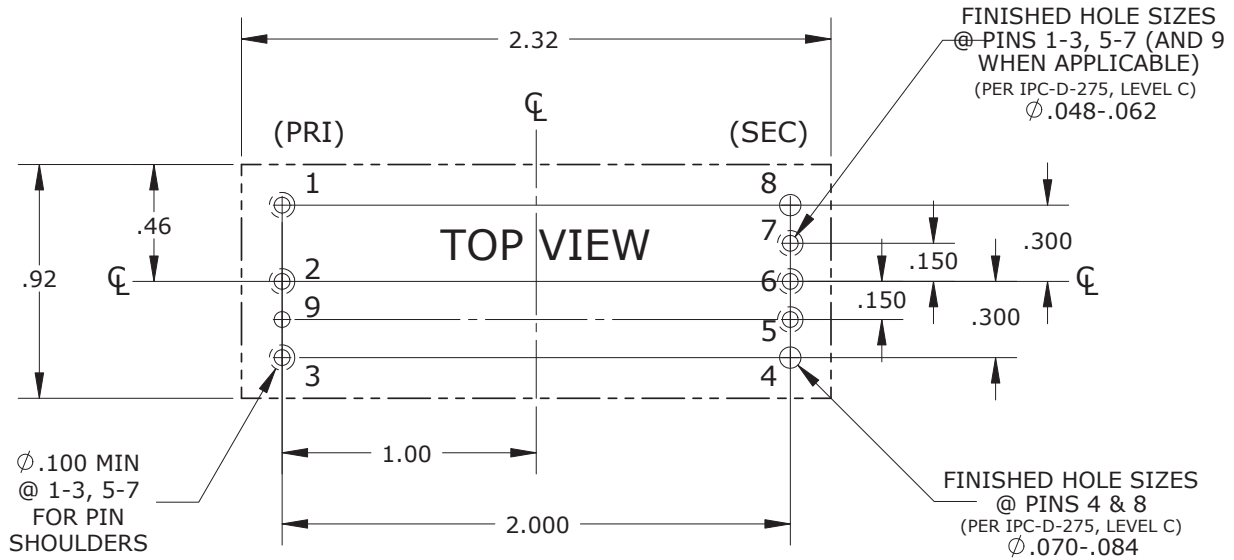

IT IS RECOMMENDED THAT NO PARTS
BE PLACED BENEATH CONVERTER

MECHANICAL SPECIFICATIONS (continued)—BASEPLATE INSTALLED

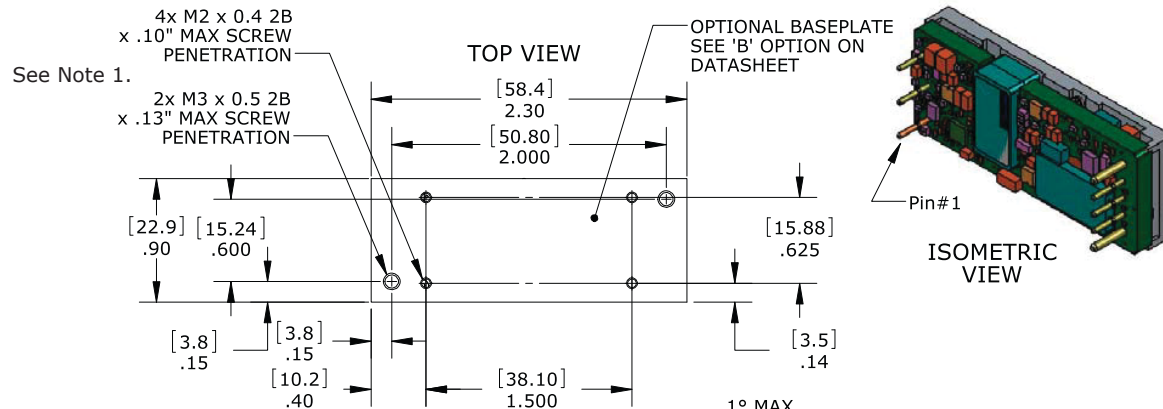

Note 1. The (2) M3 holes are not installed on the baseplate of the UWE-12/10-Q12xB-C.

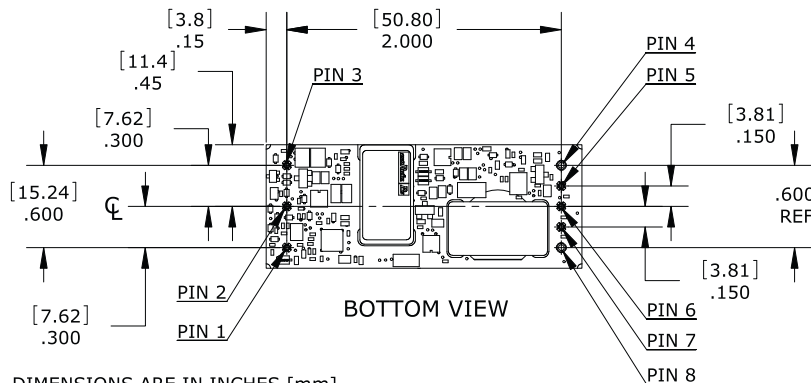
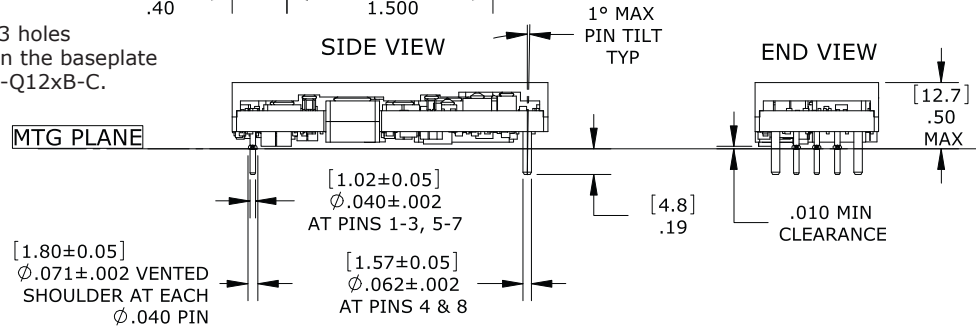

DIMENSIONS ARE IN INCHES [mm]

TOLERANCES:
 2 PLACE ±.02 [0.5] ANGLES: ±1°
 3 PLACE ±.010 [0.25]

COMPONENTS SHOWN ARE FOR REFERENCE ONLY

MATERIAL:
 Ø.040 PINS: COPPER ALLOY
 Ø.062 PINS: COPPER ALLOY

FINISH: (ALL PINS)
 GOLD (5u"MIN) OVER NICKEL (50u" MIN)

Dimensions are in inches (mm shown for ref. only).

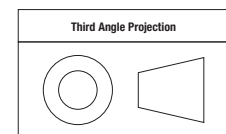

Tolerances (unless otherwise specified):
 .XX ± 0.02 (0.5)
 .XXX ± 0.010 (0.25)
 Angles ± 2°

Components are shown for reference only.

SHIPPING TRAYS AND BOXES

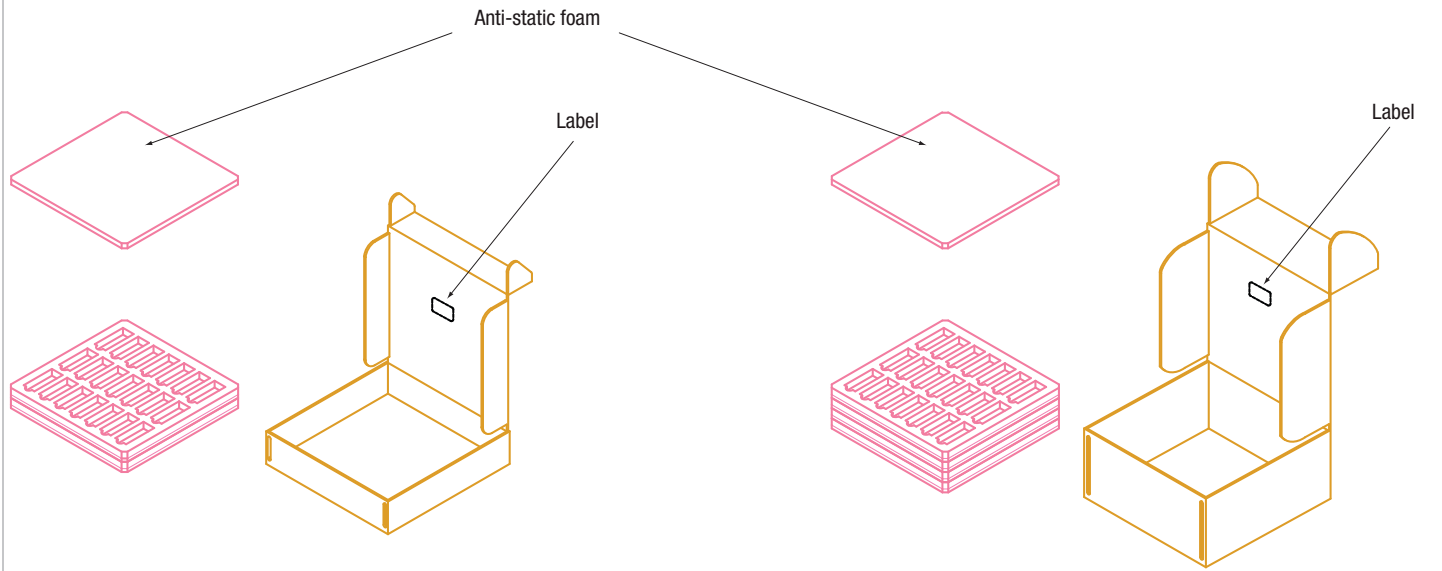

SHIPPING TRAY

UWE modules are supplied in a 21-piece (3-by-7) shipping tray. The tray is an anti-static closed-cell polyethylene foam. Dimensions are shown below.

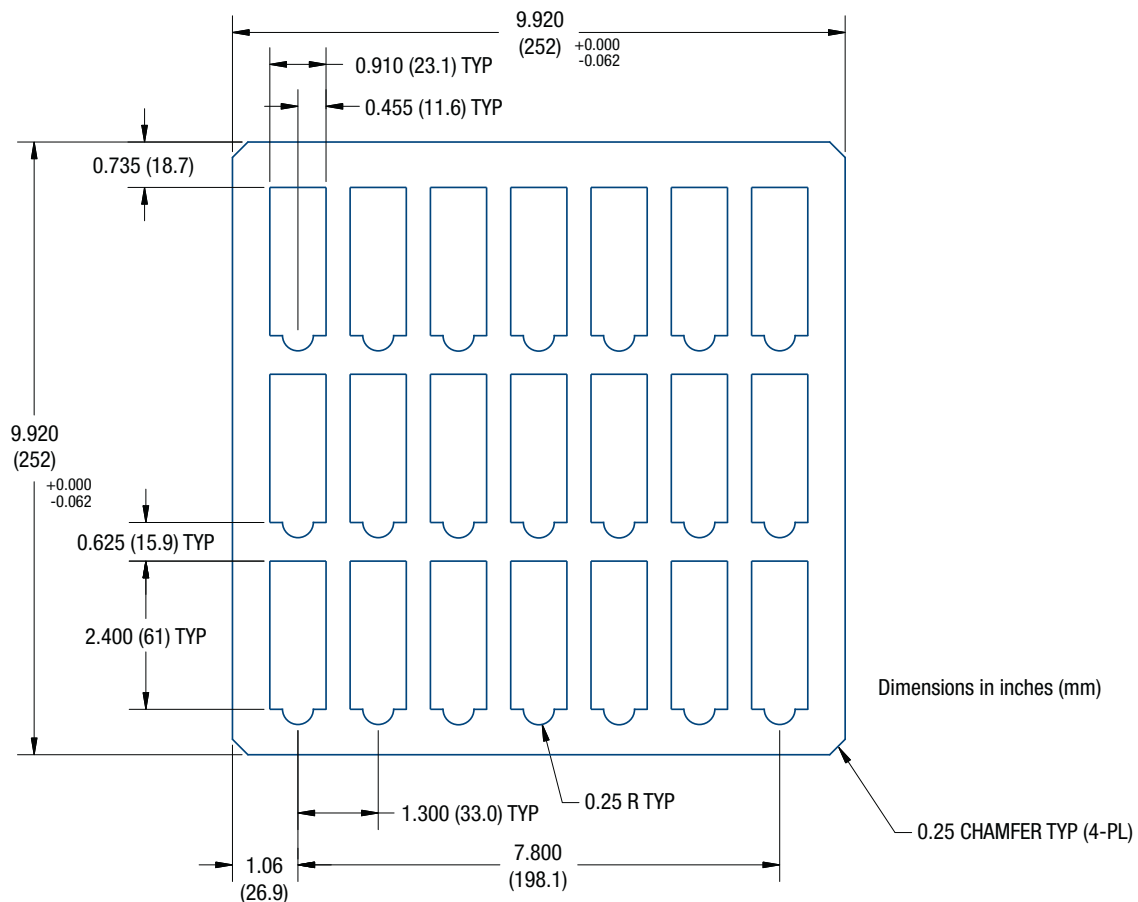

TECHNICAL NOTES

Input Fusing

Certain applications and/or safety agencies may require the installation of fuses at the inputs of power conversion components. Fuses should also be used if the possibility of sustained, non-current-limited, input-voltage polarity reversals exist. For MPS UWE DC-DC Converters, you should use fast-blow type fuses, installed in the ungrounded input supply line. Refer to the specifications for fuse values.

All relevant national and international safety standards and regulations must be observed by the installer. For system safety agency approvals, the converters must be installed in compliance with the requirements of the end-use safety standard, e.g., IEC/EN/UL60950-1.

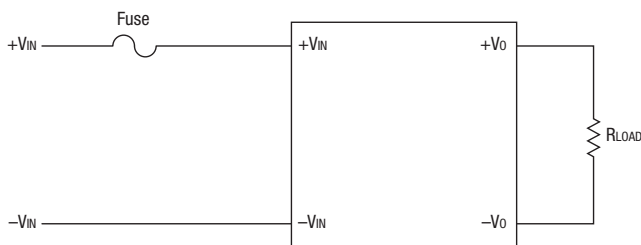

Figure 2. Input Fusing

Input Undervoltage Shutdown and Start-Up Threshold

Under normal start-up conditions, devices will not begin to regulate until the ramping-up input voltage exceeds the Start-Up Threshold Voltage. Once operating, devices will not turn off until the input voltage drops below the Undervoltage Shutdown limit. Subsequent re-start will not occur until the input is brought back up to the Start-Up Threshold. This built in hysteresis prevents any unstable on/off situations from occurring at a single input voltage.

Start-Up Time

The V_{IN} to V_{OUT} Start-Up Time is the interval of time between the point at which the ramping input voltage crosses the Start-Up Threshold and the fully loaded output voltage enters and remains within its specified accuracy band. Actual measured times will vary with input source impedance, external input/output capacitance, and load. The UWE Series implements a soft start circuit that limits the duty cycle of its PWM controller at power up, thereby limiting the input inrush current.

The On/Off Control to V_{OUT} start-up time assumes the converter has its nominal input voltage applied but is turned off via the On/Off Control pin. The specification defines the interval between the point at which the converter is turned on and the fully loaded output voltage enters and remains within its specified accuracy band. Similar to the V_{IN} to V_{OUT} start-up, the On/Off Control to V_{OUT} start-up time is also governed by the internal soft start circuitry and external load capacitance.

The difference in start up time from V_{IN} to V_{OUT} and from On/Off Control to V_{OUT} is therefore insignificant.

Input Source Impedance

UWE converters must be driven from a low ac-impedance input source. The DC-DC's performance and stability can be compromised by the use of highly inductive source impedances. For optimum performance, components should be mounted close to the DC-DC converter. If the application has a high source impedance, low V_{IN} models can benefit from increased external input capacitance.

I/O Filtering, Input Ripple Current, and Output Noise

All models in the UWE Converters are tested/specified for input reflected ripple current and output noise using the specified external input/output components/circuits and layout as shown in the following two figures.

External input capacitors (C_{IN} in Figure 3) serve primarily as energy-storage elements, minimizing line voltage variations caused by transient IR drops in conductors from backplane to the DC-DC. Input caps should be selected for bulk capacitance (at appropriate frequencies), low ESR, and high rms-ripple-current ratings. The switching nature of DC-DC converters requires that dc voltage sources have low ac impedance as highly inductive source impedance can affect system stability. In Figure 3, C_{BUS} and L_{BUS} simulate a typical dc voltage bus. Your specific system configuration may necessitate additional considerations.

In critical applications, output ripple/noise (also referred to as periodic and random deviations or PARD) may be reduced below specified limits using filtering techniques, the simplest of which is the installation of additional external output capacitors. These output caps function as true filter elements and should be selected for bulk capacitance, low ESR and appropriate frequency response. All external capacitors should have appropriate voltage and current ratings, and be located as close to the converter as possible. Temperature variations for all relevant parameters should also be taken carefully into consideration.

The most effective combination of external I/O capacitors will be a function of line voltage and source impedance, as well as particular load and layout conditions.

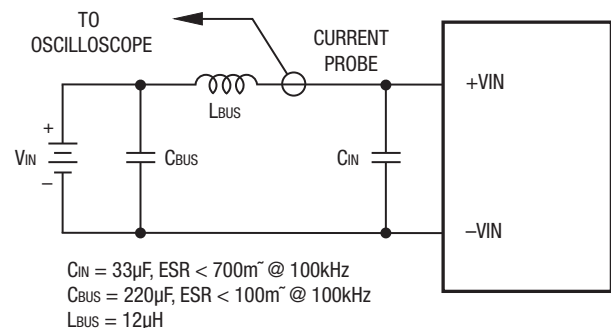

Figure 3. Measuring Input Ripple Current

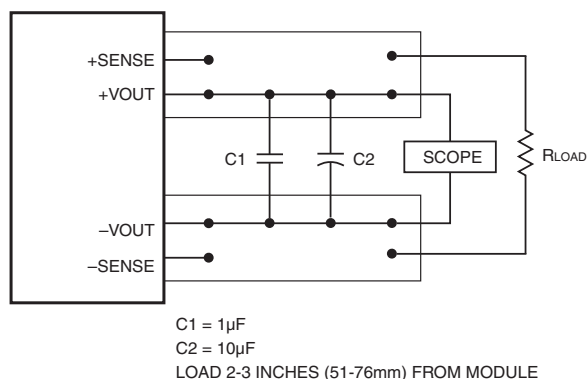

Figure 4. Measuring Output Ripple/Noise (PARD)

Floating Outputs

Since these are isolated DC-DC converters, their outputs are "floating" with respect to their inputs. Designers will normally use the -Output as the ground/return of the load circuit. You can, however, use the +Output as ground/return to effectively reverse the output polarity.

Minimum Output Loading Requirements

UWE converters employ a synchronous-rectifier design topology and all models regulate within spec and are stable under no-load to full load conditions. Operation under no-load conditions however might slightly increase the output ripple and noise.

Thermal Shutdown

These UWE converters are equipped with thermal-shutdown circuitry. If environmental conditions cause the internal temperature of the DC-DC converter to rise above the designed operating temperature, a precision temperature sensor will power down the unit. When the internal temperature decreases below the threshold of the temperature sensor, the unit will self start. See Performance/Functional Specifications.

Output Overvoltage Protection

UWE output voltages are monitored for an overvoltage condition via magnetic feedback. The signal is coupled to the primary side and if the output voltage rises to a level which could be damaging to the load, the sensing circuitry will power down the PWM controller causing the output voltages to decrease. Following a time-out period the PWM will restart, causing the output voltages to ramp to their appropriate values. If the fault condition persists, and the output voltages again climb to excessive levels, the overvoltage circuitry will initiate another shutdown cycle. This on/off cycling is referred to as "hiccup" mode.

Current Limiting

As soon as the output current increases to substantially above its rated value, the DC-DC converter will go into a current-limiting mode. In this condition, the output voltage will decrease proportionately with increases in output current, thereby maintaining somewhat constant power dissipation. This is commonly referred to as power limiting. Current limit inception is defined as the point at which the full-power output voltage falls below the specified tolerance. See Performance/Functional Specifications. If the load current, being drawn from the converter, is significant enough, the unit will go into a short circuit condition as specified under "Performance."

Short Circuit Condition

When a converter is in current-limit mode, the output voltage will drop as the output current demand increases. If the output voltage drops too low, the magnetically coupled voltage used to develop primary side voltages will also drop, thereby shutting down the PWM controller. Following a time-out period, the PWM will restart causing the output voltages to begin ramping to their appropriate values. If the short-circuit condition persists, another shutdown cycle will be initiated. This on/off cycling is referred to as "hiccup" mode. The hiccup cycling reduces the average output current, thereby preventing internal temperatures from rising to excessive levels. The UWE is capable of enduring an indefinite short circuit output condition.

Features and Options

On/Off Control

The input-side, remote On/Off Control function can be ordered to operate with either logic type:

Positive-logic models ("P" part-number suffix) are enabled when the On/Off Control is left open or is pulled high, as per Figure 5. Positive-logic devices are disabled when the On/Off Control is pulled low.

Negative-logic devices ("N" suffix) are off when the On/Off Control is open (or pulled high), and on when the On/Off Control is pulled low with respect to -VIN (see Figure 5).

Dynamic control of the remote on/off function is facilitated with a mechanical relay or an open-collector/open-drain drive circuit (optically isolated if appropriate). The drive circuit should be able to sink appropriate current (see Performance Specs) when activated and withstand appropriate voltage when deactivated.

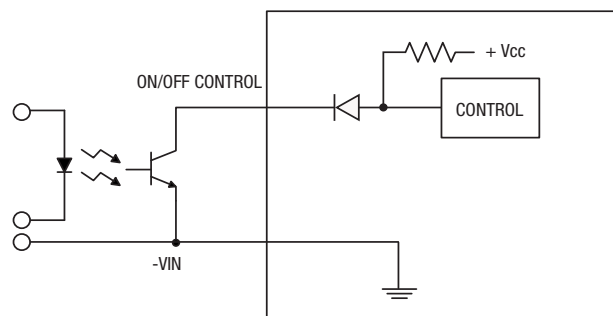

Figure 5. Driving the Logic On/Off Control Pin

Trimming Output Voltage

UWE converters have a trim capability that allows users to adjust the output voltages. Adjustments to the output voltages can be accomplished via a trim pot (Figure 6) or a single fixed resistor as shown in Figures 7 and 8. A single fixed resistor can increase or decrease the output voltage depending on its connection. The resistor should be located close to the converter and have a TCR less than 100ppm/°C to minimize sensitivity to changes in temperature. If the trim function is not used, leave the trim pin floating.

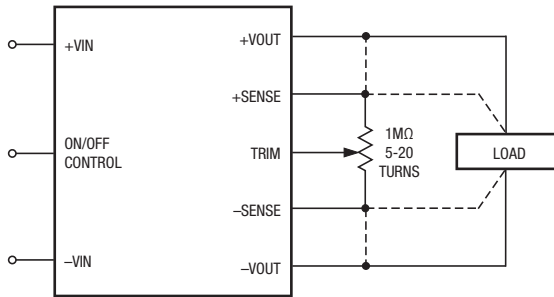

Figure 6. Trim Connections Using a Trimpot

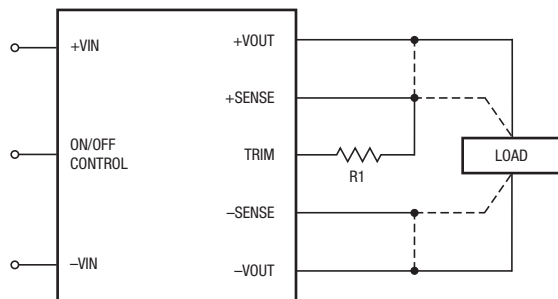

Figure 7. Trim Connections to Increase Output Voltages Using a Fixed Resistor

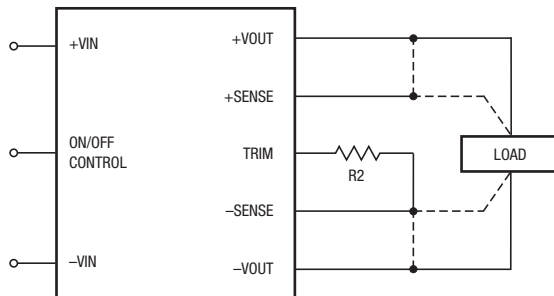

Figure 8. Trim Connections to Decrease Output Voltages

Trim Equations

Trim Up

Trim Down

3.3 Volt Output	
$R_{T_UP} (k\Omega) = \frac{13.3(V_O - 1.226)}{V_O - 3.3} - 10.2$	$R_{T_DOWN} (k\Omega) = \frac{16.31}{3.3 - V_O} - 10.2$
5 Volt Output	
$R_{T_UP} (k\Omega) = \frac{20.4(V_O - 1.226)}{V_O - 5} - 10.2$	$R_{T_DOWN} (k\Omega) = \frac{25.01}{5 - V_O} - 10.2$
12 Volt Output	
$R_{T_UP} (k\Omega) = \frac{49.6(V_O - 1.226)}{V_O - 12} - 10.2$	$R_{T_DOWN} (k\Omega) = \frac{60.45}{12 - V_O} - 10.2$

A single resistor connected from the Trim to the +Output, or +Sense where applicable, will increase the output voltage in this configuration. A resistor connected from the Trim to the -Output, or -Sense where applicable, will decrease the output voltage in this configuration.

Trim adjustments greater than the specified range can have an adverse affect on the converter's performance and are not recommended. Excessive voltage differences between V_{OUT} and Sense, in conjunction with trim adjustment of the output voltage, can cause the overvoltage protection circuitry to activate (see Performance Specifications for overvoltage limits). Power derating is based on maximum output current and voltage at the converter's output pins. Use of trim and sense functions can cause output voltages to increase, thereby increasing output power beyond the converter's specified rating or cause output voltages to climb into the output overvoltage region. Therefore:

$$(V_{OUT \text{ at pins}}) \times (I_{OUT}) \leq \text{rated output power}$$

Note: Resistor values are in $k\Omega$. Adjustment accuracy is subject to resistor tolerances and factory-adjusted output accuracy. V_O = desired output voltage.

Remote Sense Note

The Sense and V_{OUT} lines are internally connected through low value resistors. Nevertheless, if the sense function is not used for remote regulation the user should connect the +Sense to +V_{OUT} and –Sense to –V_{OUT} at the DC-DC converter pins.

UWE series converters have a sense feature to provide point of use regulation, thereby overcoming moderate IR drops in pcb conductors or cabling. The remote sense lines carry very little current and therefore require minimal cross-sectional-area conductors. The sense lines are used by the feedback control-loop to regulate the output. As such, they are not low impedance points and must be treated with care in layouts and cabling. Sense lines on a pcb should be run adjacent to dc signals, preferably ground. In cables and discrete wiring applications, twisted pair or other techniques should be implemented.

UWE series converters will compensate for drops between the output voltage at the DC-DC and the sense voltage at the DC-DC provided that:

$$[V_{out(+)} - V_{out(-)}] - [Sense(+)-Sense(-)] \leq 5\% V_{out}$$

Output overvoltage protection is monitored at the output voltage pin, not the Sense pin. Therefore, excessive voltage differences between V_{OUT} and Sense in conjunction with trim adjustment of the output voltage can cause the overvoltage protection circuitry to activate (see Performance Specifications for overvoltage limits). Power derating is based on maximum output current and voltage at the converter's output pins. Use of trim and sense functions can cause output voltages to increase thereby increasing output power beyond the UWE's specified rating or cause output voltages to climb into the output overvoltage region. Also, the use of Trim Up and Sense combined may not exceed +10% of V_{OUT}. Therefore, the designer must ensure:

$$(V_{out \text{ at pins}}) \times (I_{out}) \leq \text{rated output power}$$

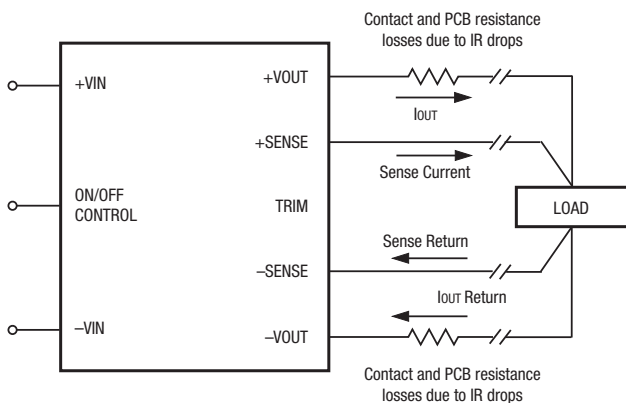

Figure 9. Remote Sense Circuit Configuration

Soldering Guidelines

Murata Power Solutions recommends the specifications below when installing these converters. These specifications vary depending on the solder type. Exceeding these specifications may cause damage to the product. Your production environment may differ; therefore please thoroughly review these guidelines with your process engineers.

Wave Solder Operations for through-hole mounted products (THMT)

For Sn/Ag/Cu based solders:

Maximum Preheat Temperature	115° C.
Maximum Pot Temperature	270° C.
Maximum Solder Dwell Time	7 seconds

For Sn/Pb based solders:

Maximum Preheat Temperature	105° C.
Maximum Pot Temperature	250° C.
Maximum Solder Dwell Time	6 seconds

Emissions Performance

The sample was tested in accordance with CISPR/EN55022 requirements. Class B limits were applied for this test. The EUT was supplied with 48Vdc (nominal) and was loaded to the maximum rating 120 Watts. The noise was measured on the return side of supply. The following EMI filter components were employed.

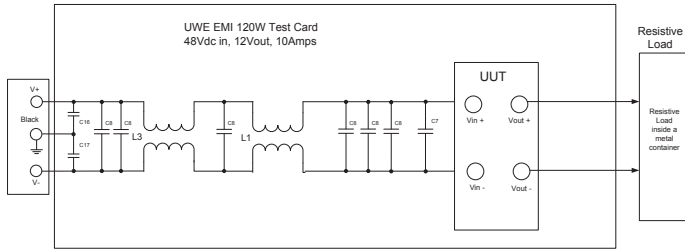

Figure 10. Conducted Emissions Test Circuit

[1] Conducted Emissions Parts List

REFERENCE	PART NUMBER	DESCRIPTION	VENDOR
L1	PE-62913	1mH, 6A	Pulse
L3	500µh,10A, MPS	500µh,10A	Murata
C1, C2, C8		2.2µFd	Murata
C7	VZ Series	Qty 2 - Electrolytic Capacitor 22µFd, 100V	Panasonic
C16, C17		.22µFd	Unknown

[2] Conducted Emissions Test Equipment Used

- Rohde & Schwarz EMI Test Receiver (9KHz – 1000MHz) ESPC
- Rohde & Schwarz Software ESPC-1 Ver. 2.20
- HP11947A Transient Limiter (Agilent)
- OHMITE 25W – Resistor combinations
- DC Source Programmable DC Power Supply Model 62012P-100-50[3]

Conducted Emissions Test Results (UWE-12/10-Q48)

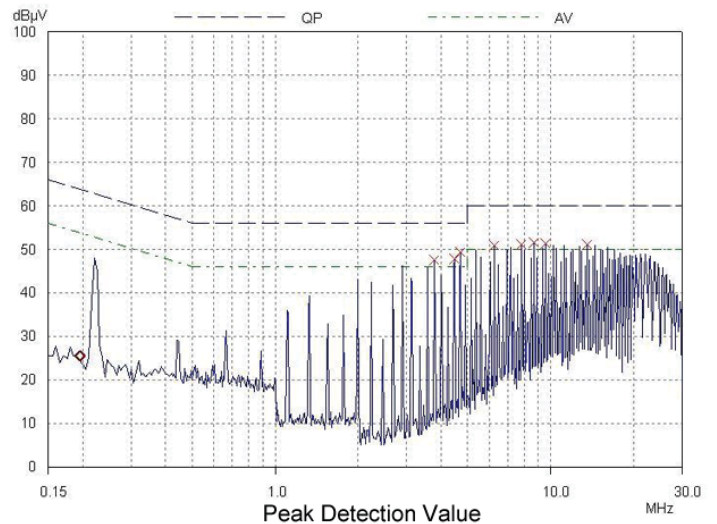

Graph 1. Conducted emissions performance, CISPR 22, Class B, full load

[4] Layout Recommendations

Most applications can use the filtering which is already installed inside the converter or with the addition of the recommended external capacitors. For greater emissions suppression, consider additional filter components and/or shielding. Emissions performance will depend on the user's PC board layout, the chassis shielding environment and choice of external components. Please refer to Application Note GEAN02 for further discussion.

Since many factors affect both the amplitude and spectra of emissions, we recommend using an engineer who is experienced at emissions suppression.

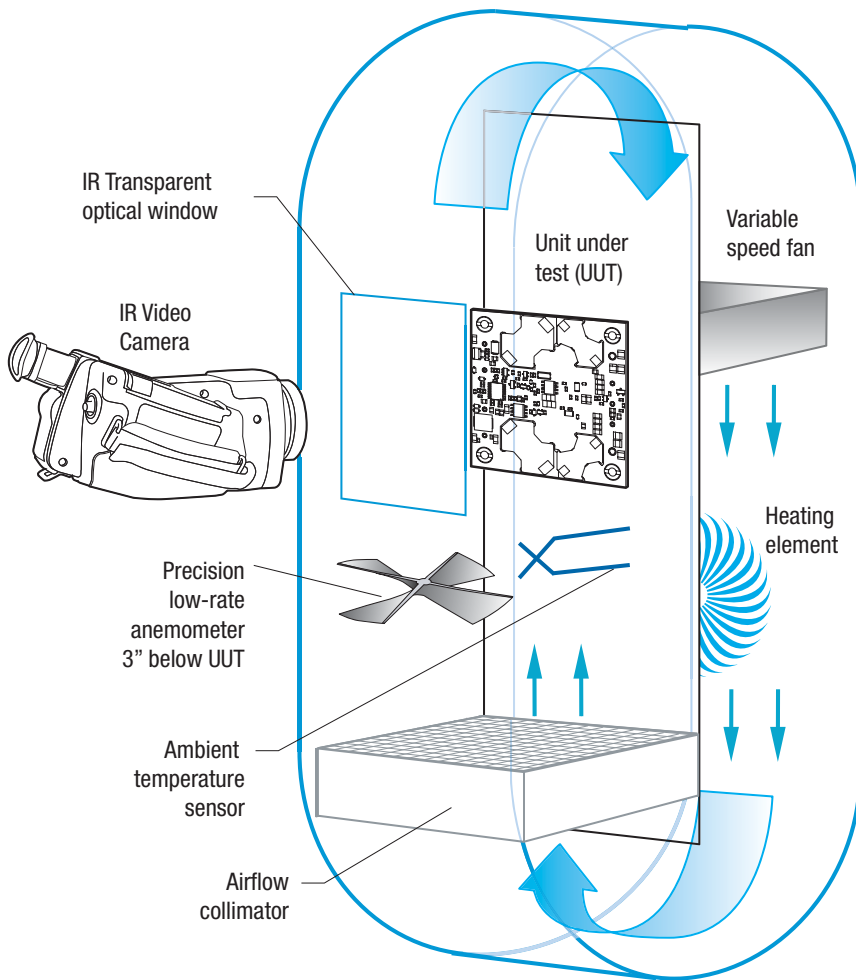

Figure 11. Vertical Wind Tunnel

Vertical Wind Tunnel

Murata Power Solutions employs a computer controlled custom-designed closed loop vertical wind tunnel, infrared video camera system, and test instrumentation for accurate airflow and temperature distribution measurements of power products. The system includes a precision low flow-rate anemometer, variable speed fan, power supply input and load controls, temperature gauges, and adjustable heating element.

The IR camera monitors the thermal performance of the Unit Under Test (UUT) under static steady-state conditions. A special optical port is used which is transparent to infrared wavelengths.

Both through-hole and surface mount converters are soldered down to a 10" x 10" host carrier board for realistic heat absorption and spreading. Both longitudinal and transverse airflow studies are possible by rotation of this carrier board since there are often significant differences in the heat dissipation in the two airflow directions. The combination of adjustable airflow, adjustable ambient heat, and adjustable Input/Output currents and voltages mean that a very wide range of measurement conditions can be studied.







The collimator reduces the amount of turbulence adjacent to the UUT by minimizing airflow turbulence. Such turbulence influences the effective heat transfer characteristics and gives false readings. Excess turbulence removes more heat from some surfaces and less heat from others, possibly causing uneven overheating.

Both sides of the UUT are studied since there are different thermal gradients on each side. The adjustable heating element and fan, built-in temperature gauges, and no-contact IR camera mean that power supplies are tested in real-world conditions.

Product model specific availability

MODEL NUMBER	PRODUCT STATUS	LTB DATE
UWE-12/10-Q48NB-C	In Production	N/A
UWE-12/10-Q48NBL1-C	Discontinued	3/31/2022
UWE-12/10-Q48NBL2-C	Discontinued	3/31/2022
UWE-12/10-Q48N-C	In Production	N/A
UWE-12/10-Q48NL1-C	Discontinued	3/31/2022
UWE-12/10-Q48NL2-C	Discontinued	3/31/2022
UWE-12/10-Q48PB-C	In Production	N/A
UWE-12/10-Q48P-C	Discontinued	3/31/2022
UWE-3.3/30-Q48NB-C	To be discontinued	3/31/2023
UWE-3.3/30-Q48NBL1-C	To be discontinued	3/31/2023
UWE-3.3/30-Q48N-C	To be discontinued	3/31/2023
UWE-3.3/30-Q48NL1-C	Discontinued	3/31/2022
UWE-3.3/30-Q48PB-C	To be discontinued	3/31/2023
UWE-3.3/30-Q48P-C	Discontinued	3/31/2022
UWE-5/20-Q48NB-C	To be discontinued	3/31/2023
UWE-5/20-Q48NBH-C	Discontinued	3/31/2022
UWE-5/20-Q48NBL2-C	In Production	N/A
UWE-5/20-Q48N-C	To be discontinued	3/31/2023
UWE-5/20-Q48PB-C	Discontinued	3/31/2022
UWE-5/20-Q48P-C	Discontinued	3/31/2022

Product Status ✕

	Products under development. Listed product specifications are subject to change without prior notice. Please contact us for sample availability and mass production schedule.
	Product is in mass production.
	Not recommended for new design.
	We are planning to discontinue production of this item. 'Last Time Buy' date or Discontinuation date may be shown on our web site. Before these dates, please contact us with your requirements.
	Production of this product has stopped.
	Murata particularly recommends this product for reasons of size and performance. Please contact Murata regarding pricing and delivery.
	This is a new product. Please contact Murata regarding pricing and delivery.

Link back to [part number structure](#)

Murata Power Solutions, Inc.
129 Flanders Road, Westborough, MA 01581 U.S.A.
ISO 9001 REGISTERED



This product is subject to the following operating requirements and the Life and Safety Critical Application Sales Policy: Refer to: <https://www.murata-ps.com/requirements/>

Murata Power Solutions, Inc. makes no representation that the use of its products in the circuits described herein, or the use of other technical information contained herein, will not infringe upon existing or future patent rights. The descriptions contained herein do not imply the granting of licenses to make, use, or sell equipment constructed in accordance therewith. Specifications are subject to change without notice.
© 2022 Murata Power Solutions, Inc.