

# Posistor® for over current protection PRG SERIES

BC-E0160J

## PRG18BB\*\*\*MB1RB SERIES

### 1. Part Numbering

ex) 

<b>PR</b>	<b>G</b>	<b>18</b>	<b>BB</b>	<b>330</b>	<b>M</b>	<b>B1</b>	<b>RB</b>
Product ID	Series	Dimensions	Temperature Characteristics	Resistance	Resistance Tolerance	Individual Specifications	Packaging

### 2. Ratings

Part Number	Charac.	Resistance (at 25°C)	Max. Voltage	*1 Max. Current	*2 Hold Current	*3 Trip Current
PRG18BB330MB1RB	BB C.P.100°C approx.	33ohm ±20%	DC 24 V	900mA	25mA(at +60°C) 36mA(at +25°C)	85mA(at -10°C) 71mA(at +25°C)
PRG18BB470MB1RB		47ohm ±20%		630mA	20mA(at +60°C) 29mA(at +25°C)	75mA(at -10°C) 61mA(at +25°C)
PRG18BB101MB1RB		100ohm ±20%		300mA	15mA(at +60°C) 21mA(at +25°C)	55mA(at -10°C) 45mA(at +25°C)
PRG18BB221MB1RB		220ohm ±20%		130mA	10mA(at +60°C) 14mA(at +25°C)	35mA(at -10°C) 29mA(at +25°C)
PRG18BB471MB1RB		470ohm ±20%		60mA	7mA(at +60°C)	25mA(at -10°C)
					10mA(at +25°C)	21mA(at +25°C)

Packaging Tape : Taping (Standard quantity is 4000pcs. Per reel)

- \*1 Shows the Maximum Current value which Shall be passed repeatedly when the circuit runs abnormally.
- \*2 Shows the Maximum Current value which Shall be passed continuously without tripping at 25°C and 60°C
- \*3 Shows the Trip Current value when Posistor® shall protect circuit from over load at -10°C and +25°C

### 3. Dimensions [mm]

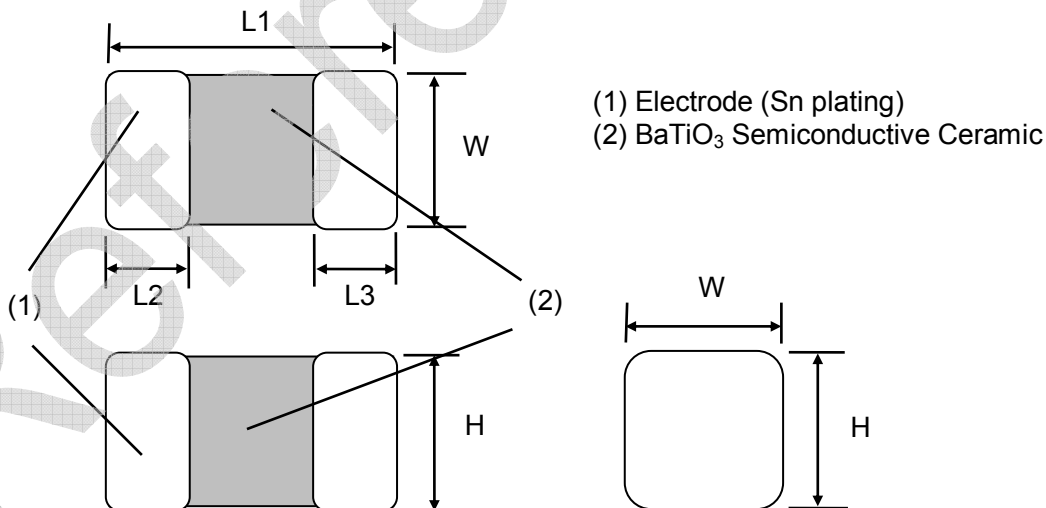

L1	W	H	L2 and L3
1.60±0.15	0.80±0.15	0.80±0.15	0.1~0.6

### 4. Quantity (Standard Quantity)

Products quantity in a reel
4,000 pcs. /reel

Resistance-Temperature Characteristics  
Typical Curve

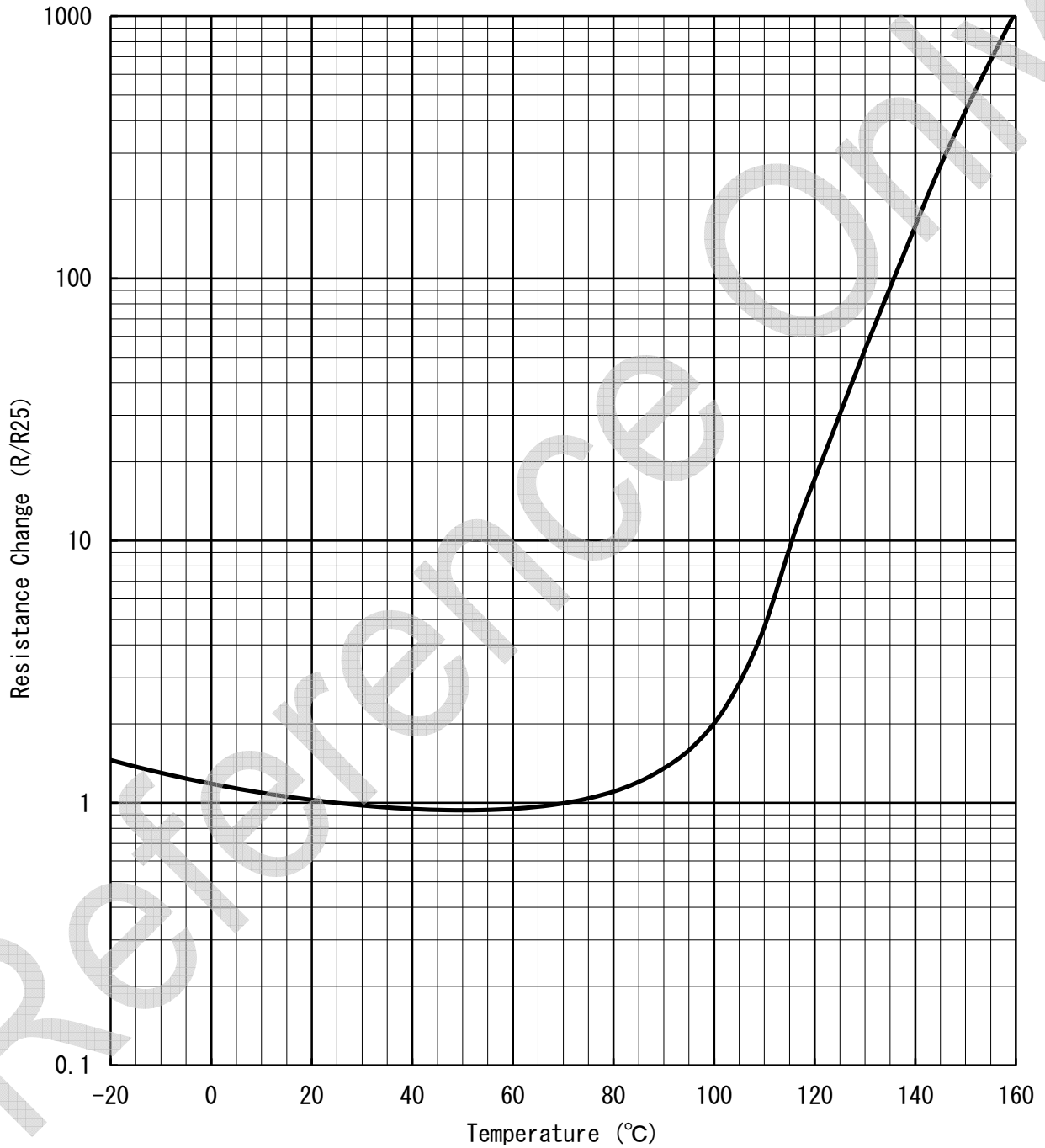

## Notice for use

### CAUTION

1. This product is designed for application, which is used under ordinary environment. (room temperature, normal humidity, normal pressure) Do not expose this to the following environments, because all these factors can deteriorate the characteristic of this and can cause failure or burn out.
  - (1) Corrosive gas or deoxidizing gases (Cl<sub>2</sub>, H<sub>2</sub>S, NH<sub>3</sub>, SO<sub>x</sub>, NO<sub>x</sub> etc.)
  - (2) Volatile, flammable gas
  - (3) Dusty place
  - (4) Place in a vacuum, reducing or putting pressure
  - (5) Place in splashed water, or high humidity and dewing place
  - (6) Salt water, oil, chemical liquid and solvent
  - (7) Vibratile place
  - (8) Other place equivalent to the above
2. Limitation of Applications  
Please contact us before using our products for the under-mentioned applications requiring especially high reliability in order to prevent defects which might directly cause damage to other party's life body or property (listed below).
  - (1) Aircraft equipment
  - (2) Aerospace equipment
  - (3) Undersea equipment
  - (4) Power plant control equipment
  - (5) Medical equipment
  - (6) Transportation equipment (automobiles, trains, ships, etc.)
  - (7) Traffic signal equipment
  - (8) Disaster prevention / Crime prevention equipment
  - (9) Data-processing equipment
  - (10) Applications of similar complexity or with reliability requirements comparable to the applications listed in the above
3. Be sure to provide an appropriate fail-safe function on your product to prevent a second damage that may be caused by the abnormal function or the failure of our product.

### Notice

1. Do not apply abnormal voltage/current exceeding the specified maximum value.  
Because they may deteriorate or destroy PTC element.
2. Use this product within the specified temperature. A higher temperature may deteriorate the characteristic or material.
3. The body of this product is not insulated. Please keep an adequate distance to surrounding components and wiring.
4. Storage conditions  
To keep solderability from declining, following storage condition is recommended.
  - (1) Condition    Temperature : -10 to +40°C  
                         Humidity        : Less than 75%RH (not dewing condition)
  - (2) Term: Please use this POSISTOR within 6 months after shipment by first-in and first-out stocking system.
  - (3) Handling after seal open: After unpacking of the minimum package, reseal it promptly or store it inside a sealed container with a drying agent.
  - (4) Place: Do not store this product in corrosive gas (SO<sub>x</sub>, Cl etc) or under sunlight.

5. Solder and Flux

(1) Solder Paste

Use Sn:Pb=60:40wt% ,Sn:Pb=63:37wt%, Sn:Ag:Cu=96.5:3.0:0.5wt% or equivalent type of solder paste.

Do not use strong acidic flux (with halide content exceeding 0.2wt%).

Use of the solder containing Zn may reduce adhesive strength.

When you use the solder containing Zn, please contact us in advance.

For your reference, we are using

'63Sn/37Pb RMA9086 90-3-M18', manufactured by Alpha Metals Japan Ltd.,

'96.5Sn/3.0Ag/0.5Cu M705-GRN360-K2-V', manufactured by Senju Metal Industry Co.,LTD.

for any Internal tests of this product.

(2) Flux

Use rosin type flux in soldering process.

If below flux is used, some problems might be caused in the product characteristics and reliability.

Please do not use below flux.

- Strong acidic flux (with halide content exceeding 0.2wt%).
- Water-soluble flux(\*Water-soluble flux can be defined as non rosin type flux including wash-type flux and non-wash-type flux.)

6. For removing the flux after soldering, observe the following points in order to avoid deterioration of the characteristics or any change of the external electrodes quality.

(1) Cleaning Conditions

Solvent	Dipping Cleaning	Ultrasonic Cleaning
2-propanol	Less than 5 min. at room temp. or Less than 2 min. at 40°C max.	Less than 1 min. 20W/L max. Frequency of several 10 kHz to several 100 kHz.

A sufficient cleaning shall be applied to remove flux completely.

(2) Drying : After cleaning, dry promptly this product.

7. In your mounting process, observe the following points in order to avoid deterioration of the characteristics or destruction of this product. The mounting quality of this product may also be affected by the mounting conditions, shown the points below.

This product is for only reflow soldering. Flow soldering shall not be allowed.

Please mount this product by soldering. When mounted by other methods, such as conductive adhesives, please contact us in advance.

(1) Standard Land Size

Too big land size gives too much solder paste on the land. It may cause destruction of this product, because of the mechanical stress especially in the case of board bending.

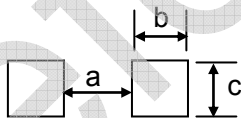

a	b	c
0.6~0.8	0.6~0.7	0.6~0.8

(mm)

(2) Printing Conditions of Solder Paste

i. Standard thickness of solder paste printing shall be from 0.15 to 0.20 mm.

ii. After soldering, the solder fillet shall be a height from 0.2 mm to the thickness of this product.

(See the figures below.)

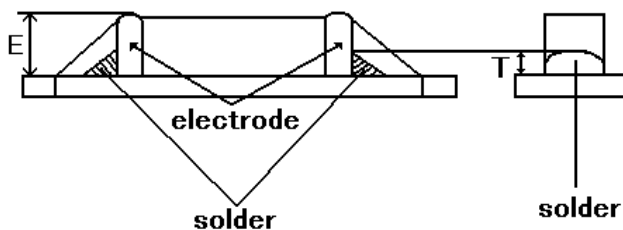

$$0.2\text{mm} \leq T \leq E$$

iii. Too much solder gives too strong mechanical stress to this product, such stress may cause cracking or any mechanical damage. And also, it can destroy the electrical performance of this product.

This information may be changed without a previous notice.

(3) Allowable Soldering Temperature and Time

- i. Solder within the temperature and time combinations, indicated by the slanted lines in the following graphs.
- ii. The excessive soldering conditions may cause dissolution of metallization or deterioration of solder-wetting on the external electrode.
- iii. In case of repeated soldering, the total accumulated soldering time should be within the range shown below figure. (For example, Reflow peak temperature : 250°C, twice → The total accumulated soldering time at 250°C is within 20sec.)

<Allowable Reflow Soldering Temp. and Time>

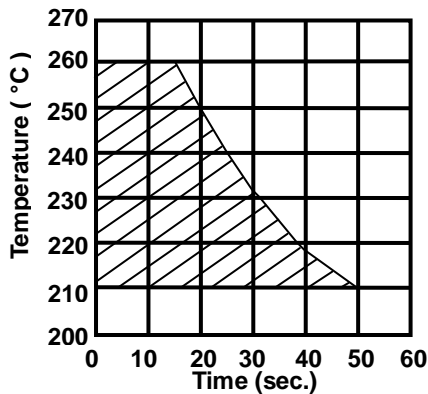

(4) Standard Temperature Profile for Soldering

- i. Insufficient preheating may cause a crack on ceramic body. Difference between preheating temperature and maximum temperature in the profile shall be 100°C.
- ii. Rapid cooling by dipping in solvent or by other means is not recommended.

<Reflow Soldering Condition>

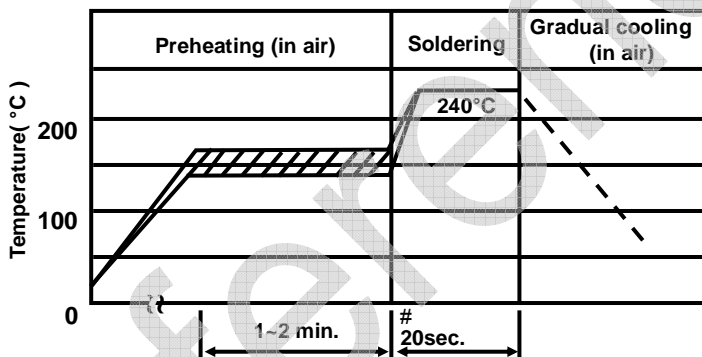

Preheating: 150 +/- 10 °C  
1min. to 2 min.  
Soldering: 240 °C  
20sec.

# : In case of repeated soldering, the total accumulated soldering time should be within the range shown above figure (3).

- (5) There is a fear of unexpected failures (tombstone, insufficient solder-wetting, etc.) in your mounting process, caused by the mounting conditions. Please evaluate if this product is correctly mounted under your mounting conditions.

(6) Conditions with Soldering Iron

When hand soldering by iron is applied, be sure to keep following conditions.

Item	Conditions
Preheating	at 150°C for 1 to 2 minute
Temperature of Iron-tip	350°C max.
Soldering Iron Wattage	30W max.
Diameter of Iron-tip	3mm dia. max.
Soldering Time	5sec. max.
Solder	H60A (Sn:Pb=60:40wt%) type , H63A (Sn:Pb=63:37wt%) type, Sn:Ag:Cu=96.5:3.0:0.5wt% or equivalent type.
Flux	Do not use strong acidic flux (with halide content exceeding 0.2wt%).
Caution	• Do not allow the iron-tip to directly touch the ceramic body. • Preheat the ceramic body and mounting board.

8. Do not give this product a strong press-force nor a mechanical shock.  
Because such mechanical forces may cause cracking or chipping of this ceramic product.
9. Rapid cooling or heating during soldering is not recommended.  
Such treatment may destroy the element.
10. When this product is operated, temperature of some area may be over 100 to 150°C. Be sure that surrounding parts and inserting material can withstand the temperature. If the surrounding part and material is kept under such condition, they may be deteriorated or may produce harmful gases (Cl<sub>2</sub>, H<sub>2</sub>S, NH<sub>3</sub>, SO<sub>x</sub>, NO<sub>x</sub> etc.). And, such harmful gas may deteriorate the element.
11. Do not assemble this product with air-sealing or resin casting. Such sealing may deteriorate the characteristic or destroy PTC element.
12. Location on Printed Circuit Board(PC Board)

<Component Direction>

Locate this product horizontal to the direction in which stress acts.

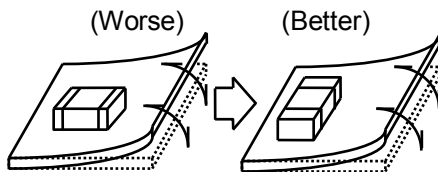

<Mounting Close to Board Separation Line>

Put this product on the PC Board near the Slit, not near the Perforation Holes.

Keep this product on the PC Board away from the Separation Line.

