

FEATURES

- UL62368-1 recognized
- EN62368-1 certified
- IEC61558-1 certified
- ANSI/AAMI ES60601-1, 1 MOPP/2 MOOP's recognition pending
- Wide input voltage range 85-305VAC/70-400VDC
- Operating temperature range -40°C to 85°C
- 4kVAC isolation 'Hi Pot Test'
- 5V, 12V & 24V single regulated outputs
- Short circuit protection
- No optocoupler
- Low standby power

PRODUCT OVERVIEW

The BAC1 series is the first series release from the BAC family of board mount AC/DC converters. The BAC1 series operates over the wide industrial temperature range of -40°C to +85°C, supporting operation in still air for the most demanding environments. Models are capable of operation to 85°C, and operate from -40°C. The BAC1 has ultra low standby power consumption for demanding energy and cost saving applications.



SELECTION GUIDE

Order Code	Output Power W	Output Voltage V	Output Current A	Ripple & Noise				Efficiency						Isolation Capacitance		MTTF ¹	
				115V & 230V		277V		115V		230V		277V		pF	MIL 217	Telcordia	
				Typ.	Max.	Typ.	Max.	Min.	Typ.	Min.	Typ.	Min.	Typ.				
				mVp-p				%									kHrs
BAC1S05SC	1	5	0.2	50	120	50	120	70	74	69	73	67	71	11	1613	38213	
BAC1S12SC	1	12	0.083	60	120	60	130	70	74	69	73	68	72	11	2038	44328	
BAC1S24SC	1	24	0.042	85	120	100	150	68	73	67	71	64	69	11	1816	40463	

INPUT CHARACTERISTICS

Parameter	Conditions	Min.	Typ.	Max.	Units
Voltage range	All input types	85	115/230/277	305	VAC
	All input types	70		400	VDC
Input frequency		47	50/60	63	Hz
Switching frequency	Nominal Vin = 115VAC		50		kHz
	Nominal Vin = 115VAC 24Vin		35		
	Nominal Vin = 230VAC/277VAC		40		
	Nominal Vin = 230VAC/277VAC 24Vin		25		
Input current	Nominal Vin = 115VAC		25		mA
	Nominal Vin = 230VAC		17		
	Nominal Vin = 277VAC		16		
Inrush current	Nominal Vin = 115VAC		6		A
	Nominal Vin = 230VAC & 277VAC		9		
Input leakage current	230VAC		1		µA
Stand by power	BAC1S05SC	115VAC		20	mW
		230VAC		61	
		277VAC		85	
	BAC1S12SC	115VAC		58	
		230VAC		68	
		277VAC		92	
	BAC1S24SC	115VAC		26	
		230VAC		81	
		277VAC		117	

ISOLATION CHARACTERISTICS

Parameter	Conditions	Min.	Typ.	Max.	Units
Isolation test voltage	Production tested for 1 seconds	4000			VAC
	Qualification tested for 1 minute	4000			
Resistance	Viso = 1000VDC	100			MΩ

1. Calculated using MIL-HDBK-217F FN2 and Telcordia SR-332 calculation model at T_A=25°C with nominal input voltage at full load. All specifications typical at T_A=25°C, nominal input voltage, rated output current and recommended components unless otherwise specified.

OUTPUT CHARACTERISTICS					
Parameter	Conditions	Min.	Typ.	Max.	Units
Minimum load		5			%
Initial voltage accuracy	5V output types			±5	%
	All other output types			±4	
Line regulation	Low line to high line	5V output types		±0.3	%
		All other output types		±0.1	
Load Regulation	5% total load to 100% total load		±0.2	±1.5	%
Total regulation	Includes line, load, temperature and drift			±5	%
Temperature coefficient				0.05	%/°C
Transient Response	Peak deviation - Single Output (50-75% & 75-50% swing)	BAC1S05SC		±4	%Vout
		BAC1S12SC		±3	
		BAC1S24SC		±2	
	Settling time (within 1% Vout Nom.)	24V output type		8	ms
All other output types		6			
Current limit inception	Auto-recovery	115VAC & 230VAC		150	%
		277VAC		150	
Hold up time	From power fail	115VAC		50	ms
		230VAC		240	
		277VAC		380	

TEMPERATURE CHARACTERISTICS					
Parameter	Conditions	Min.	Typ.	Max.	Units
Operation	Sealed box with no air flow	-40		85	°C
Storage		-40		125	
Product temperature rise above ambient				16	

ABSOLUTE MAXIMUM RATINGS	
Short-circuit protection	Continuous
Input voltage Vin	310VAC
Wave solder	Wave Solder profile not to exceed the profile recommended in IEC 61760-1 Section 6.1.3. Please refer to application notes for further information.
Lead temperature 1.0mm from case for 7 seconds (to JEDEC JESD22-B106)	270°C

TECHNICAL NOTES

ISOLATION VOLTAGE

'Hi Pot Test', 'Flash Tested', 'Withstand Voltage', 'Proof Voltage', 'Dielectric Withstand Voltage' & 'Isolation Test Voltage' are all terms that relate to the same thing, a test voltage, applied for a specified time, across a component designed to provide electrical isolation, to verify the integrity of that isolation.

Murata Power Solutions BAC1 series of AC-DC converters are all 100% production tested at their stated isolation voltage. This is 4kVAC for 3 seconds.

A question commonly asked is, "What is the continuous voltage that can be applied across the part in normal operation?"

The BAC1 series has been recognized by Underwriters Laboratory to 277VAC for Reinforced Insulation.

The BAC1 series has been certified by Demko to 277VAC for Reinforced Insulation.

REPEATED HIGH-VOLTAGE ISOLATION TESTING

It is well known that repeated high-voltage isolation testing of a barrier component can actually degrade isolation capability, to a lesser or greater degree depending on materials, construction and environment. We therefore strongly advise against repeated high voltage isolation testing, but if it is absolutely required, that the voltage be reduced by 20% from specified test voltage.

SAFETY APPROVAL

ANSI/AAMI ES60601-1

The BAC1 series is pending recognition by Underwriters Laboratory (UL) to ANSI/AAMI ES60601-1 and provides 2 MOOP (Means Of Operator Protection) and 1 MOPP (means of patient protection) based upon a working voltage of 277VAC max., between Primary and Secondary. File number E202895 applies.

EN62368-1

The BAC1 series has been certified by Demko (D) to EN62368 for reinforced insulation to a working voltage of 277VAC. Certificate number D-07177 applies.

UL62368-1

The BAC1 series has been recognized by Underwriters Laboratory (UL) to UL62368 for reinforced insulation to a working voltage of 277VAC. File number E151252 applies.

Creepage 8.3mm and clearance 6.6mm

Working altitude OVC II 5000m

FUSING

As stated in the application notes, to meet datasheet specifications it is required that a 1W 10Ω fusible resistor is fitted.

IEC61558-1

The BAC1 series has been certified by TUV SUD to IEC61558-1.

Input 100-240VAC, 50-60Hz; 0.03A;

Output 5-24VDC; 0.2-0.042A; 1W.

Maximum ambient of 70°C

Working altitude OVC II 5000m

Up to 5000m



Fuse: 100mA, Time-lag T

RoHS COMPLIANCE INFORMATION



This series is compatible with RoHS soldering systems with a peak wave solder temperature of 260°C for 10 seconds based on IEC 61760-1. Please refer to [application notes](#) for further information. The pin termination finish on this product series is Hot Dipped over Matte Tin with Nickel Preplate. The series is backward compatible with Sn/Pb soldering systems. For further information, please visit www.murata-ps.com/rohs

ENVIRONMENTAL VALIDATION TESTING

The following tests have been conducted on this product series, please contact Murata if further information about the tests is required.

Test	Standard	Condition
Temperature Cycling	JEDEC JESD22-A104	200 cycles. -40°C to 105°C, 15 minutes hold at each extreme.
HAST (Unbiased)	JEDEC JESD22-A118	96Hrs +2/-0Hrs at 130°C ± 2°C, 85% ± 5% R.H.
Storage Life	JEDEC JESD22-A103, Condition A	125°C +10/-0°C for ≥1000 hours
Vibration	BS EN 61373 with respect to BS EN 60068-2-64 2008, Test Fh Category 1 Class B	5 – 150Hz. Level at each axis – Vertical, Traverse and Longitudinal: 5.72m/s ² rms. 5 hours in each axis. Crest factor: 3 Sigma. Device is secured via pins/leads.
Shock	BS EN 61373: 2010, Category 1 Class B	Test is 30ms duration, 3 shocks in each sense of 3 mutually perpendicular axes (18 shocks total). Level at each axis as follows: Vertical, Traverse and Longitudinal: 50m/s ² . Device is secured via pins/leads.
Solderability	IPC/ECA J-STD-002, Test A1	Parts are baked for 4 hours at a temperature off 155°C, within 72 hours they are dipped in flux for 10 seconds. Followed by dipping the parts in a solder pot at 255°C ±5°C for 5 seconds (96SC tin/silver/copper)
Solvent cleaning	Resistance to cleaning agents.	Solvent – Novec 71IPA & Topklean EL-20A. Pulsed ultrasonic immersion 45°C- 65°C
Solvent resistance	MIL-STD-883, Method 2015	The parts and the bristle portion of the brush are immersed in Isopropanol for a minimum of 1 minute. The parts are brushed 3 times, after the third time the parts are blown dry and inspected.
Solder Heat	JEDEC JESD22-B106	The test sample is subjected to a molten solder bath at 270 ±5°C for 7 +2/-0 seconds (96SC tin/silver/copper). The leads are dipped in the solder bath to within 1mm of the device body.
Solder Heat (Hand)	MIL-STD 202, Method 210, Condition A	The soldering iron is heated to 350°C ± 10°C and applied to the terminations for a duration of 4 to 5 seconds.
Lead Integrity (Adhesion)	MIL-STD 883, Method 2025	Leads are bent through 90° until a fracture occurs.
Lead Integrity (Fatigue)	MIL-STD 883, Method 2004, Condition B ₁	The leads are bent to an angle of 15°. Each lead is subjected to 3 cycles.
Lead Integrity (Tension/Pull)	MIL-STD 883, Method 2004, Condition A	Pull of 0.227kg applied for 30 seconds. The force is then increased until the pins snap.

EMC STANDARDS

Conducted input noise	EN55032, Class B with external X cap
Radiated noise	EN55032, Class B
ESD immunity	IEC/EN61000-4-2 level 3 perf criteria A
Conducted transient immunity	EN61000-4-6, 10 Vrms, perf criteria A
Conducted surge immunity	EN61000-4-5, Installation class 3, perf criteria A
EFT/Burst	EN61000-4-4, level 3, perf criteria A
Radiated field immunity	EN61000-4-3, 10 V/m, perf criteria A
Dips and interruptions	EN61000-4-11, 100% reduction for 20ms (A), 60% reduction for 200ms (A), 30% reduction for 500ms (A), 100% reduction for 5s (B)
Magnetic fields	EN61000-4-8 30A/m, perf criteria A

PART NUMBER STRUCTURE

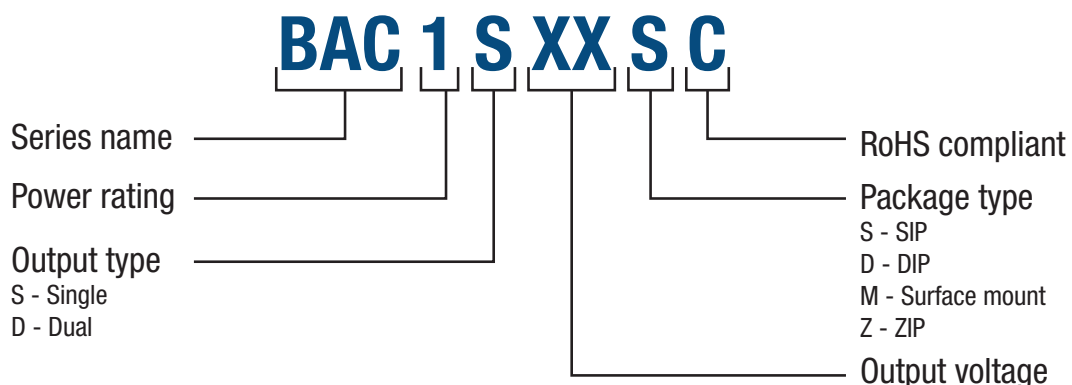

APPLICATION NOTES

Components required to meet datasheet specifications - 5V output types

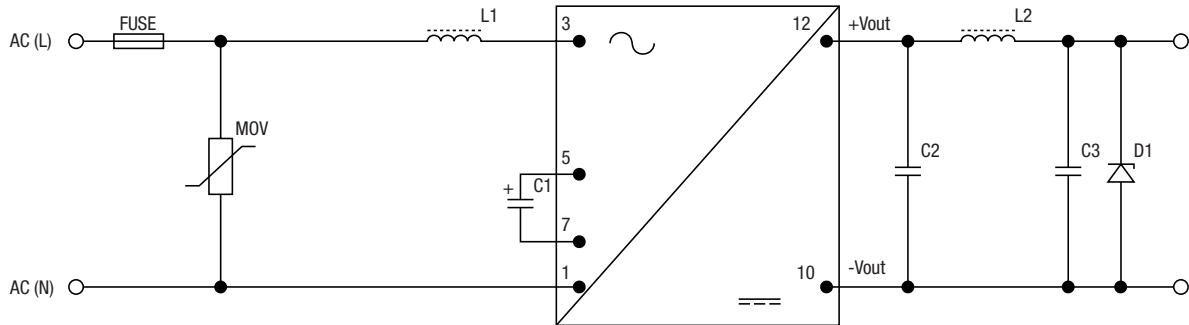

FUSE	1W 10Ω fusible resistor
MOV	Component fitted for compliance with EN61000-4-5, Installation class 3, perf criteria A
L1	330μH
C1	6.8μF 400V
C2	68μF 20mΩ low ESR polymer
L2	6.8μH 84682C
C3	22μF
D1	SMBJ7.0A transient voltage suppressor - component fitted for overshoot protection

Components required to meet datasheet specifications - 12V output types

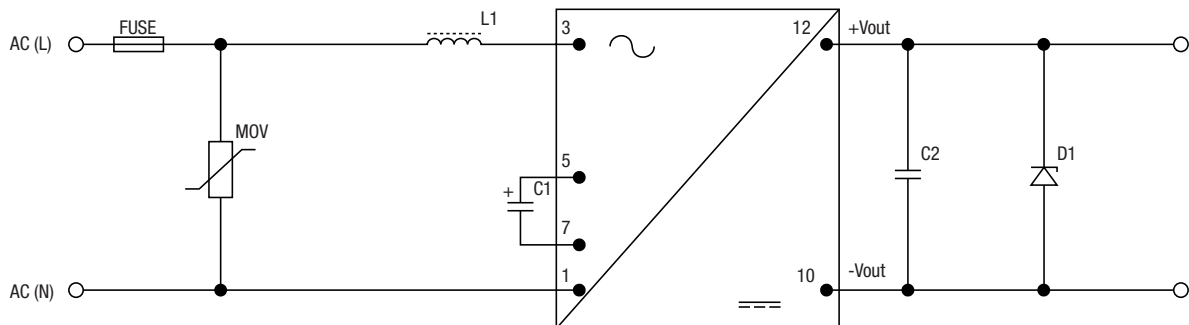

FUSE	1W 10Ω fusible resistor
MOV	Component fitted for compliance with EN61000-4-5, Installation class 3, perf criteria A
L1	330μH
C1	6.8μF 400V
C2	68μF 20mΩ low ESR polymer
D1	SMBJ20A transient voltage suppressor - component fitted for overshoot protection

APPLICATION NOTES (Continued)

Components required to meet datasheet specifications - 24V output types

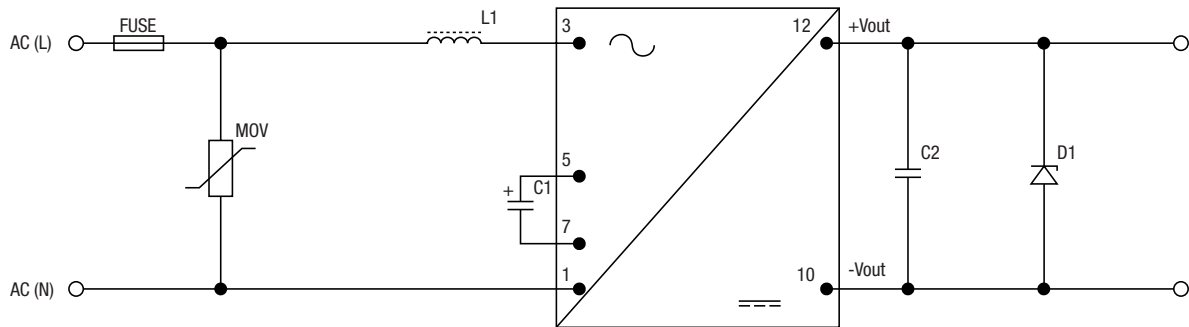

FUSE	1W 10Ω fusible resistor
MOV	Component fitted for compliance with EN61000-4-5, Installation class 3, perf criteria A
L1	330μH
C1	6.8μF 400V
C2	47μF 25mΩ low ESR polymer
D1	SMBJ30A transient voltage suppressor - component fitted for overshoot protection

Advisory Notes

The BAC1 series is not hermetically sealed, customers should ensure that parts are fully dried before input power application.

Output Capacitance and start-up times

The recommended specified caps on page 4 and 5 can already meet datasheet specification, there is no need to add extra caps. However, if customers connects to load capacitance, the below load capacitance are max (additional to recommended specified caps) to ensure start up at minimum AC input.

Part No.	Maximum Load Capacitance (per output)	Start-up times (AC input)	Start-up times (DC input)
	μF	s	s
BAC1S05SC	220	0.5	5
BAC1S12SC	100	1	5
BAC1S24SC	100	1	5

Minimum Load

The minimum load to meet full datasheet specification is 5% of the full rated load across the specified input voltage range.

24V output type - minimum input voltage requirements

At -40C the part is guaranteed to start into 100% load with a minimum input voltage of 115Vac; once the product is operating, the product will continue to operate at lower input voltages with higher output loading.

The product will start at -40C with 80% or lower load with an input voltage of 100VAC; once the product is operating, the product will continue to operate at lower input voltages with higher output loading.

CHARACTERISATION TEST METHODS

Ripple & Noise Characterisation Method

Ripple and noise measurements are performed with the following test configuration.

C1 10 μ F electrolytic capacitor

Differential Mode Noise Test Schematic

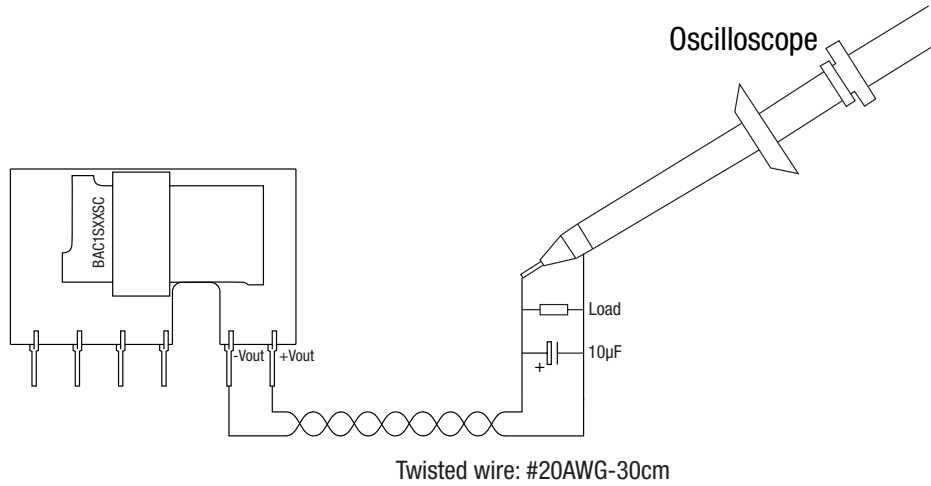

EFFICIENCY VS LOAD

BAC1S05DC

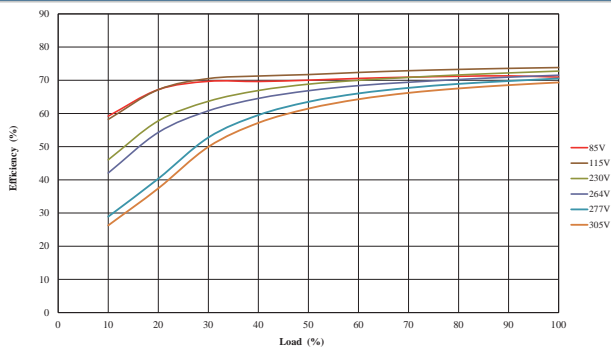

BAC1S12DC

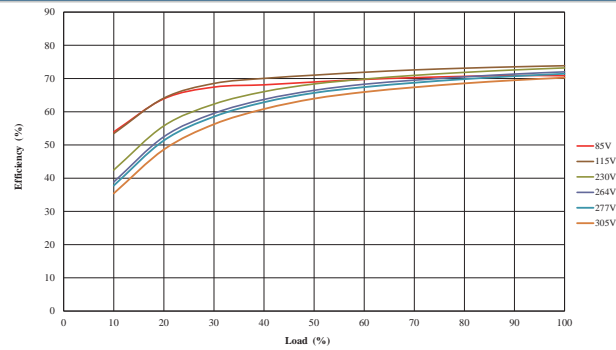

BAC1S24DC

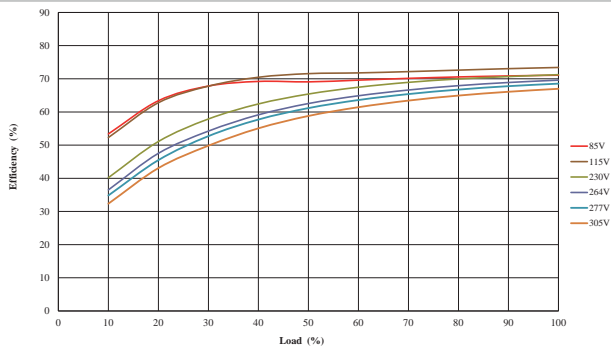

TEMPERATURE DERATING

BAC1S05DC

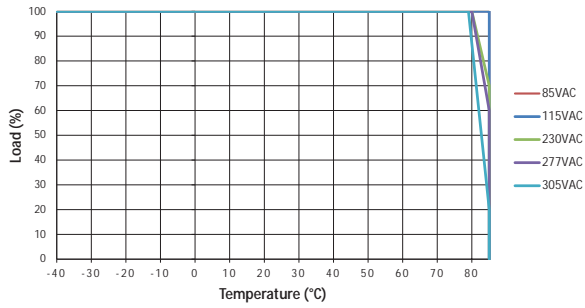

BAC1S12DC

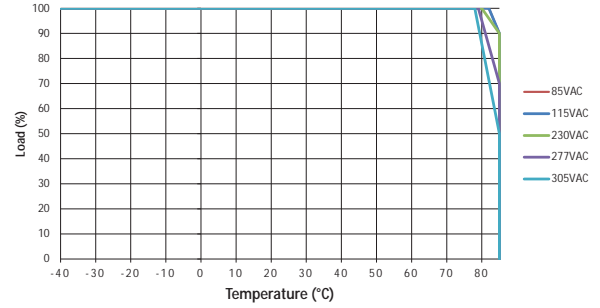

BAC1S24DC

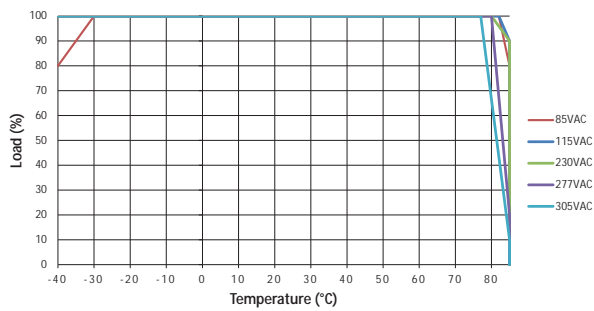

EMC FILTERING AND SPECTRA

FILTERING

The following filter circuit and filter table shows the input filters typically required to meet EN55032 Quasi-Peak (green line) Curve B limit vs peak conducted emissions.

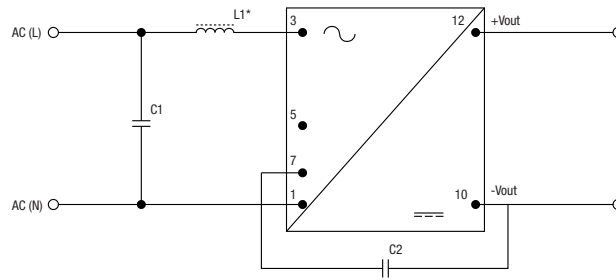

5V and 12V output types

Component	Description
C1	68nF 305VAC
L1	refer to "components required to match datasheet specifications"
C2	100pF Y-cap

Components marked with an asterisk are already fitted and should not be duplicated

BAC1S05SC (110V) - Live

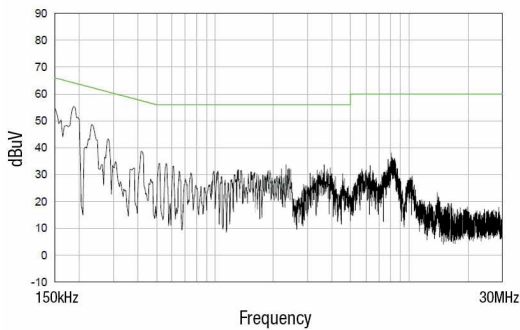

BAC1S05SC (110V) - Neutral

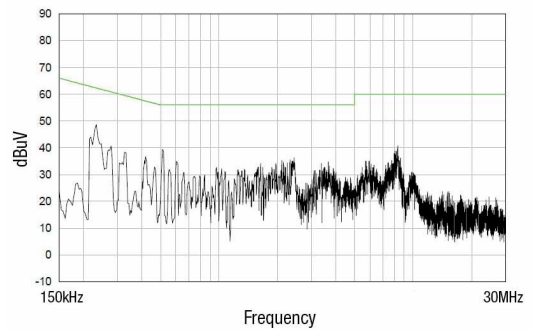

BAC1S12SC (110V) - Live

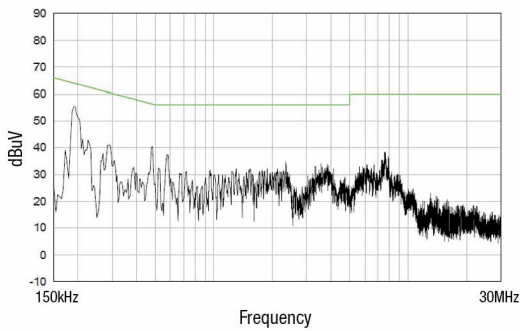

BAC1S12SC (110V) - Neutral

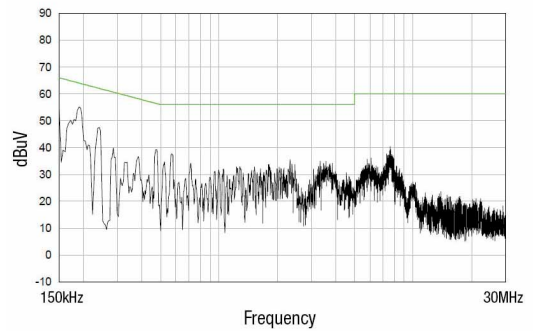

EMC FILTERING AND SPECTRA (Continued)

BAC1S05SC (230V) - Live

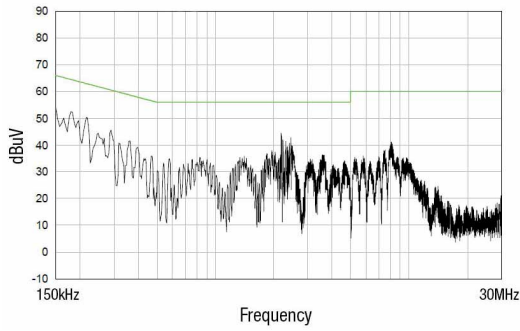

BAC1S05SC (230V) - Neutral

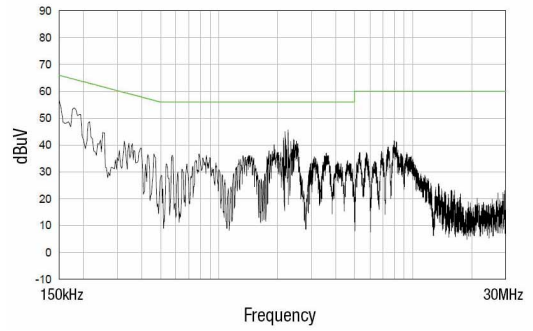

BAC1S12SC (230V) - Live

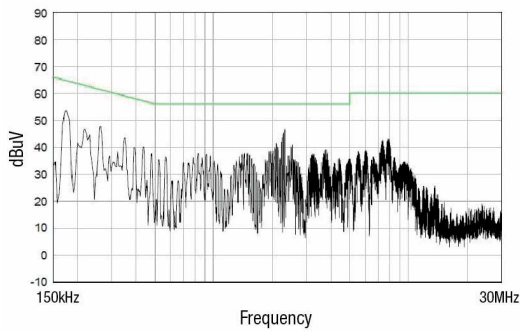

BAC1S12SC (230V) - Neutral

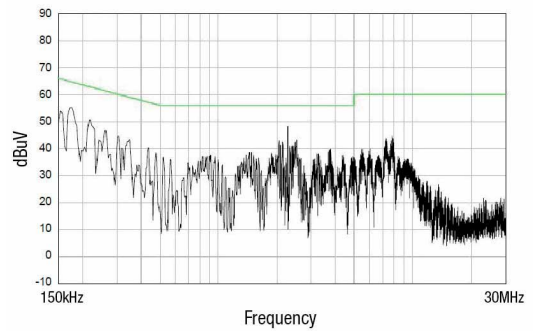

EMC FILTERING AND SPECTRA (Continued)

FILTERING

The following filter circuit and filter table shows the input filters typically required to meet EN55032 Quasi-Peak (green line) Curve B peak conducted emissions.

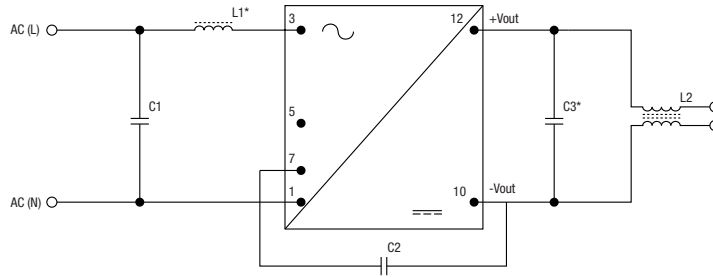

BAC1S24SC	
Component	Description
C1	68nF 305VAC
L1	refer to "components required to match datasheet specifications"
C2	100pF Y-cap
C3	refer to "components required to match datasheet specifications"
L2	DLW21SN261SQ2L

Components marked with an asterisk are already fitted and should not be duplicated

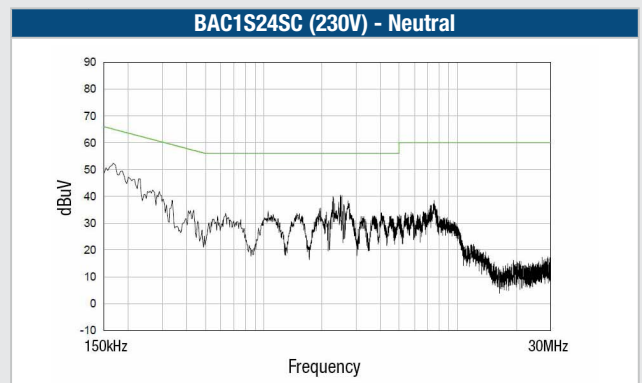
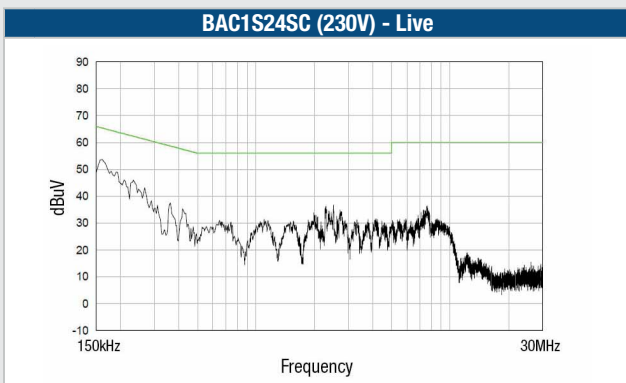
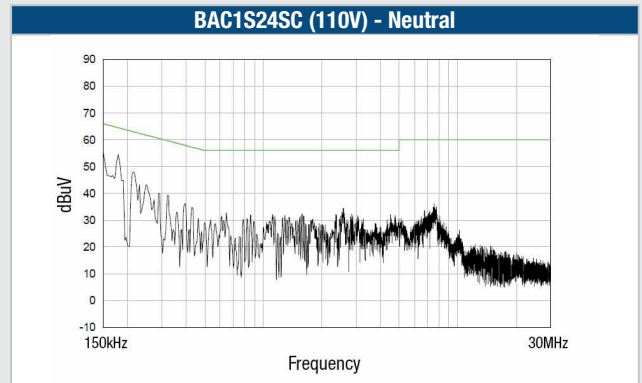
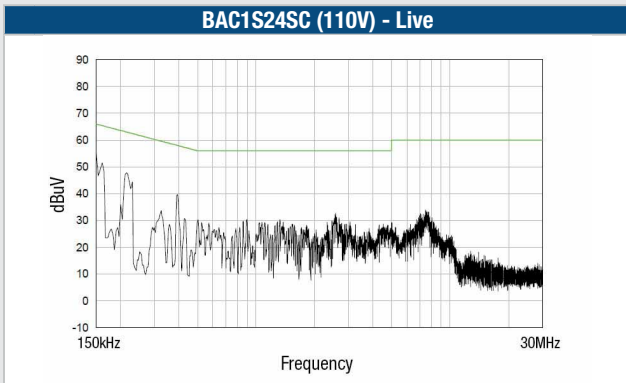

PACKAGE SPECIFICATIONS

MECHANICAL DIMENSIONS

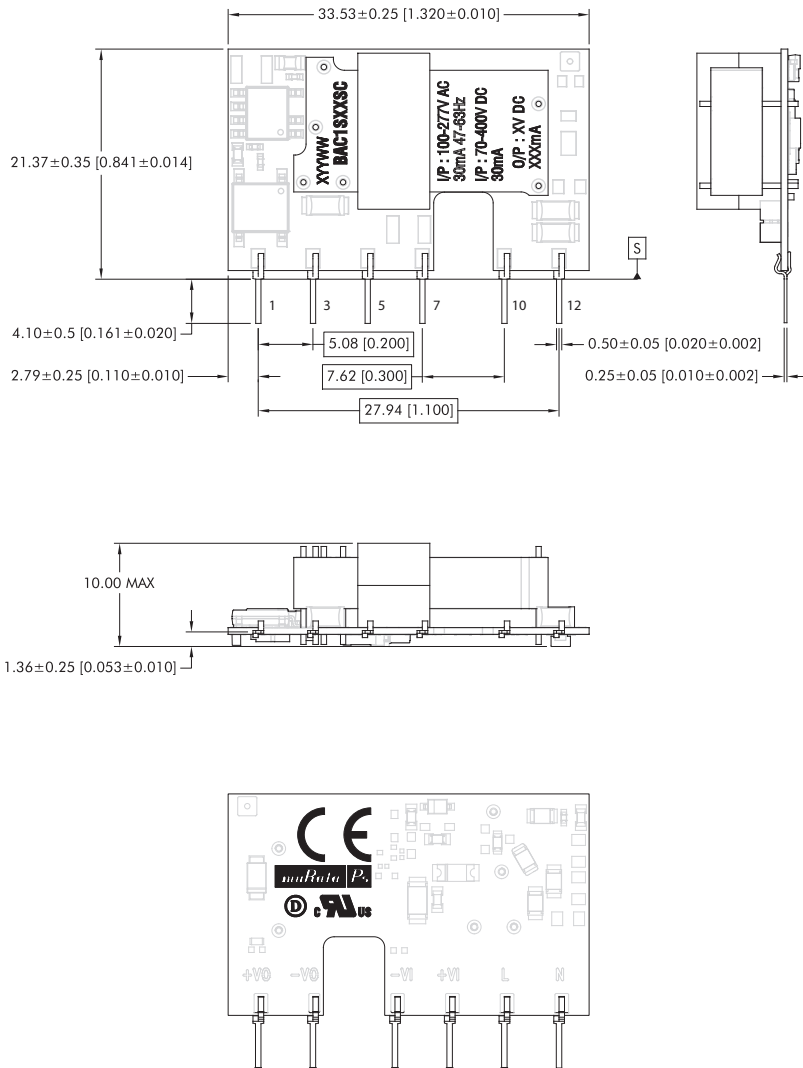

All dimensions in mm (inches) Controlling dimension is mm.
 All pins on a 2.54 (0.100) pitch and within ±0.1 (0.004) of true position from pin 1 at seating plane 'S'

Weight:6.2g

PIN CONNECTIONS

Pin Output

Pin	Function
1	AC (N)
3	AC (L)
5	+Vin (DC)
7	-Vin (DC)
10	-Vout
12	+Vout

RECOMMENDED FOOTPRINT DETAILS

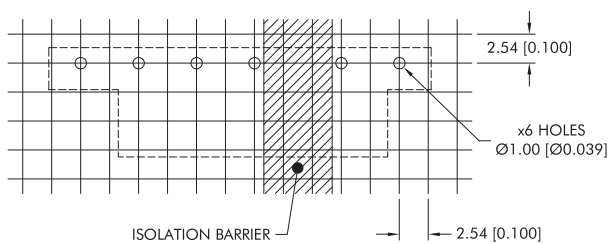

The isolation barrier shown must not have any copper traces even on internal layers. This is to avoid compromising the creepage and clearance distance. PCB layouts must take into consideration the required clearance and creepage requirements to maintain the clearance and creepage of the isolation barrier. All dimensions in mm (inches).

PACKAGING SPECIFICATIONS (Continued)

TRAY OUTLINE DIMENSIONS

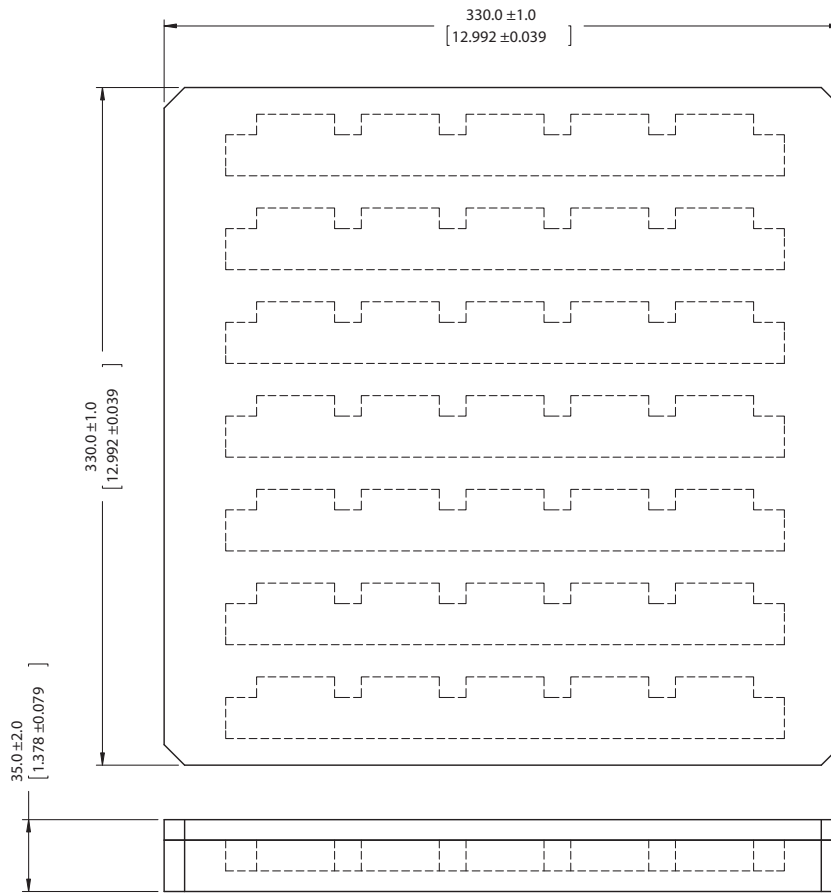

EPE Tray/Lid
Quantity: 35

All dimensions in mm (inches) Controlling dimension is mm.

DISCLAIMER

Unless otherwise stated in the datasheet, all products are designed for standard commercial and industrial applications and NOT for safety-critical and/or life-critical applications.

Particularly for safety-critical and/or life-critical applications, i.e. applications that may directly endanger or cause the loss of life, inflict bodily harm and/or loss or severe damage to equipment/property, and severely harm the environment, a prior explicit written approval from Murata is strictly required. Any use of Murata standard products for any safety-critical, life-critical or any related applications without any prior explicit written approval from Murata shall be deemed unauthorised use.

These applications include but are not limited to:

- Aircraft equipment
- Aerospace equipment
- Undersea equipment
- Power plant control equipment
- Medical equipment
- Transportation equipment (automobiles, trains, ships, etc.)
- Traffic signal equipment
- Disaster prevention / crime prevention equipment
- Data Processing equipment

Murata makes no express or implied warranty, representation, or guarantee of suitability, fitness for any particular use/purpose and/or compatibility with any application or device of the buyer, nor does Murata assume any liability whatsoever arising out of unauthorised use of any Murata product for the application of the buyer. The suitability, fitness for any particular use/purpose and/or compatibility of Murata product with any application or device of the buyer remain to be the responsibility and liability of the buyer.

Buyer represents and agrees that it has all the necessary expertise to create and implement safeguards that anticipate dangerous consequences of failures, monitor failures and their consequences, lessen the likelihood of failures that might cause harm, and take appropriate remedial actions. Buyer will fully indemnify and hold Murata, its affiliated companies, and its representatives harmless against any damages arising out of unauthorised use of any Murata products in any safety-critical and/or life-critical applications.

Remark: Murata in this section refers to Murata Manufacturing Company and its affiliated companies worldwide including, but not limited to, Murata Power Solutions.



This product is subject to the following [operating requirements](#) and the [Life and Safety Critical Application Sales Policy](#):

Refer to: <http://www.murata-ps.com/requirements/>

Murata Power Solutions (Milton Keynes) Ltd. makes no representation that the use of its products in the circuits described herein, or the use of other technical information contained herein, will not infringe upon existing or future patent rights. The descriptions contained herein do not imply the granting of licenses to make, use, or sell equipment constructed in accordance therewith. Specifications are subject to change without notice.

© 2021 Murata Power Solutions (Milton Keynes) Ltd.