

173950x78

MagI³C Power Module

FDSM – Fixed Step Down Regulator Module



**WÜRTH
ELEKTRONIK**
MORE THAN
YOU EXPECT

6V – 28V / 500mA / 3.3V or 5V Output

DESCRIPTION

The FDSM series of the MagI³C Power Module family is a fixed output voltage, fully integrated DC-DC power supply including the switching regulator, inductor and capacitors all in one package.

The module requires no external components for operation, reducing design effort and complexity to a minimum.

The FDSM ensures fast time to market and low development costs.

It is pin compatible with the common 78xx linear regulator series. The high efficiency reduces the power dissipation and in many cases a heatsink and assembly parts are unnecessary.

12V to 3.3V conversion achieves up to 85% efficiency.
12V to 5V conversion achieves up to 90% efficiency.

The standard THT (10.5 x 11.6 X 8.5mm) package allows for easy assembly.

FEATURES

- Peak efficiency up to 95%
- Current capability up to 500mA
- Input voltage range: 6V to 28V
- Output voltage: 3.3V or 5V
- No minimum load required
- Integrated input and output capacitors
- Integrated inductor
- Low output voltage ripple (typ 10mV_{pp})
- Fixed 570kHz switching frequency
- Current mode control
- Pulse skipping for high efficiency at light loads
- Internal soft-start
- Thermal shutdown
- Short circuit protection
- Cycle by cycle current limit
- Pin compatible with the FDSM power modules series
- Operating ambient temperature range: -40°C to 85°C
- RoHS & REACH compliant
- Case and potting material UL 94 Class V0 (flammability testing) certified
- Complies with EN55032 class B conducted and radiated emissions standard

TYPICAL APPLICATIONS

- Point-of-Load DC-DC applications from 9V, 12V, 15V, 18V and 24V industrial rails
- Replacement for linear regulator
- Interface and microcontroller supply
- General purpose

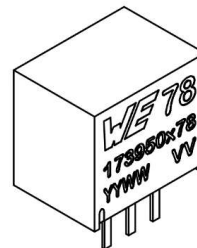

TYPICAL CIRCUIT DIAGRAM

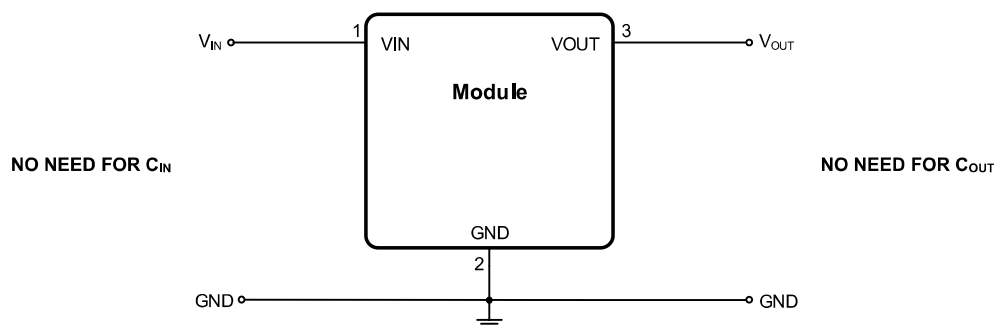

173950x78

MagI³C Power Module

FDSM – Fixed Step Down Regulator Module



WÜRTH
ELEKTRONIK
MORE THAN
YOU EXPECT

PINOUT (PACKAGE TYPE F)

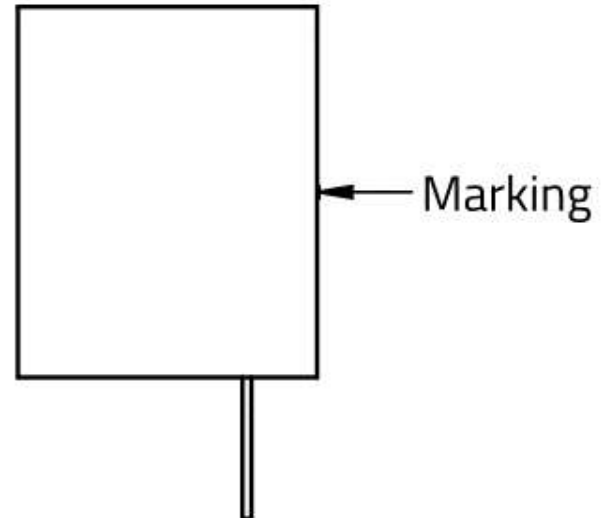
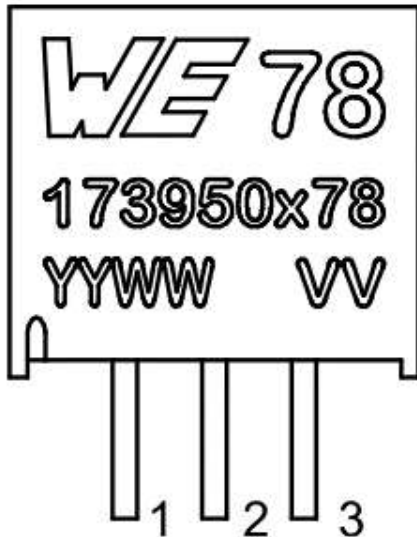

Type F package (pins are located at the front)

MARKING DESCRIPTION

MARKING	DESCRIPTION
WE	Würth Elektronik eiSos GmbH & Co. KG
78	Indicates the compatibility with 78xx linear regulator
173950X78	Order code
YY	Year
WW	Calendar week
VV	Output voltage

PIN DESCRIPTION

SYMBOL	PIN	TYPE	DESCRIPTION
VIN	1	Power	The supply input pin is a terminal for an unregulated input voltage source. There is no need for an external input capacitor.
GND	2	Power	Ground reference for VIN and VOUT
VOUT	3	Power	Regulated output voltage. There is no need for an external output capacitor.

173950x78**MagI³C** Power Module**FDSM** – Fixed Step Down Regulator Module
**WÜRTH
ELEKTRONIK**
 MORE THAN
 YOU EXPECT
ORDERING INFORMATION

ORDER CODE	SPECIFICATIONS	PACKAGE	PACKAGING UNIT
173950378	28V / 500mA / 3.3Vout	Type F	Tube with 42 pieces
173950578	28V / 500mA / 5Vout		

PIN COMPATIBLE FAMILY MEMBERS

ORDER CODE	SPECIFICATIONS	PACKAGE	PACKAGING UNIT
173010378	28V / 1A / 3.3Vout	Type F	Tube with 42 pieces
173010578	28V / 1A / 5Vout		
173010342	42V / 1A / 3.3Vout		Tube with 43 pieces
173010542	42V / 1A / 5Vout		
173950336	36V / 500mA / 3.3Vout		
173950536	36V / 500mA / 5Vout		
173951236	36V / 500mA / 12Vout		
173951536	36V / 500mA / 15Vout		
173010335	36V / 1A / 3.3Vout		
173010535	36V / 1A / 5Vout		
173011235	36V / 1A / 12Vout		
173011535	36V / 1A / 15Vout		
173950375	74.5V / 500mA / 3.3Vout	Type B	Tube with 43 pieces
173950575	74.5V / 500mA / 5Vout		
173951275	74.5V / 500mA / 12Vout		

SALES INFORMATION

SALES CONTACTS
Würth Elektronik eiSos GmbH & Co. KG EMC & Inductive Solutions Max-Eyth-Str. 1 74638 Waldenburg Germany Tel. +49 (0) 7942 945 0 www.we-online.com/powermodules Technical support: powermodules@we-online.com

173950x78**MagI³C** Power Module**FDSM** – Fixed Step Down Regulator Module**WÜRTH
ELEKTRONIK**
MORE THAN
YOU EXPECT**ABSOLUTE MAXIMUM RATINGS**

Caution:

Exceeding the listed absolute maximum ratings may affect the device negatively and may cause permanent damage. These are stress ratings only, which do not imply functional operation of the device at these or any other condition beyond those indicated under "Operation Conditions".

SYMBOL	PARAMETER	LIMITS		UNIT
		MIN ⁽¹⁾	MAX ⁽¹⁾	
V _{IN}	Input pin voltage	-0.3	30	V
V _{OUT}	Output pin voltage	-0.6	30	V
T _{storage}	Assembled, non-operating storage temperature	-55	125	°C
V _{ESD}	ESD Voltage (Human Body Model), according to EN61000-4-2 ⁽²⁾	-	±2000	V

OPERATING CONDITIONS

Operating conditions are conditions under which operation of the device is intended to be functional. All values are referenced to GND.

MIN and MAX limits are valid for the recommended ambient temperature range of **-40°C to 85°C**. Typical values represent statistically the utmost probable values at the following conditions: V_{IN} = 6V to 28V (173950378), V_{IN} = 7V to 28V (173950578), I_{OUT} = 500mA⁽⁵⁾, T_A = 25°C, unless otherwise specified.

SYMBOL	PARAMETER	MIN ⁽¹⁾	TYP ⁽³⁾	MAX ⁽¹⁾	UNIT
V _{IN}	Input voltage (173950378)	6	-	28	V
V _{IN}	Input voltage (173950578)	7	-	28	V
T _A	Ambient temperature range	-40	-	+85 ⁽⁴⁾	°C
I _{OUT}	Nominal output current	-	-	500	mA
C _{OUT MAX}	Maximum output capacitor			220	µF

THERMAL SPECIFICATIONS

SYMBOL	PARAMETER	TYP ⁽³⁾	UNIT
θ _{CA}	Case-to-ambient thermal resistance ⁽⁵⁾	70	K/W
T _{case max}	Maximum case temperature ⁽⁵⁾	100	°C
T _{SD}	Thermal shutdown, junction temperature rising	165	°C

ELECTRICAL SPECIFICATIONS

MIN and MAX limits are valid for the recommended ambient temperature range of **-40°C to 85°C**. Typical values represent statistically the utmost probability at the following conditions: $V_{IN} = 6V$ to $28V$ (173950378), $V_{IN} = 7V$ to $28V$ (173950578), $I_{OUT} = 500mA^{(5)}$, $T_A = 25°C$, unless otherwise specified.

SYMBOL	PARAMETER	TEST CONDITIONS	MIN ⁽¹⁾	TYP ⁽³⁾	MAX ⁽¹⁾	UNIT
Output current						
I_{CL}	Current limit threshold	$V_{IN} = 12V$	2.3	3.5	5.3	A
Output voltage						
V_{OUT}	Regulated output voltage	173950378	3.201	3.3	3.399	V
	Regulated output voltage	173950578	4.850	5	5.150	V
	Line regulation	$I_{OUT} = 5mA$ to $500mA$	-	-	± 0.5	%
	Load regulation	10% to 100% Load	-	-	± 1	%
	Total output voltage variation	$T_A = 25°C$, $I_{OUT} = 500mA$	-	-	± 3	%
	Output voltage ripple	$V_{OUT} = 3.3V$, $I_{OUT} = 500mA$ $C_{OUT} = 10\mu F$ X5R, 20MHz BWL	-	10	-	mV _{pp}
	$V_{OUT} = 5V$, $I_{OUT} = 500mA$ $C_{OUT} = 10\mu F$ X5R, 20MHz BWL	-	10	-	mV _{pp}	
Switching frequency						
f_{SW}	Switching frequency	$V_{IN} = 12V$, Continuous Conduction Mode (CCM)	400	570	740	kHz
Input current						
I_{IN}	No load input current	Operating, switching	-	1.5	-	mA
Efficiency						
η	Efficiency	$V_{IN} = 6V$, $V_{OUT} = 3.3V$	-	91	-	%
		$V_{IN} = 28V$, $V_{OUT} = 3.3V$	-	77	-	%
		$V_{IN} = 7V$, $V_{OUT} = 5V$	-	95	-	%
		$V_{IN} = 28V$, $V_{OUT} = 5V$	-	83	-	%

173950x78

MagI³C Power Module

FDSM – Fixed Step Down Regulator Module



WÜRTH
ELEKTRONIK
MORE THAN
YOU EXPECT

RELIABILITY

SYMBOL	PARAMETER	TEST CONDITIONS	TYP ⁽³⁾	UNIT
MTBF ⁽⁶⁾	Mean Time Between Failures	MIL-HDBK-217F, +25°C	4185 · 10 ³	h
MTBF ⁽⁶⁾	Mean Time Between Failures	MIL-HDBT-217F, +70°C	2182 · 10 ³	h

RoHS, REACH

RoHS Directive		Directive 2011/65/EU of the European Parliament and the Council of June 8th, 2011 on the restriction of the use of certain hazardous substances in electrical and electronic equipment.
REACH Directive		Directive 1907/2006/EU of the European Parliament and the Council of June 1st, 2007 regarding the Registration, Evaluation, Authorisation and Restriction of Chemicals (REACH)

PACKAGE SPECIFICATIONS

ITEM	PARAMETER	TYP ⁽³⁾	UNIT
Case	Non-conductive black plastic, UL94V-0	-	-
Potting material	Silicone, UL94V-0	-	-
Weight	-	2	g

NOTES

- (1) Min and Max limits are 100% production tested at 25°C. Limits over the operating temperature range are guaranteed through correlation using Statistical Quality Control (SQC) methods.
- (2) The human body model is a 100pF capacitor discharged through a 1.5 kΩ resistor into each pin. Test method is per JESD-22-114.
- (3) Typical numbers are valid at 25°C ambient temperature and represent statistically the utmost probability assuming the Gaussian distribution.
- (4) Depending on load current, see derating diagram.
- (5) Measured without heatsink, no airflow.
- (6) MIL-HDBK-217F; GB Ground, Benign: Non mobile, temperature and humidity controlled environments readily accessible to maintenance; includes laboratory instruments and test equipment, medical electronic equipment, business and scientific computer complexes, and missiles and support equipment in ground silos.

TYPICAL PERFORMANCE CURVES

If not otherwise specified, the following conditions apply: $V_{IN} = 24V$; $V_{OUT} = 3.3V$ (173950378) & $5V$ (173950578); $I_{OUT} = 500mA$; $T_{AMB} = 25^{\circ}C$.

RADIATED AND CONDUCTED EMISSIONS (WITH EMI INPUT FILTER)

The 173950378 & 173950578 power modules are tested with two EMC configurations (long and short wires between the module and the load) to give more realistic information about implementation in the applications. The test setup is based on CISPR16 with the limit values CISPR32.

FILTER SETUP

Input wire length:

- Radiated Emission: 160cm (80cm Horizontal + 80cm Vertical)
- Conducted Emission: 80cm

Output wire length (Radiated & Conducted):

- Short wire: less than 15cm
- Long wire: 1m

SHORT WIRE (15cm): 3.3V_{OUT}

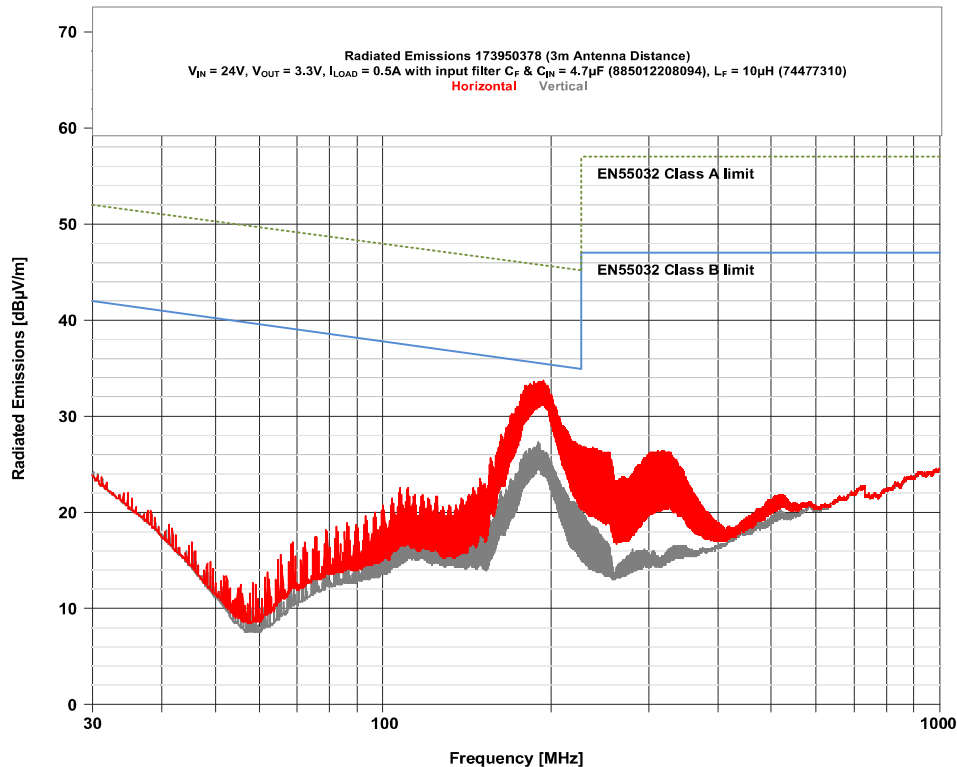

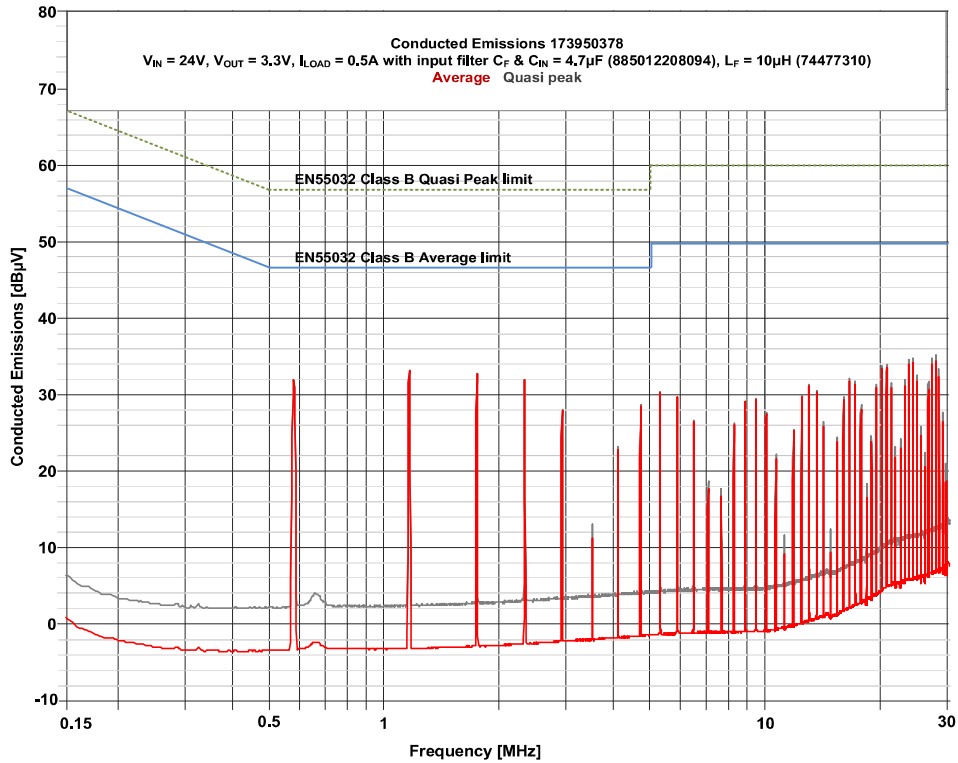

LONG WIRE (1m): 3.3V_{OUT}

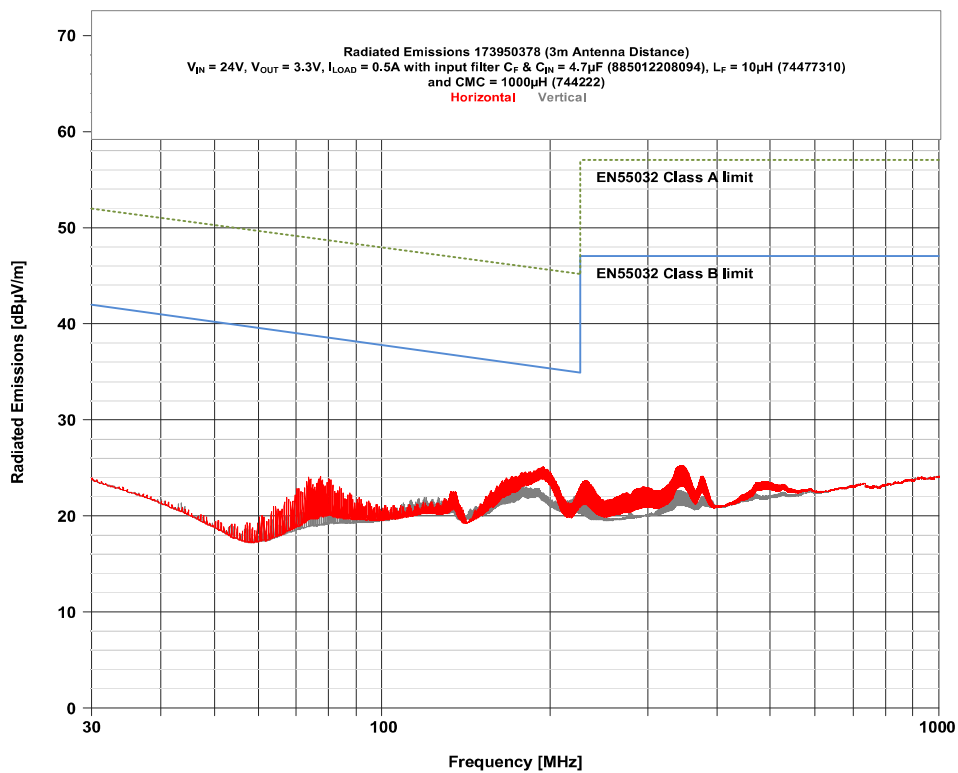

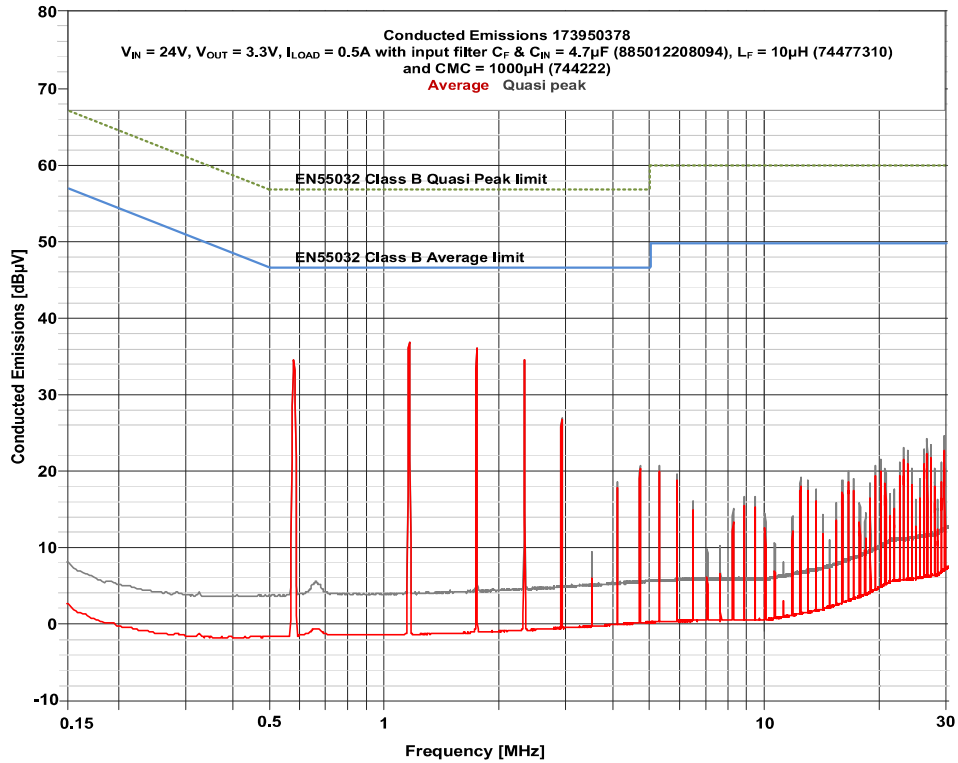

SHORT WIRE (15cm): 5V_{OUT}

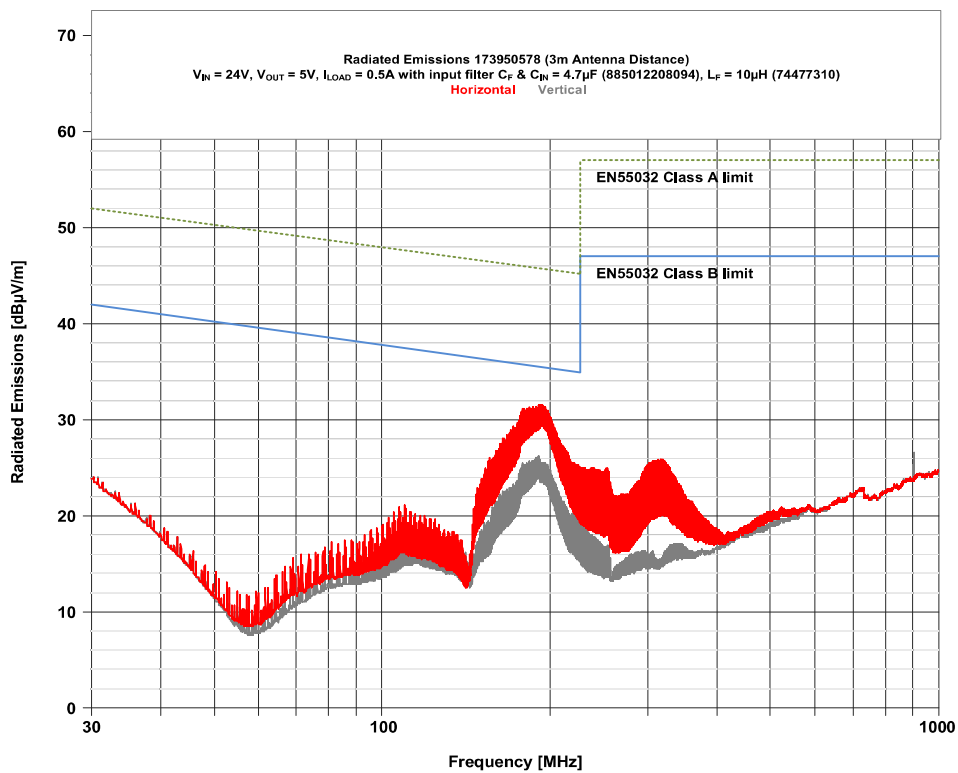

173950x78

MagI³C Power Module

FDSM – Fixed Step Down Regulator Module



WÜRTH
ELEKTRONIK
MORE THAN
YOU EXPECT

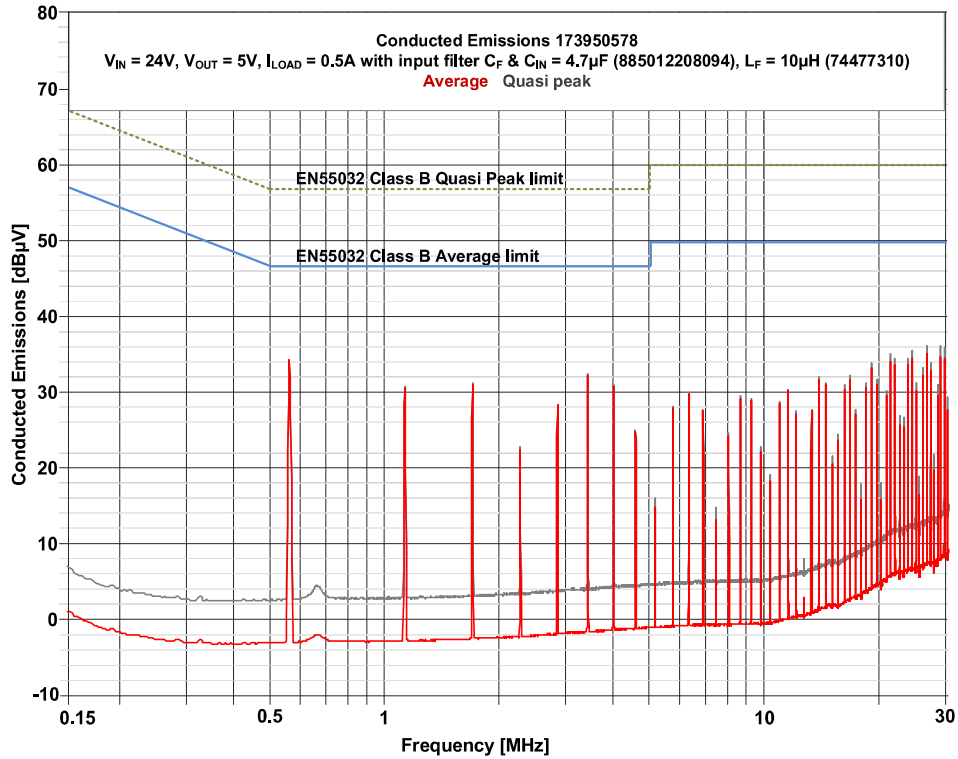

LONG WIRE (1m): 5V_{OUT}

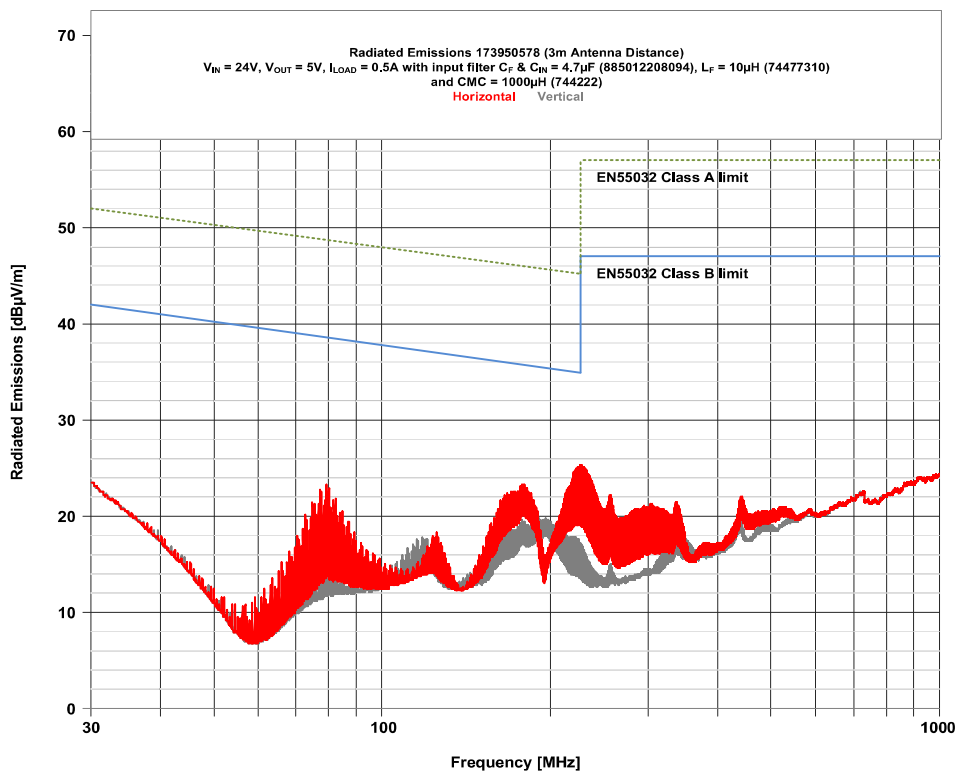

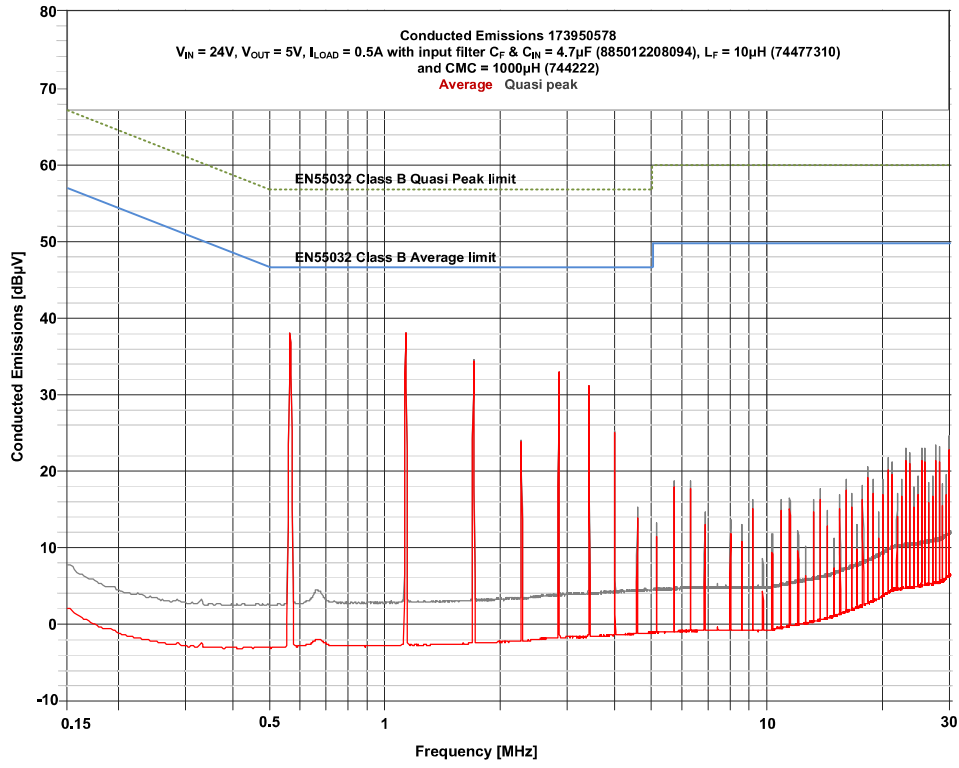



EFFICIENCY

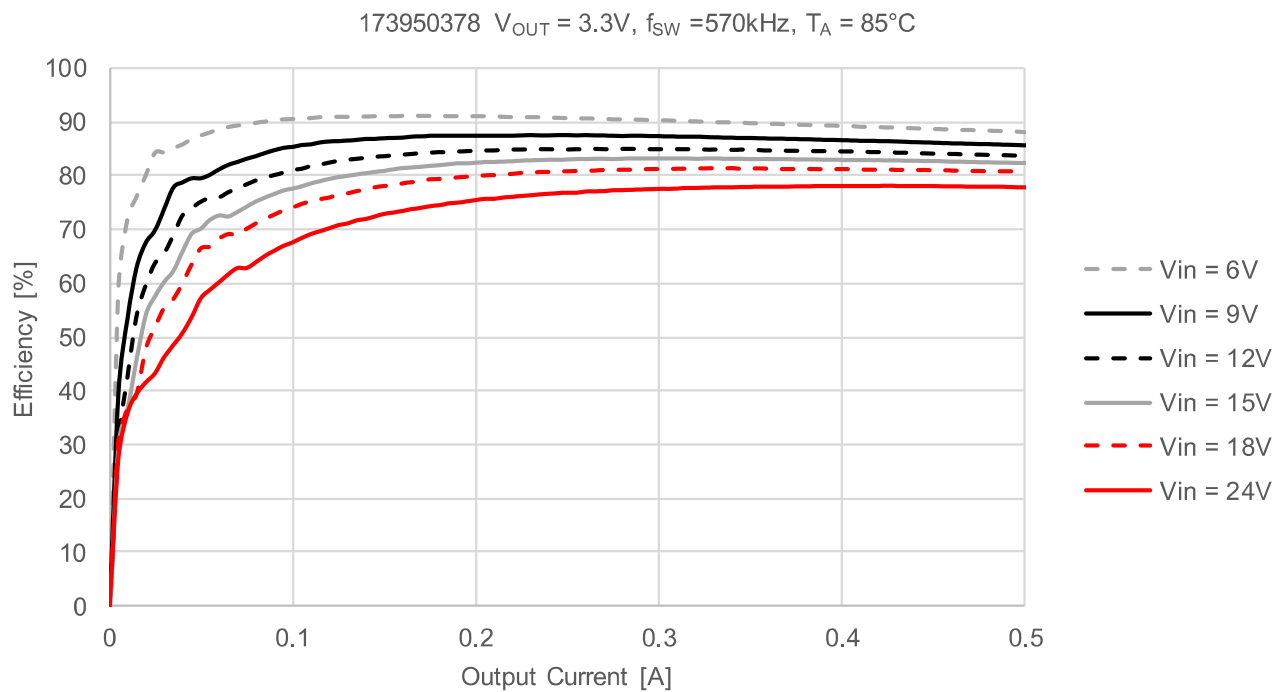
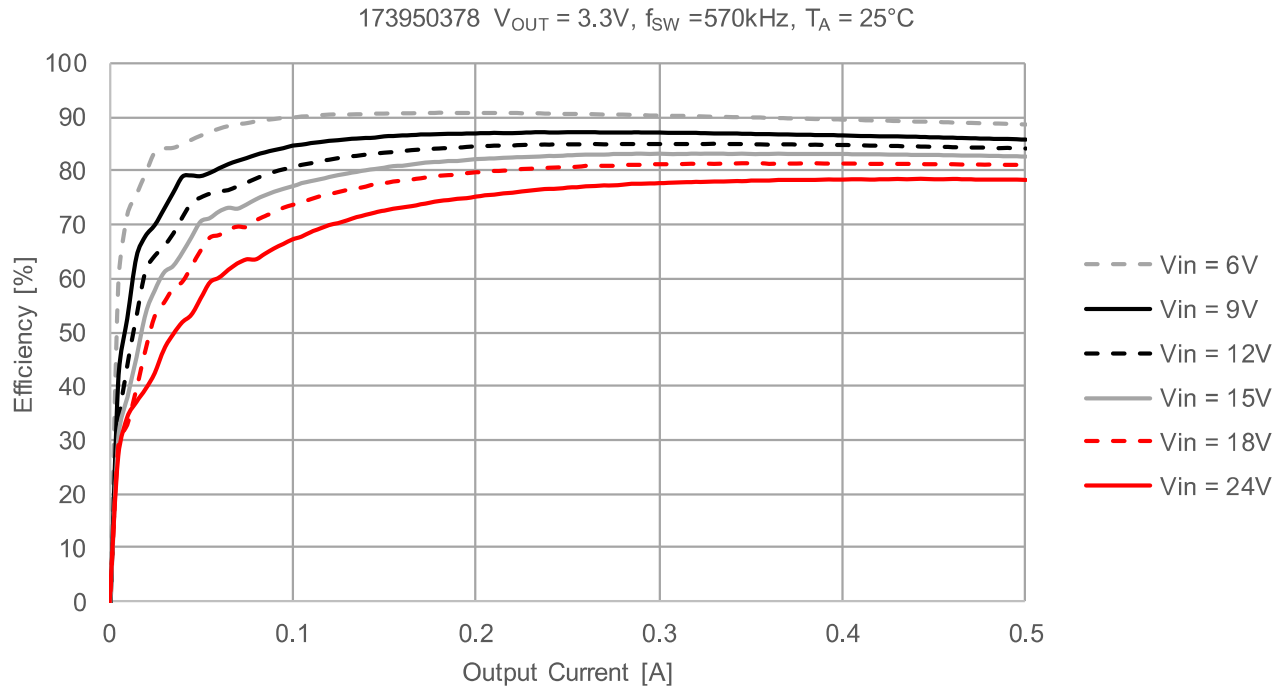



EFFICIENCY

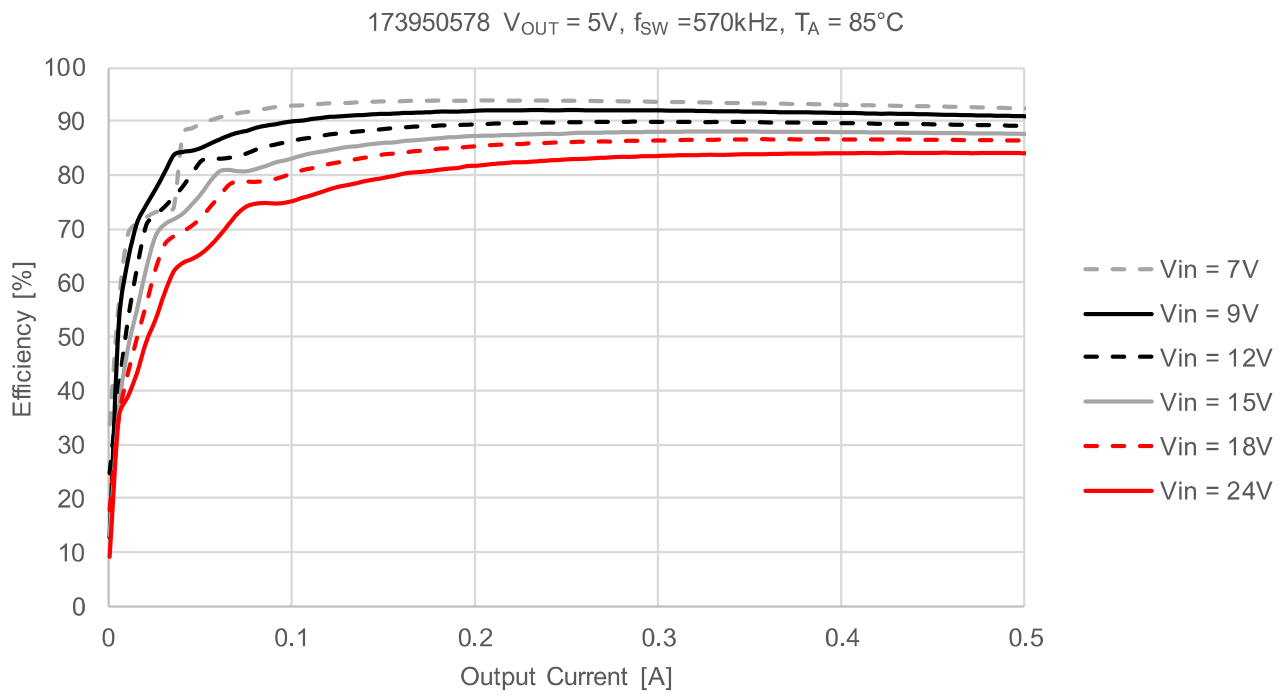
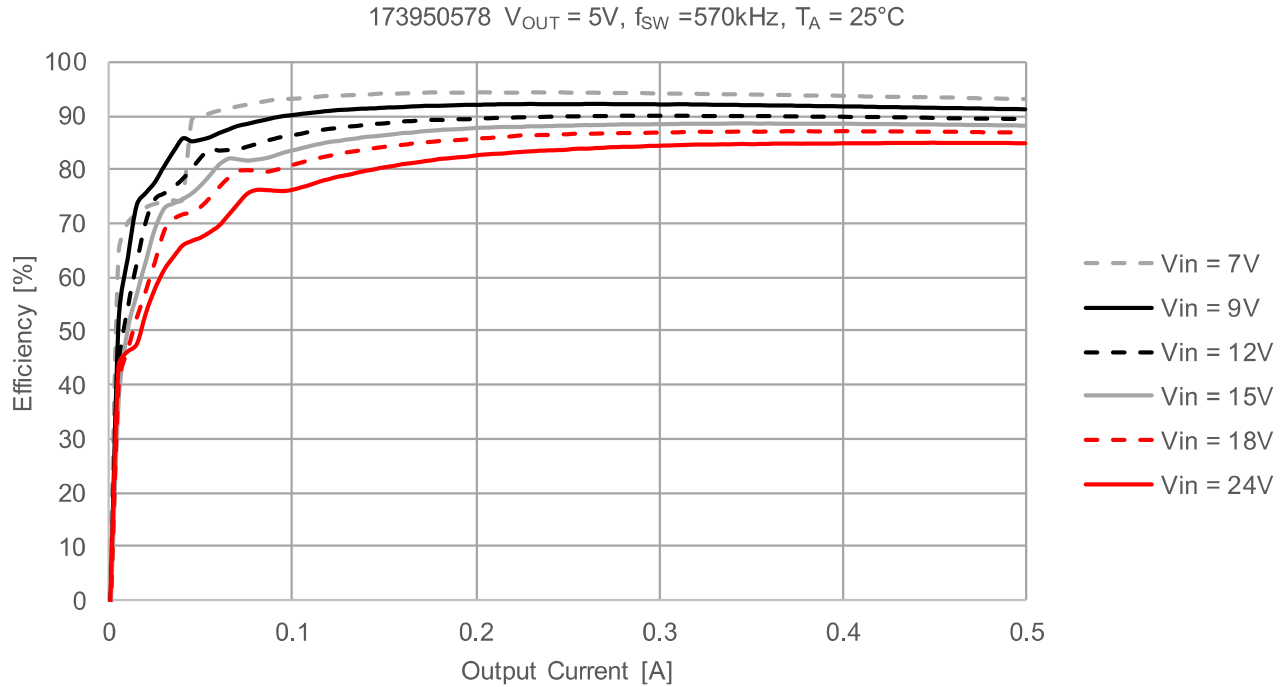



POWER DISSIPATION

173950378 $V_{OUT} = 3.3V$, $f_{SW} = 570kHz$, $T_A = 25^\circ C$

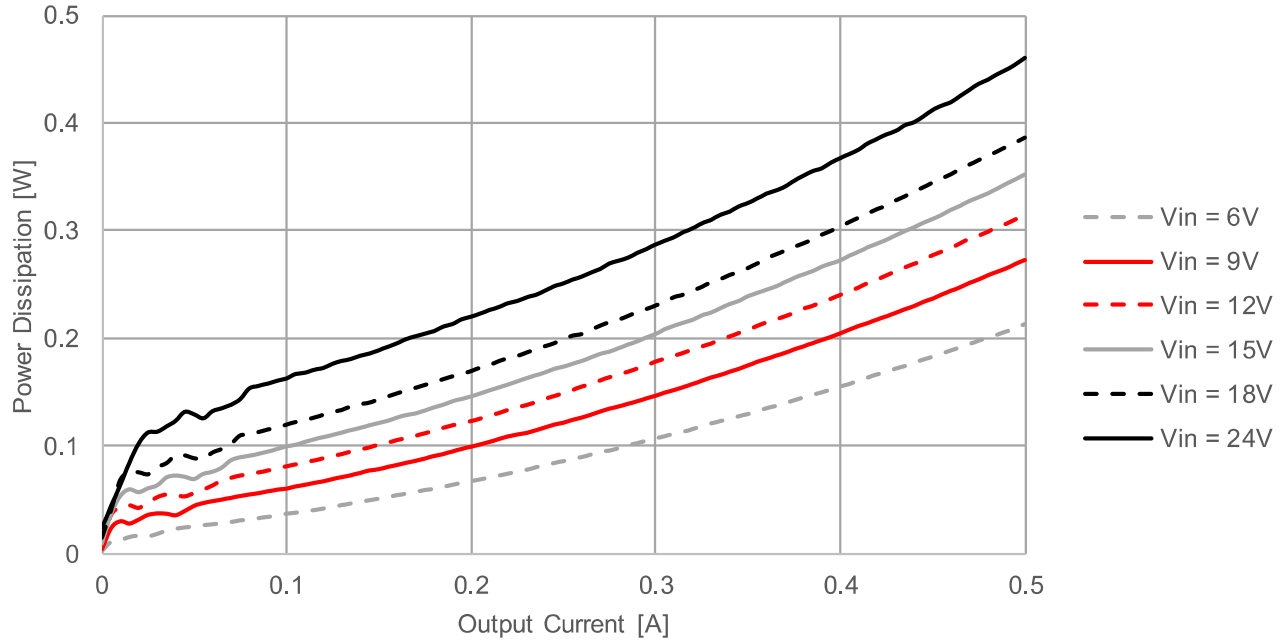

173950378 $V_{OUT} = 3.3V$, $f_{SW} = 570kHz$, $T_A = 85^\circ C$

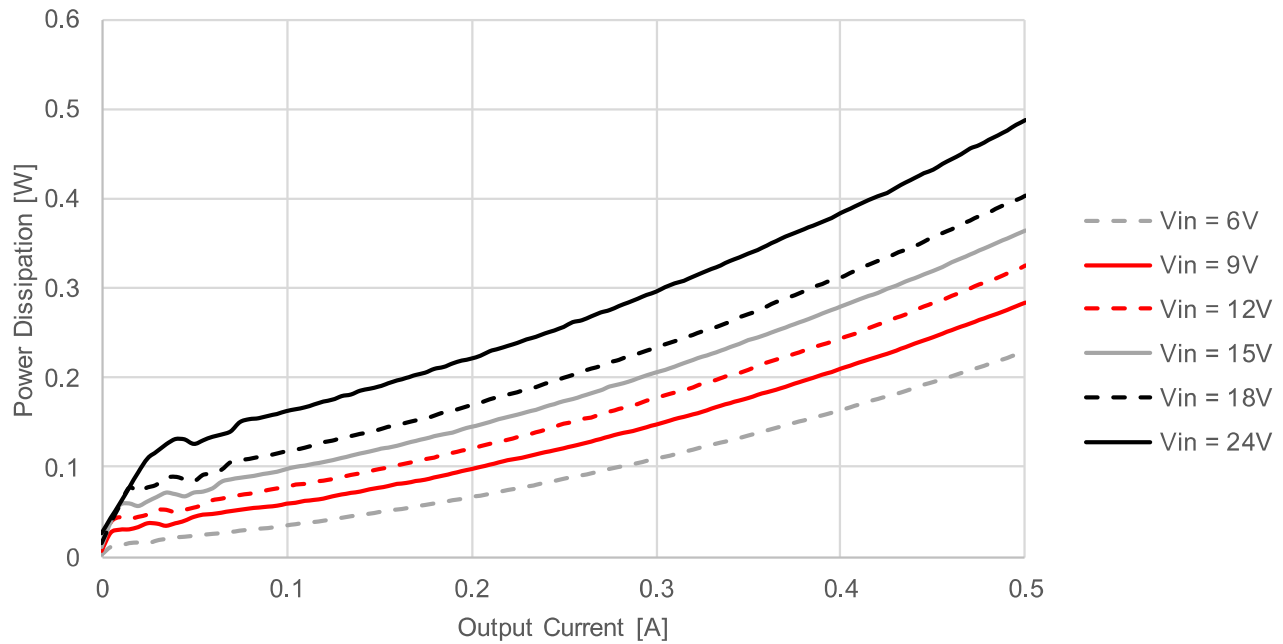



POWER DISSIPATION

173950578 $V_{OUT} = 5V$, $f_{SW} = 570kHz$, $T_A = 25^\circ C$

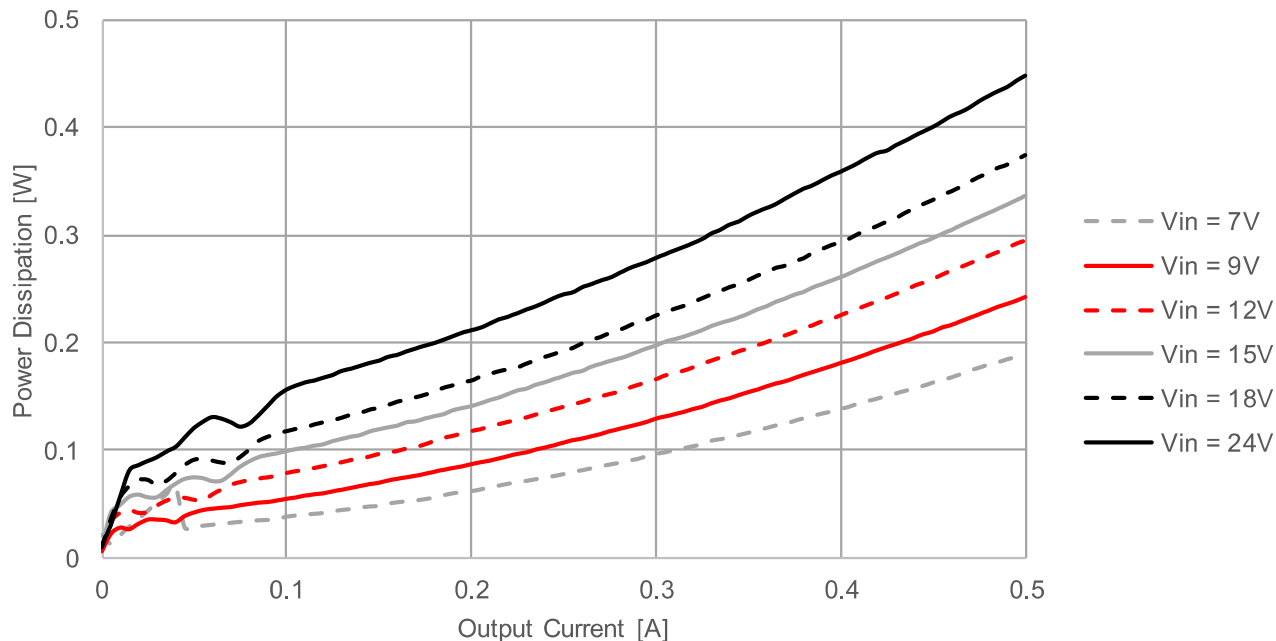

173950578 $V_{OUT} = 5V$, $f_{SW} = 570kHz$, $T_A = 85^\circ C$

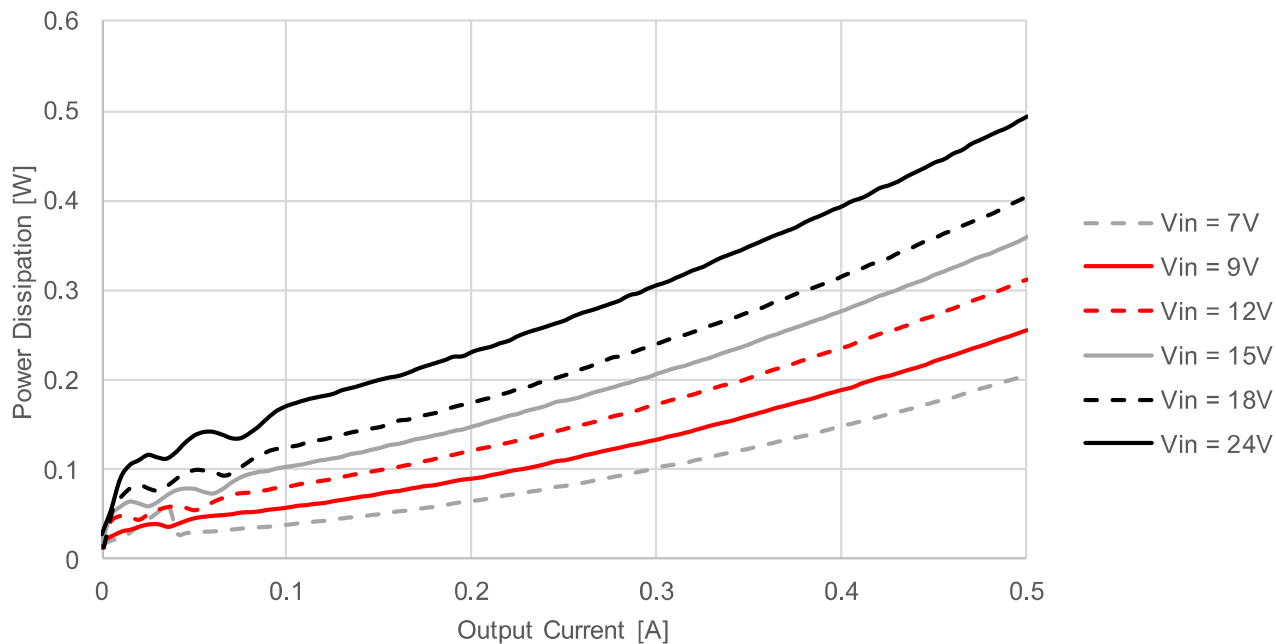



OUTPUT POWER DERATING

173950x78 Output Power Thermal Derating
 $V_{IN} = 24V$, $I_{OUT} = 500mA$ & $f_{SW} = 570kHz$

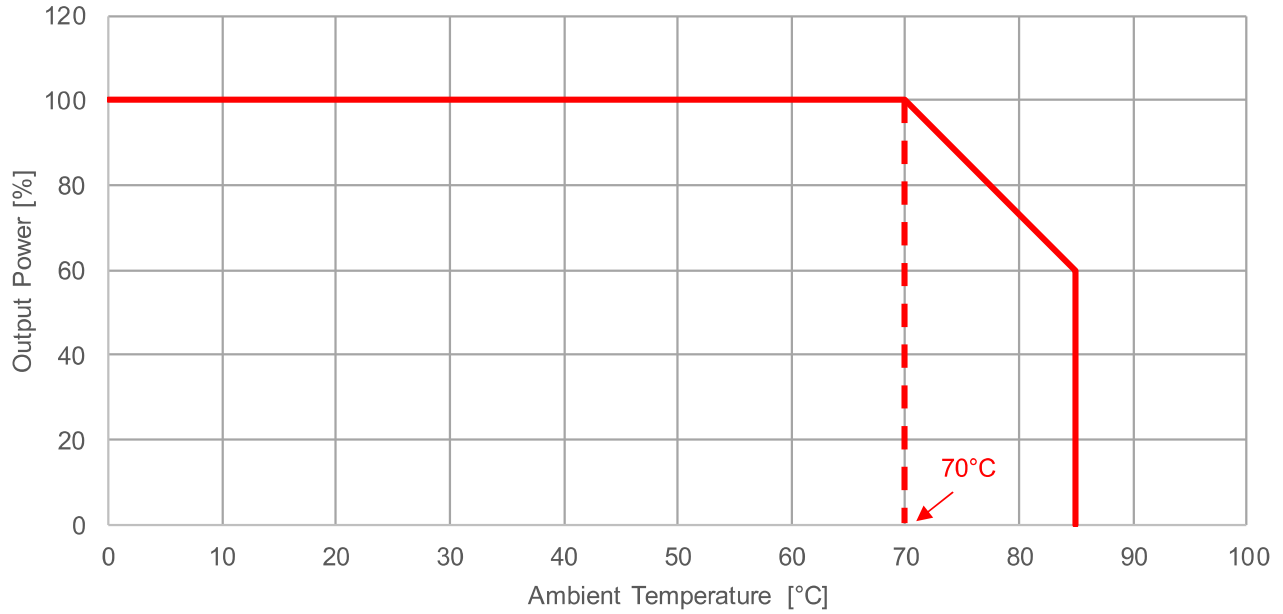

173950x78

MagI³C Power Module

FDSM – Fixed Step Down Regulator Module



WÜRTH
ELEKTRONIK
MORE THAN
YOU EXPECT

LINE REGULATION

173950378 Line Regulation $V_{OUT} = 3.3V$, $T_A = 25^\circ C$

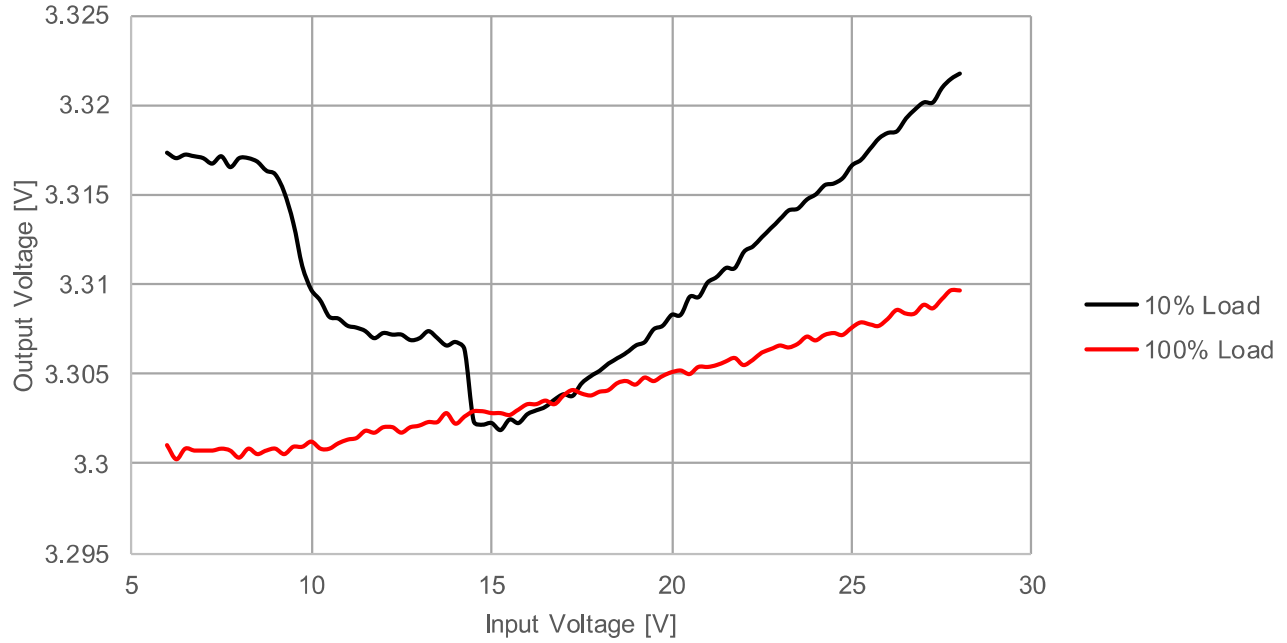

173950578 Line Regulation $V_{OUT} = 5V$, $T_A = 25^\circ C$

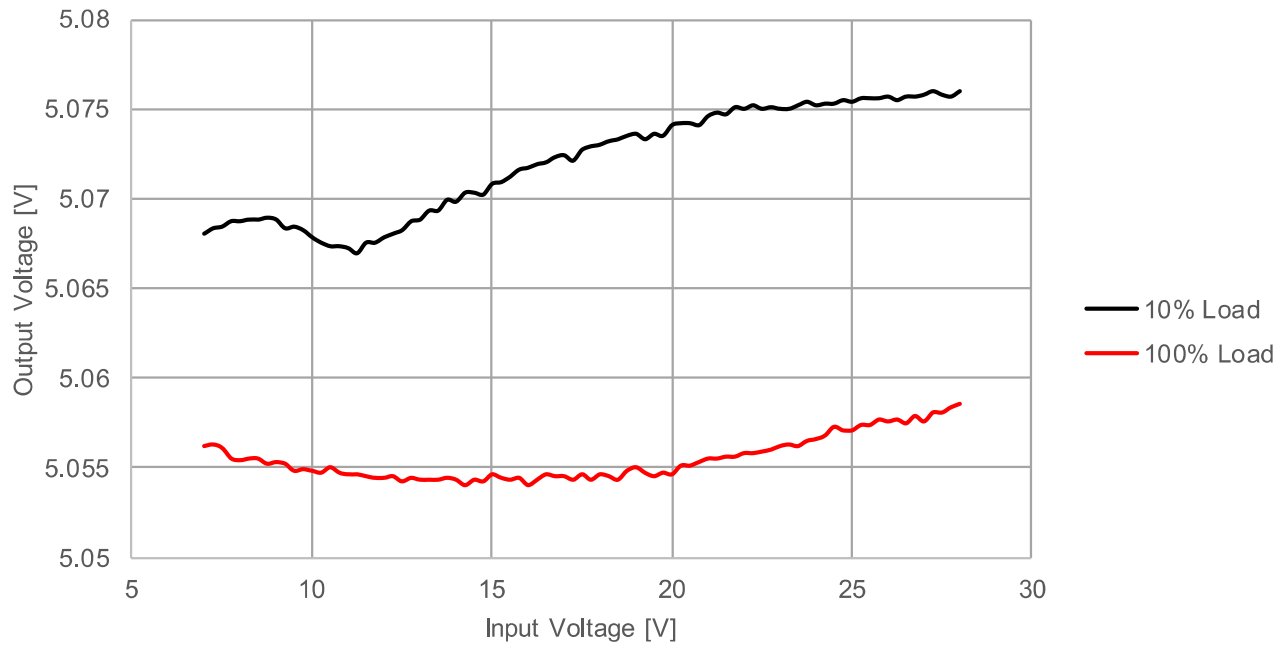

173950x78

MagI³C Power Module

FDSM – Fixed Step Down Regulator Module



WÜRTH
ELEKTRONIK
MORE THAN
YOU EXPECT

LINE REGULATION

173950378 Line Regulation $V_{OUT} = 3.3V$, $T_A = 85^\circ C$

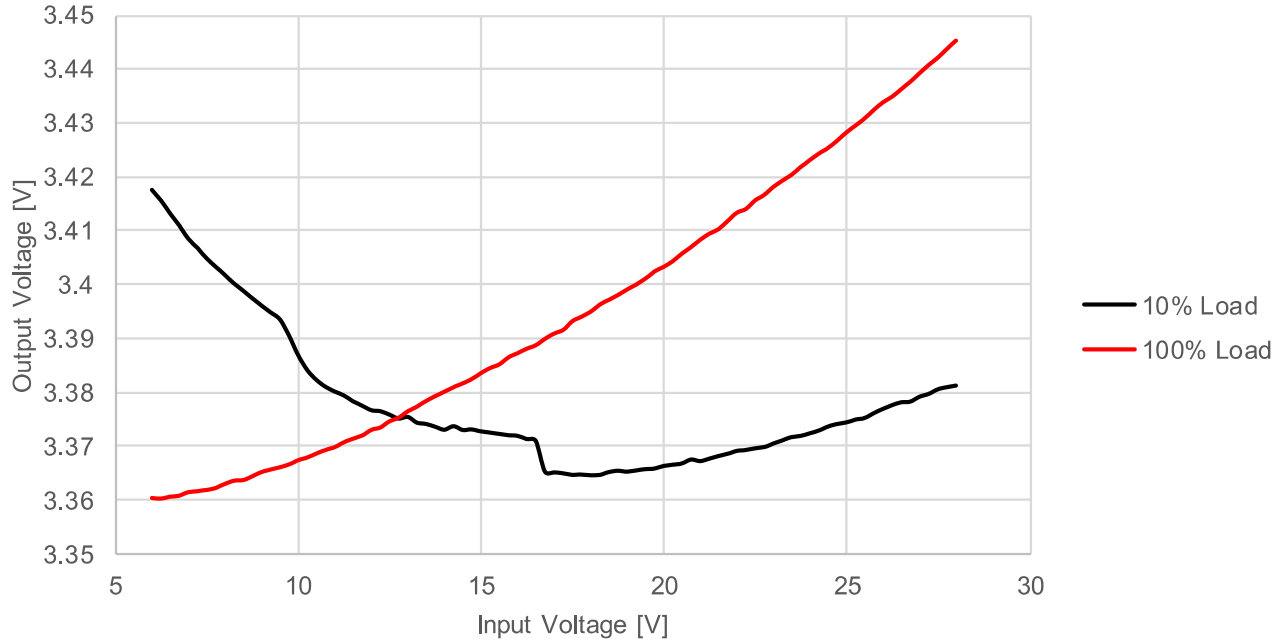

173950578 Line Regulation $V_{OUT} = 5V$, $T_A = 85^\circ C$

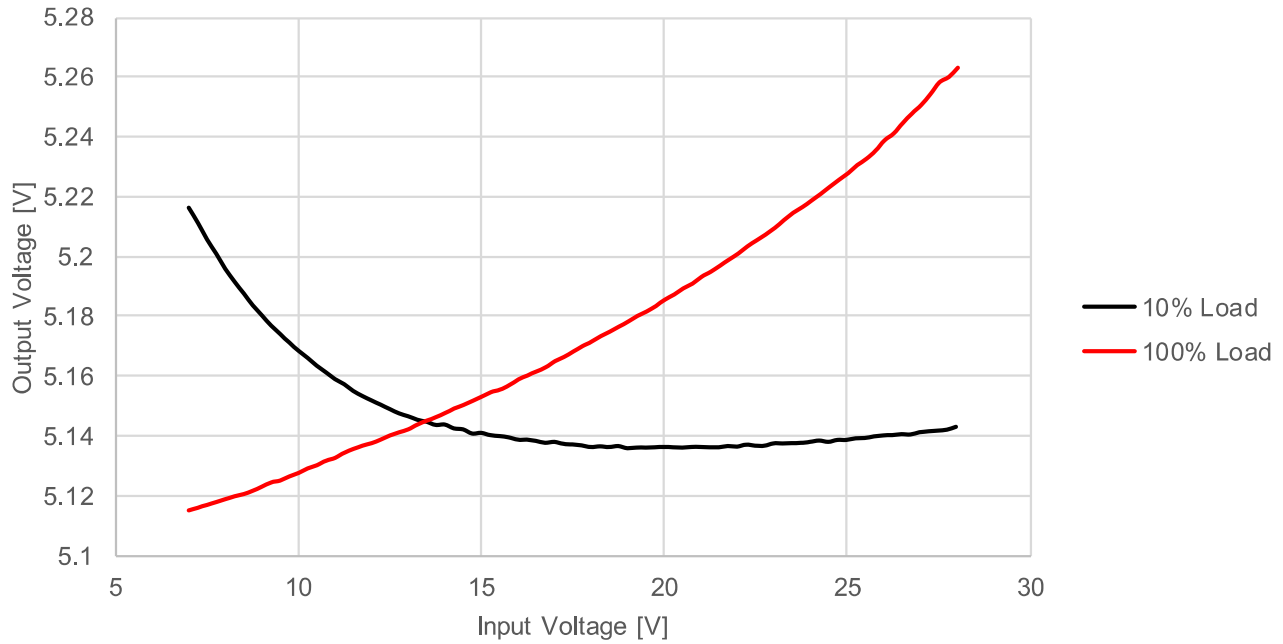



LOAD REGULATION

173950378 Load Regulation $V_{OUT} = 3.3V$, $T_A = 25^\circ C$

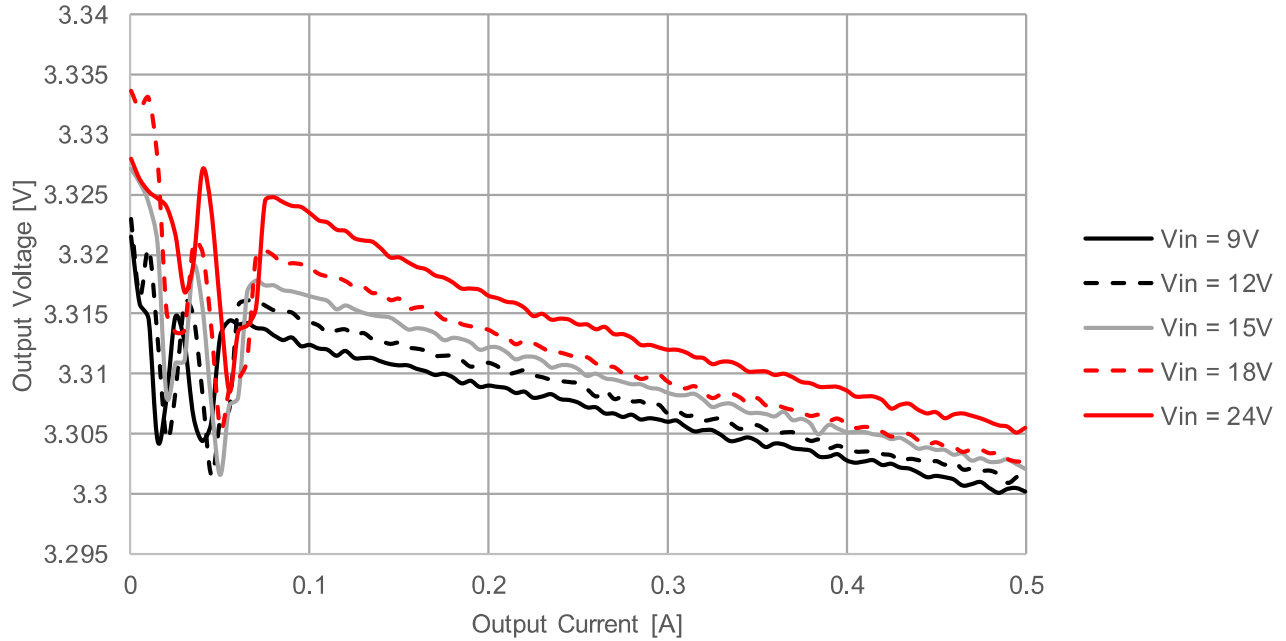

173950378 Load Regulation $V_{OUT} = 3.3V$, $T_A = 85^\circ C$

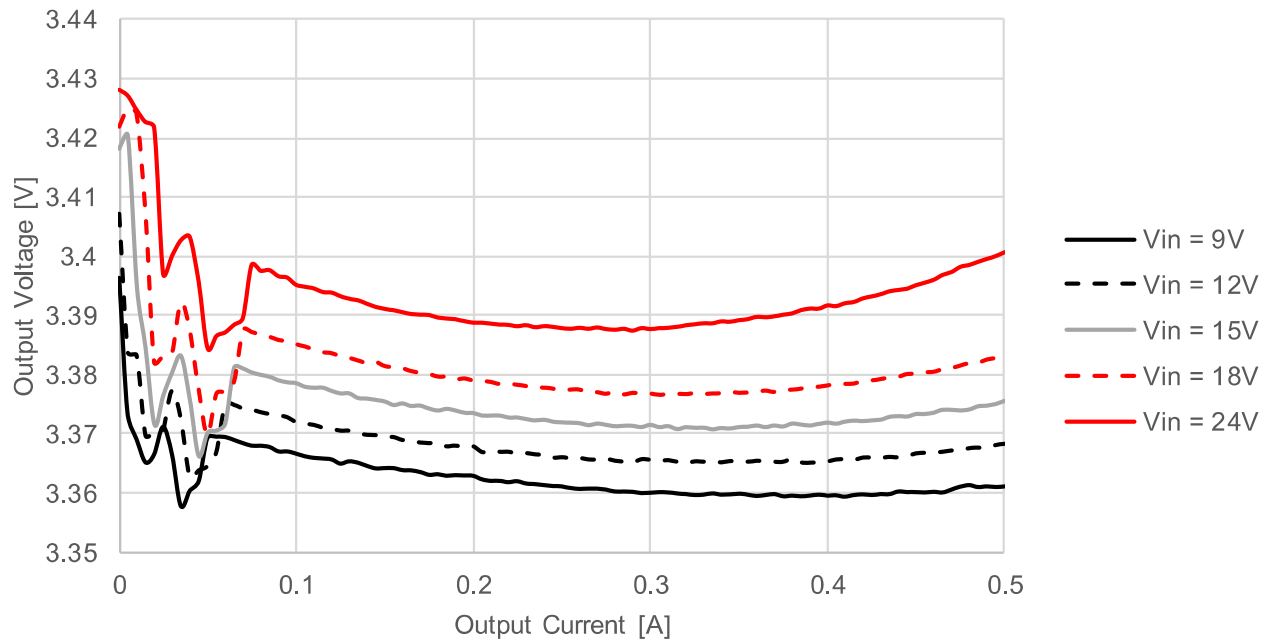



LOAD REGULATION

173950578 Load Regulation $V_{OUT}=5V$, $T_A = 25^{\circ}C$

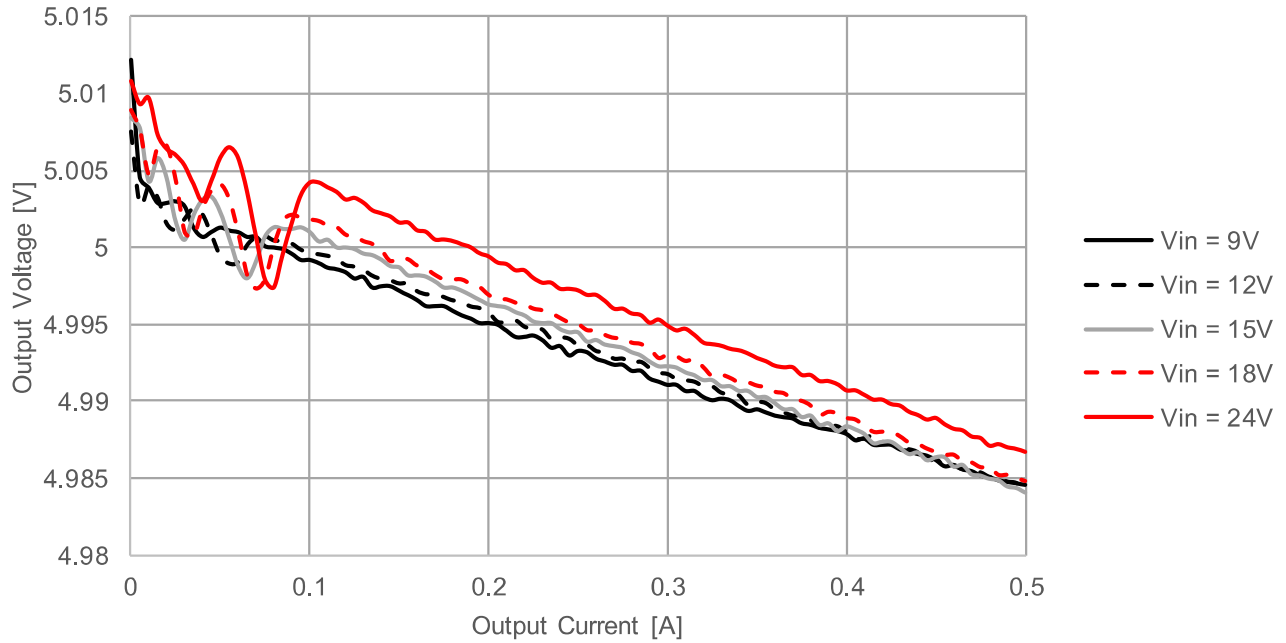

173950578 Load Regulation $V_{OUT}=5V$, $T_A = 85^{\circ}C$

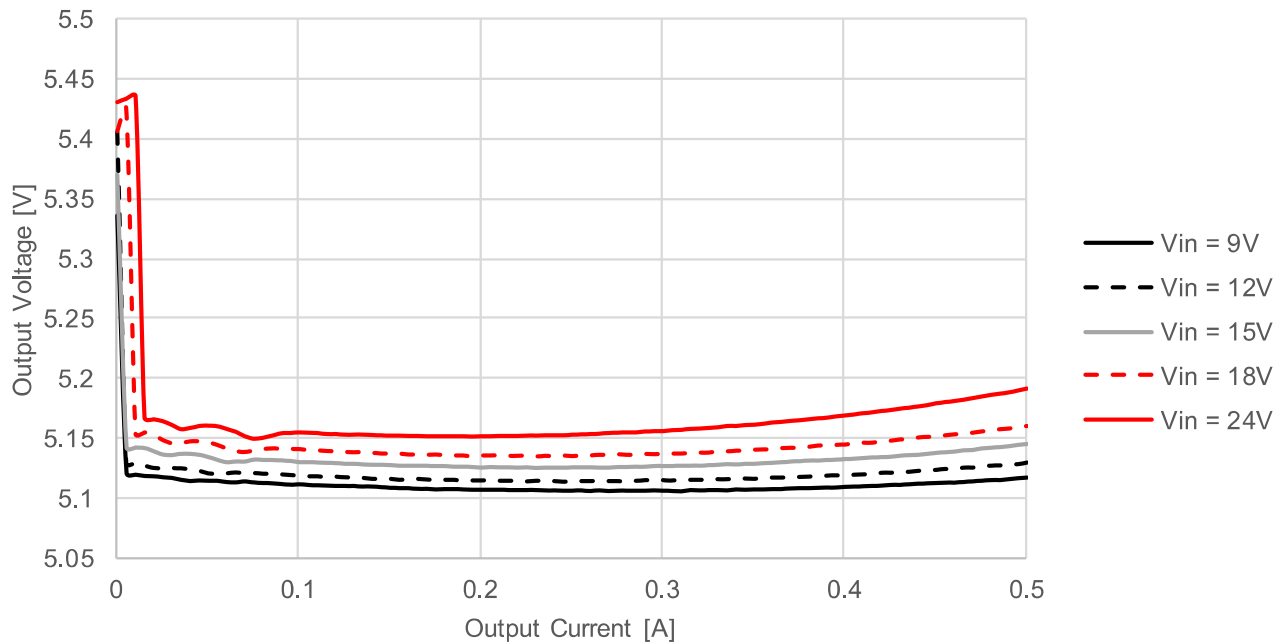

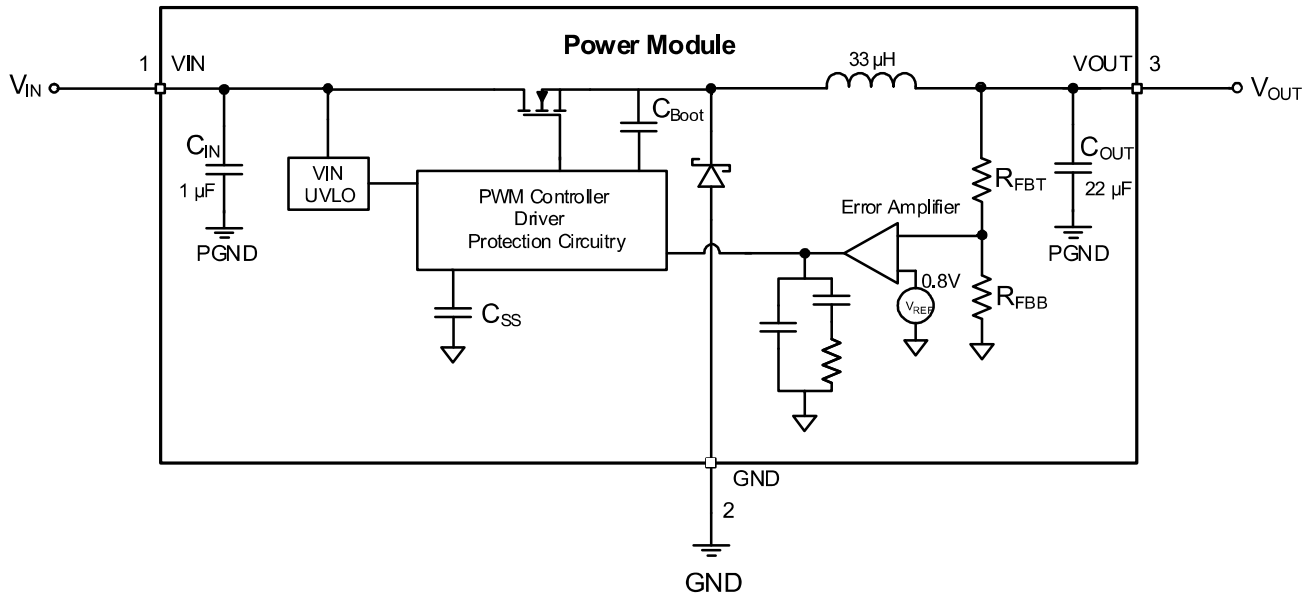
BLOCK DIAGRAM**CIRCUIT DESCRIPTION**

The MagI³C power modules 173950x78 are based on a non-synchronous step-down regulator with integrated MOSFET, free-wheeling diode, power inductor, input and output capacitors. The control scheme is based on a Current Mode (CM) regulation loop.

The V_{OUT} of the regulator is divided with the internal feedback resistor network and fed into the error amplifier, which compares this signal with the internal 0.8V reference. The error signal is amplified and controls the on-time of a fixed frequency pulse width generator. This signal drives the MOSFET.

The Current Mode architecture features a constant frequency during load steps. Only the on-time is modulated. It is internally compensated and stable with low ESR output capacitors. No external compensation network is required.

This architecture supports fast transient response and very small output voltage ripple values (typ. 10mV) are achieved.



OUTPUT VOLTAGE RIPPLE

The output voltage ripple depends on several parameters. The figure below shows the V_{OUT} ripple at full load and using a 10 μ F MLCC output capacitor. An output voltage ripple of around 10mV is measured under the conditions indicated.

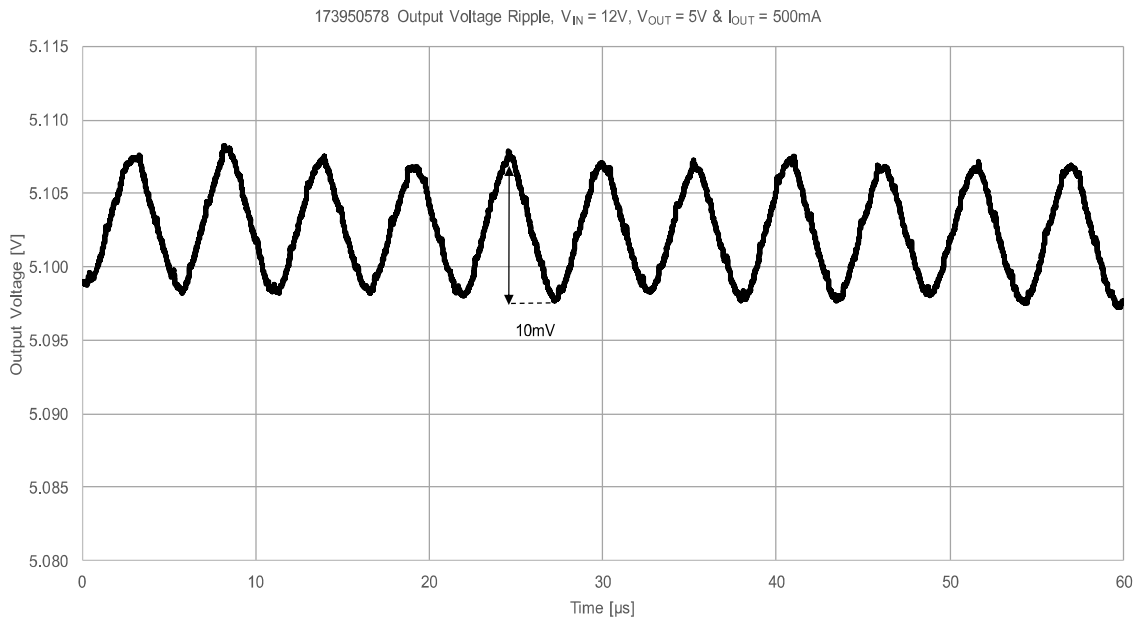
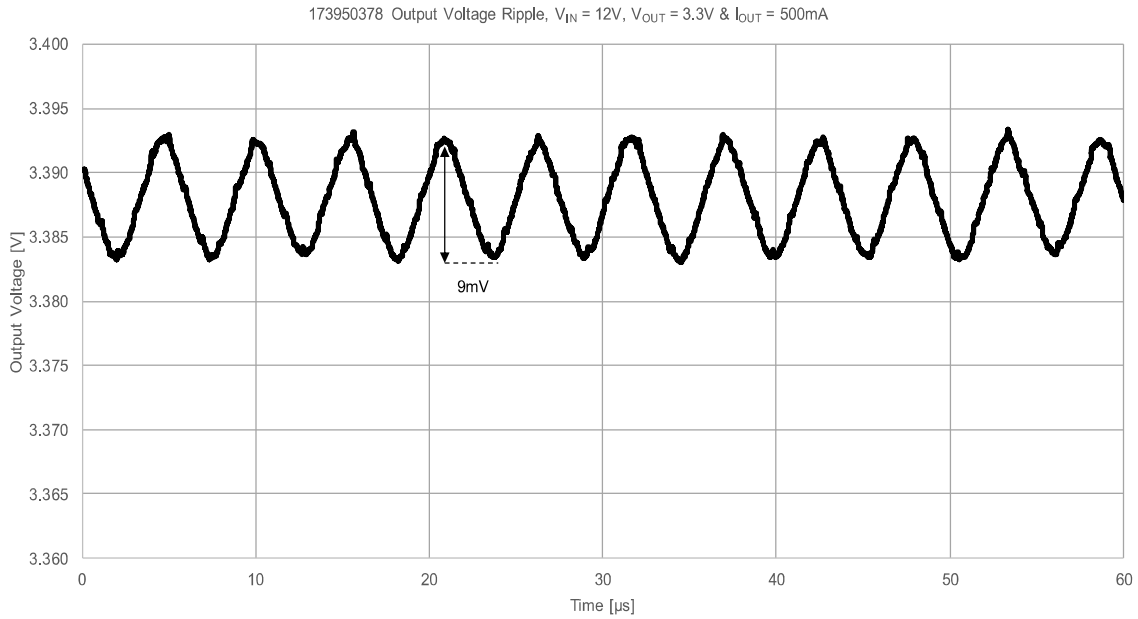



LIGHT LOAD OPERATION

Under light load operation, the device switches from Continuous Conduction Mode (CCM) to Discontinuous Conduction Mode (DCM). The load current where the transition between DCM and CCM takes place can be estimated using the following formula:

$$I_{OUT(DCM)} = \frac{V_{OUT} \cdot \left(1 - \frac{V_{OUT}}{V_{IN}}\right)}{2 \cdot f_{SW} \cdot L} \tag{1}$$

The figures below show the device working in CCM and DCM.

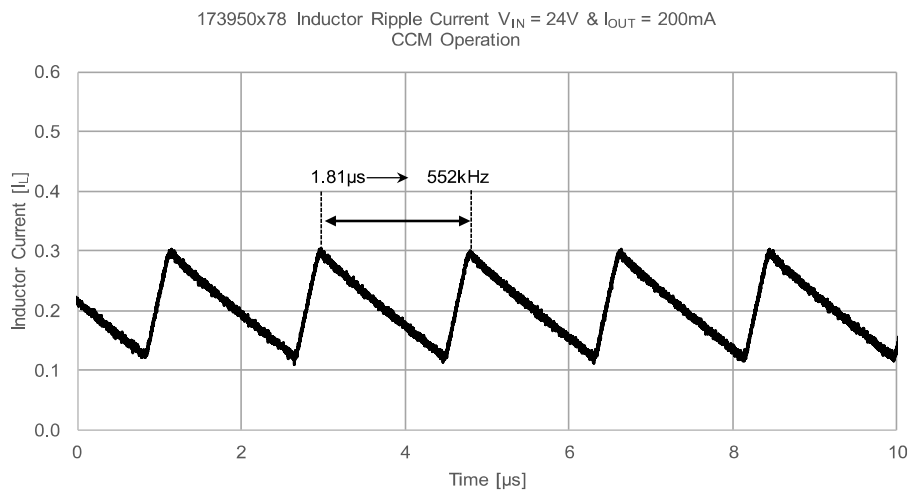
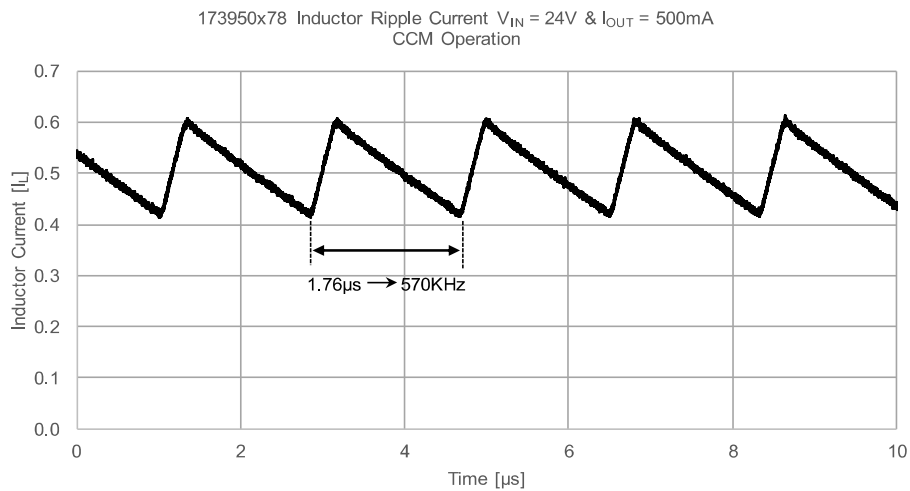



If the load current is further reduced, the device increases the OFF-Time by reducing the switching frequency in order to limit the energy transferred to the output (to both capacitor and load) and therefore keeping the output voltage regulated. The increase in OFF-Time is shown in the figures below.

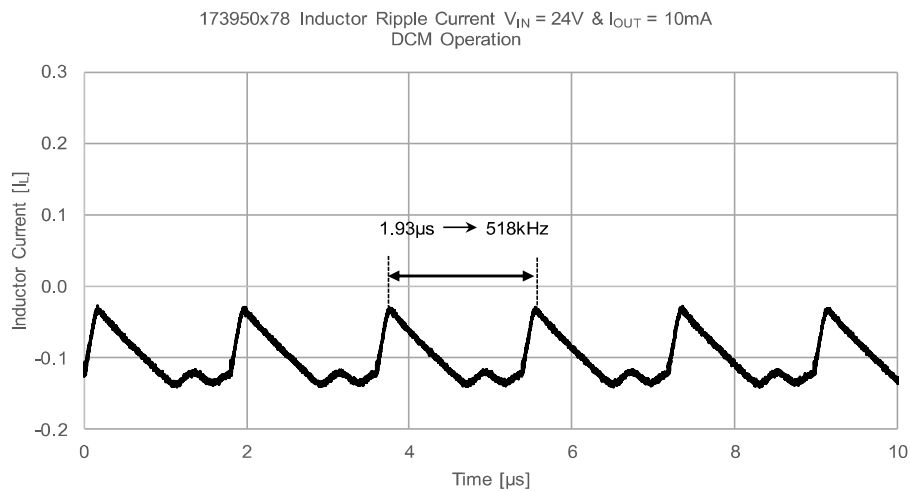
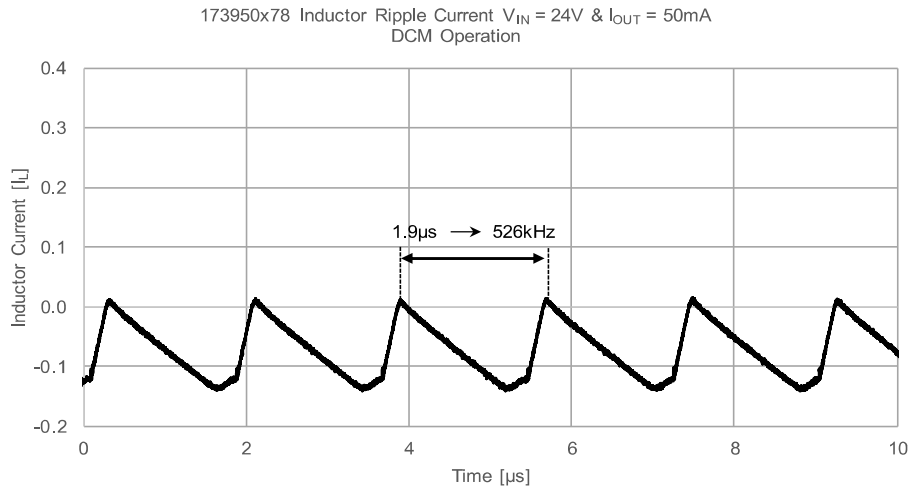



SOFT-START

In order to prevent the output voltage from overshooting during start-up, a soft-start is implemented. The soft-start is internally set for both the 173950378 and 173950578. The figures below show the start-up behavior of the power module with 3.3V and 5V output voltage respectively.

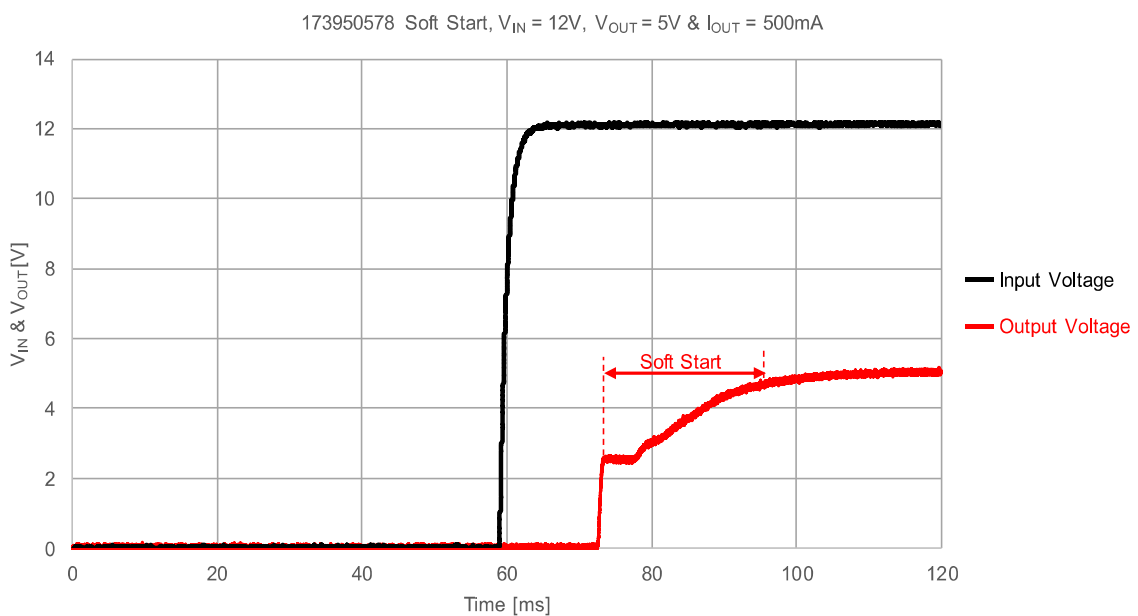
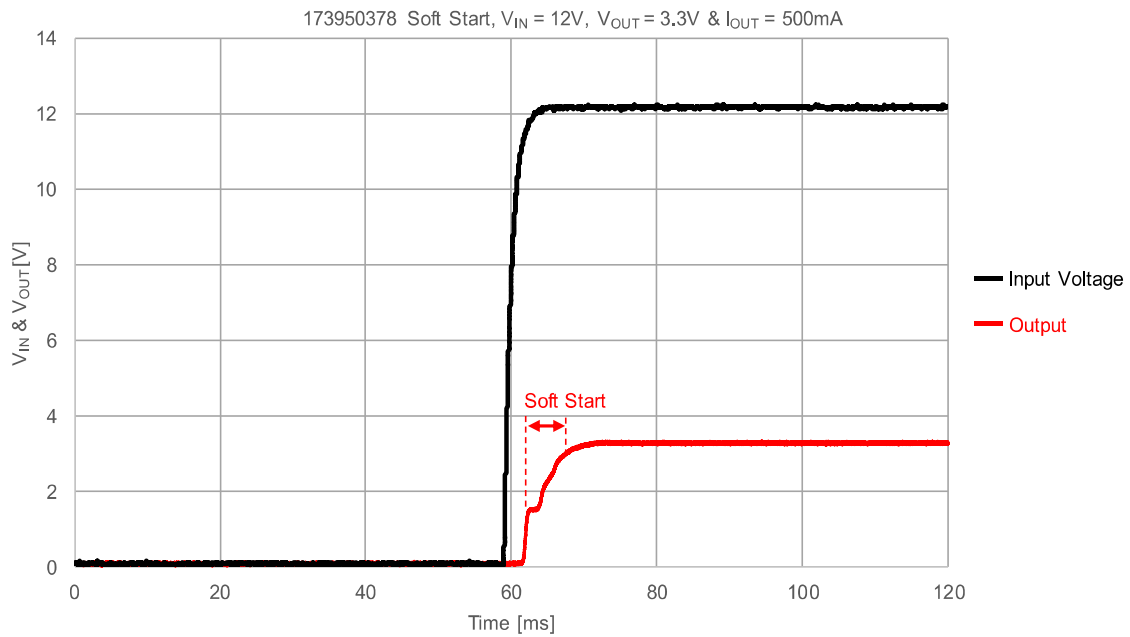

PROTECTIVE FEATURES

Over temperature protection (OTP)

Thermal protection helps prevent catastrophic failures due to accidental device overheating. The junction temperature of the MagI³C Power Module should not be allowed to exceed its maximum ratings. Thermal protection is implemented by an internal thermal shutdown circuit which activates at 165°C (typ.), causing the device to enter a low power standby state. In this state the MOSFET remains off causing V_{OUT} to fall. Thermal protection helps to prevent catastrophic failures from accidental device overheating. When the junction temperature falls back below 165° (hysteresis is implemented) V_{OUT} rises smoothly and normal operation resumes.

Short circuit protection (SCP)

The short circuit protection is realized via cycle by cycle current monitoring. Recovery from short circuit protection mode occurs during the switching cycle following the removal of the short circuit condition. When the 173950x78 recovers from a short circuit condition, the soft-start is not active. Therefore an overshoot at output voltage can be observed (see figure below).

Under short circuit condition the input current is limited.

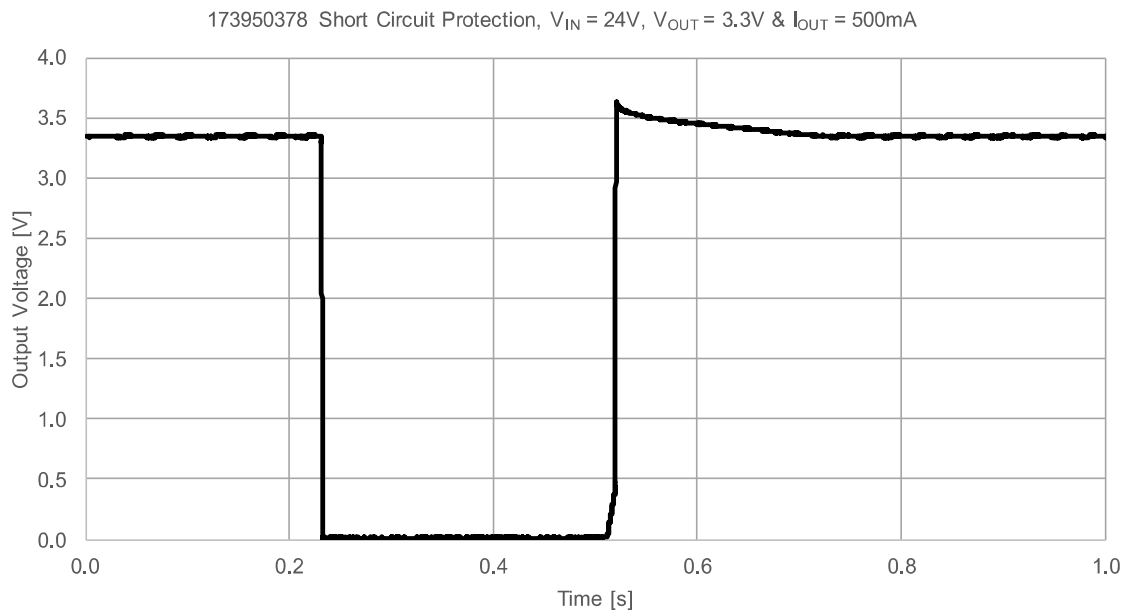

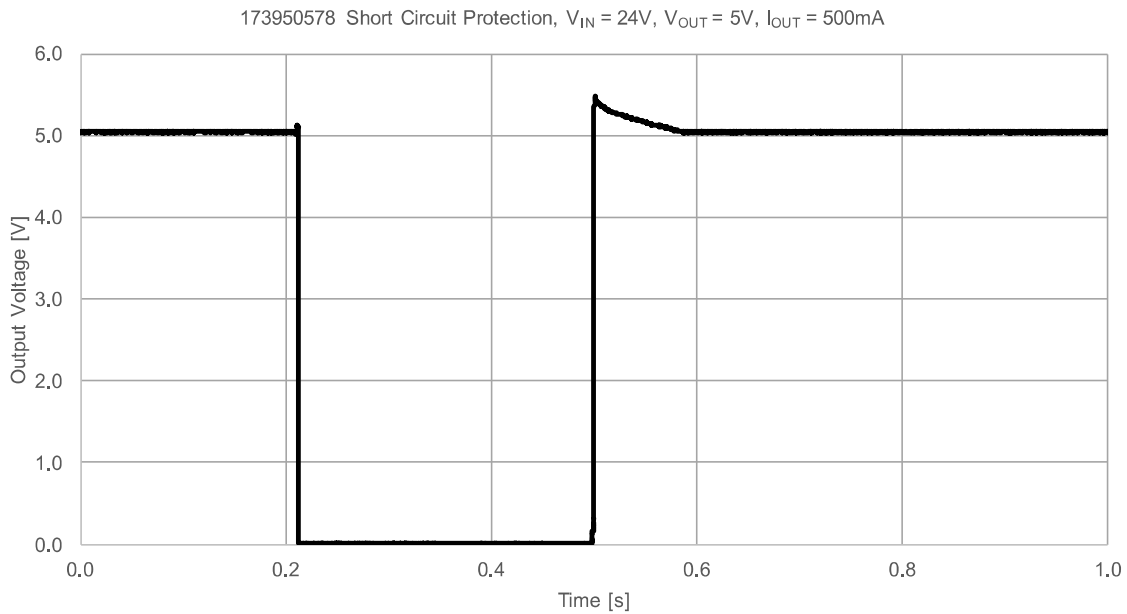

Over current protection (OCP)

For protection against load faults, the 173950x78 incorporates cycle-by-cycle current monitoring. During an overcurrent condition the output current is limited and the output voltage drops. When the overcurrent condition is removed, the output voltage returns to the nominal voltage.

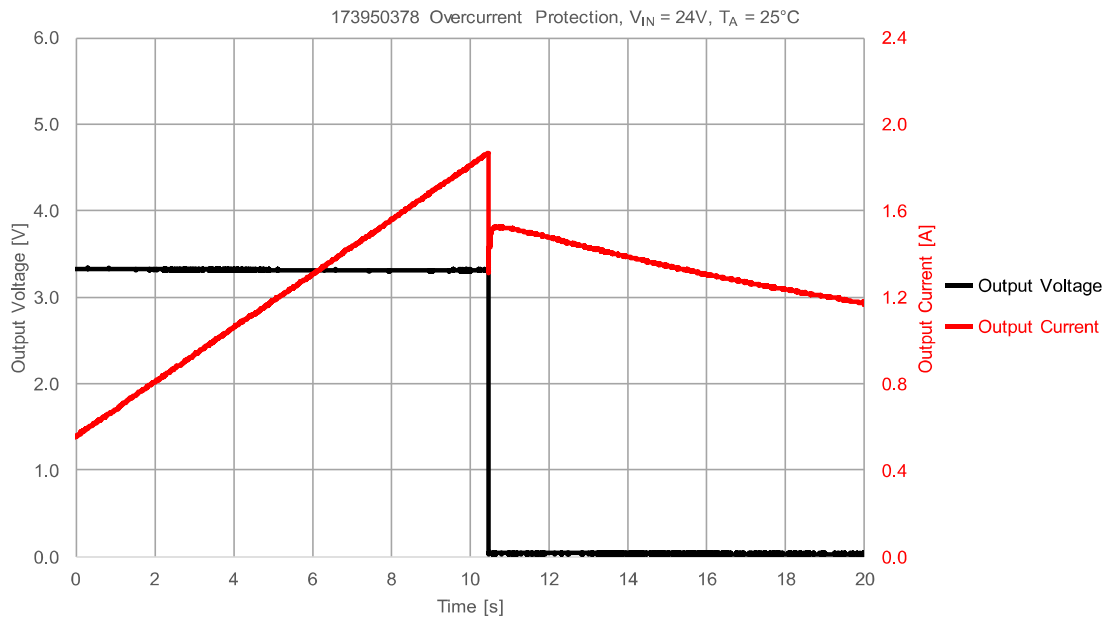

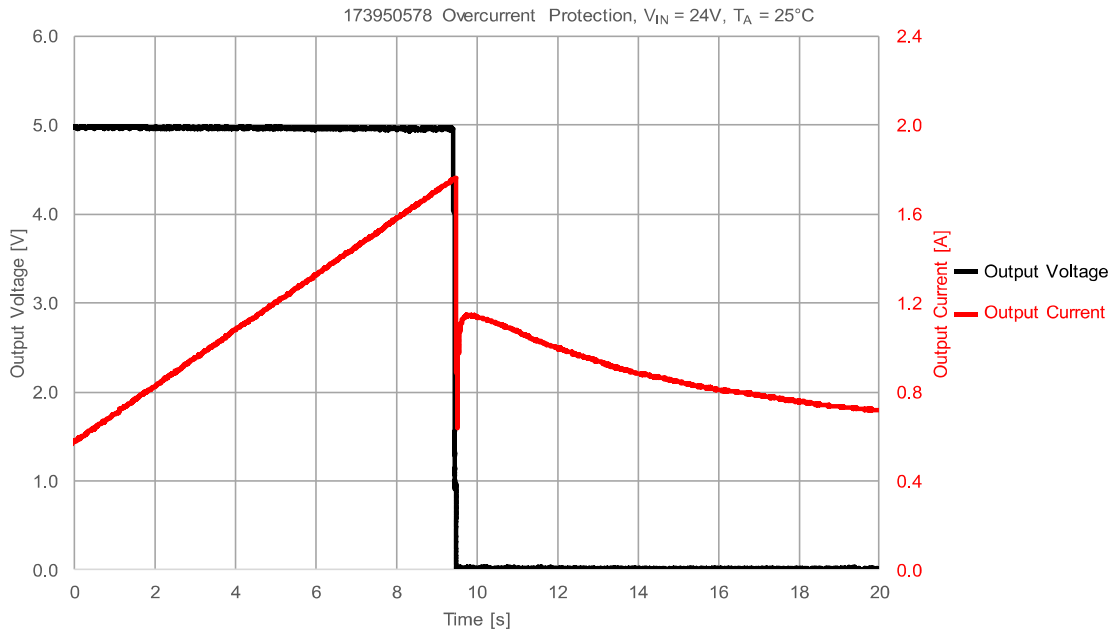

Over voltage protection (OVP)

This protection feature minimizes the occurrence of output voltage overshooting. In the case of an output voltage transient, that reaches the overvoltage threshold, the switching will be stopped by the high side MOSFET, reducing the inductor current to zero. When the output voltage falls below the threshold, the high side MOSFET is again enabled thus increasing the inductor current.

The figure below shows an example, in which it can be seen how the inductor current is reduced to zero when an over voltage transient is detected at the feedback node.

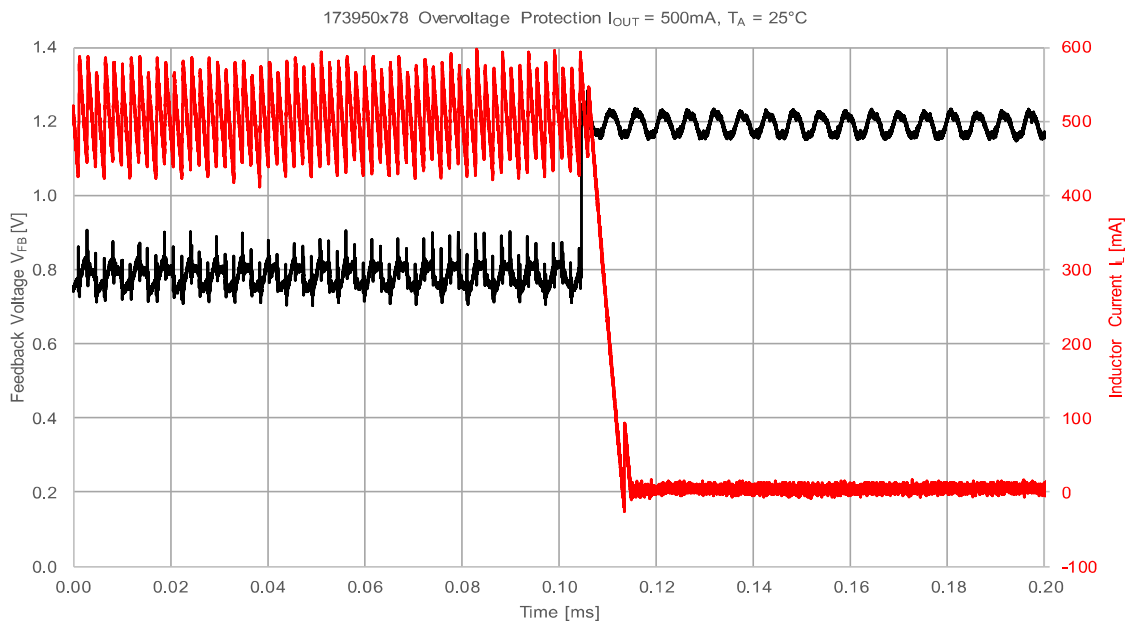

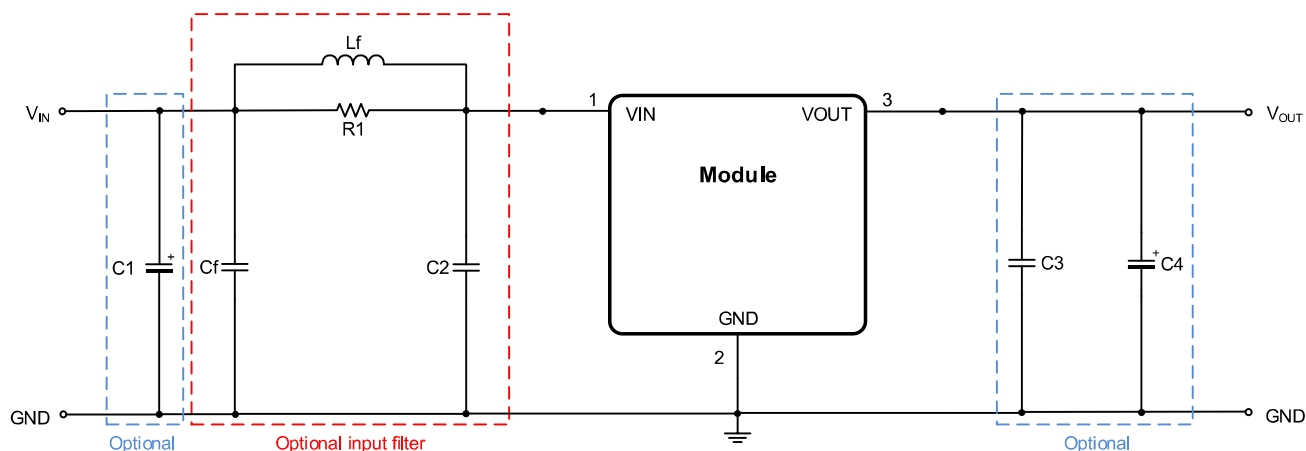
EVALUATION BOARD SCHEMATIC (17800FDSM v.1.0)

The 17950x78 integrates both the input and output capacitors. Therefore, additional external input/output capacitors are normally not required.

The additional 100 μ F aluminum electrolytic capacitor C1 is mounted as termination of the supply line and provides a slight damping of possible oscillations of the series resonance circuit represented by the inductance of the supply line and the input capacitance. This capacitor also prevents voltage overshoot during start up.

The additional MLCC C_f is part of the input filter and is not mounted on the board. The inductor L_f is not mounted too (see recommended part number in the table below). A zero ohm resistor (R1) is mounted in parallel with L_f . In case the input filter is placed, R1 must be removed and an appropriate L_f mounted.

Although the 17950x78 do not need any external output capacitor, in case particular application requirements are demanding additional capacitance, the evaluation board gives the possibility to place further capacitors at the output: C3 (MLCC). This capacitor allows fine tuning of load transient voltage response.

Bill of Material

Designator	Description	Quantity	Order Code	Manufacturer
IC1	MagI ³ C Power Module (not mounted)	1	171950x78	Würth Elektronik
C1	Aluminum electrolytic capacitor, ATG5 family, 100 μ F/50V	1	860010674014	Würth Elektronik
C2	Ceramic chip capacitor, 4.7 μ F/50V/X7R, 0805 (not mounted)	optional	885012208094	Würth Elektronik
C3	Ceramic chip capacitor (not mounted)	optional		
C4	Surface mounted electrolytic, WCAP-PSLP 220 μ F/10V	1	875105244013	Würth Elektronik
C_f	Ceramic chip capacitor 1 μ F/50V X7R, 0805 (not mounted)	optional	885012108021	Würth Elektronik
L_f	Filter inductor, 22 μ H, PD2 (not mounted)	optional	744774122	Würth Elektronik
R1	SMD bridge 0 Ω resistance	1		

Filter suggestion for conducted EMI

The input filter shown in the schematic below is recommended to achieve conducted compliance according to EN55032 CISPR32 Class B (see results on page 7).

For radiated EMI the input filter is not necessary. It is only used to comply with the setup recommended in the norms.

FILTER SETUP: SHORT WIRE:

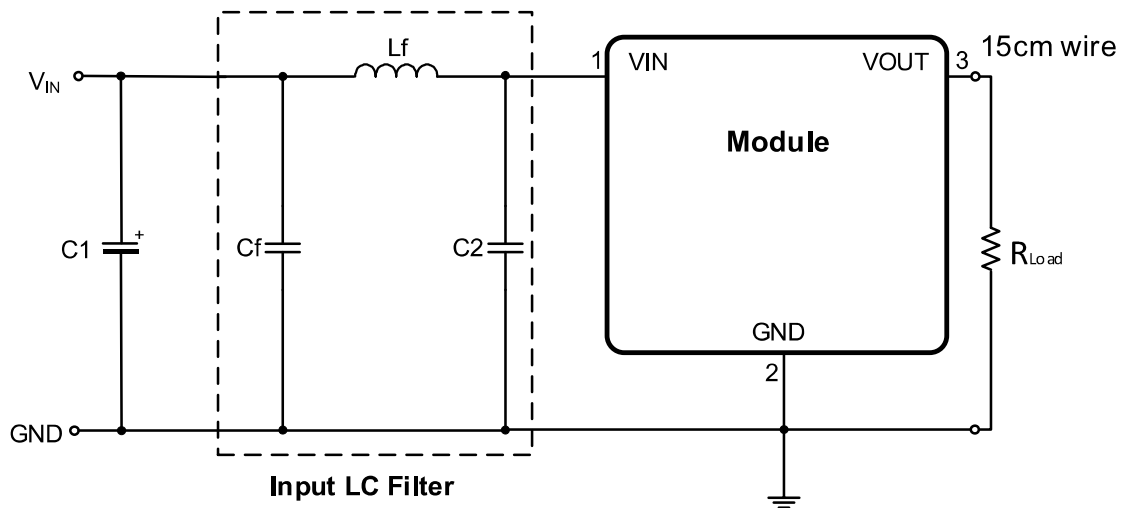

Bill of Material of the Input LC Filter (VIN = 24V, VOUT = 3.3V & 5V, IOUT = 500mA)

Designator	Description	Order Code	Manufacturer
C ₂	Filter MLCC capacitor 4.7µF/50V/X7R	885012208094	Würth Elektronik
C _f	Filter MLCC capacitor 4.7µF/50V/X7R	885012208094	Würth Elektronik
L _f	Filter inductor, 10µH, PD2 family, I _{SAT} = 1.74A , I _R = 1.45A	74477310	Würth Elektronik

FILTER SETUP: LONG WIRE:

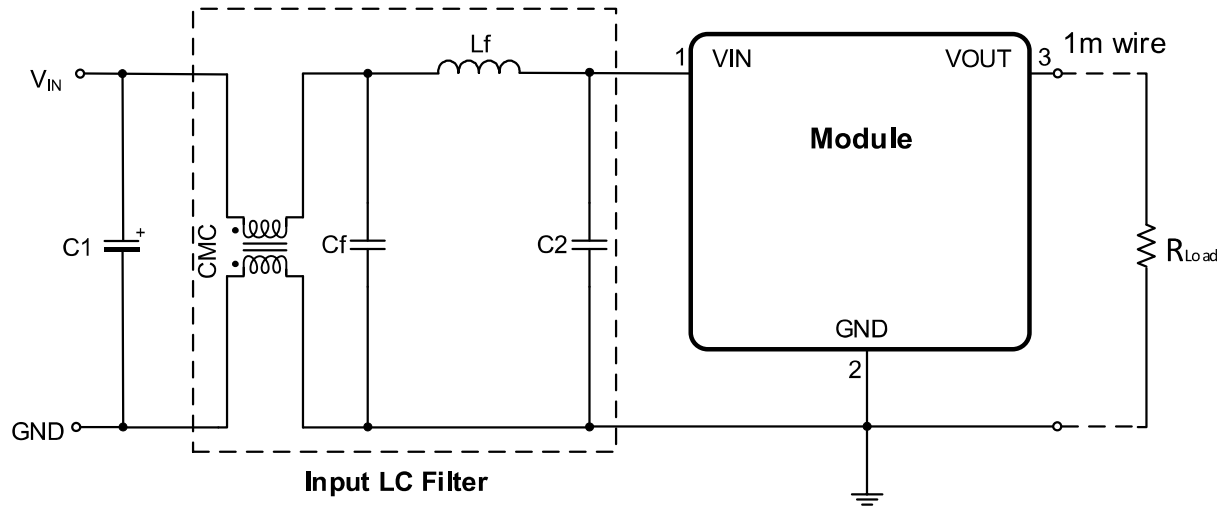

Bill of Material of the Input LC Filter ($V_{IN} = 24V$, $V_{OUT} = 3.3V$ & $5V$, $I_{OUT} = 500mA$)

Designator	Description	Order Code	Manufacturer
C ₂	Filter MLCC capacitor 4.7µF/50V/X7R	885012208094	Würth Elektronik
C _f	Filter MLCC capacitor 4.7µF/50V/X7R	885012208094	Würth Elektronik
L _f	Filter inductor, 10µH, PD2 family, I _{SAT} = 1.74A , I _R = 1.45A	74477310	Würth Elektronik
CMC	Common Mode Choke, 1000µH, SL2 family	744222	Würth Elektronik

Generating negative output voltage

Many industrial applications require negative voltages. The 173950x78 can easily provide a negative voltage using the circuit shown below.

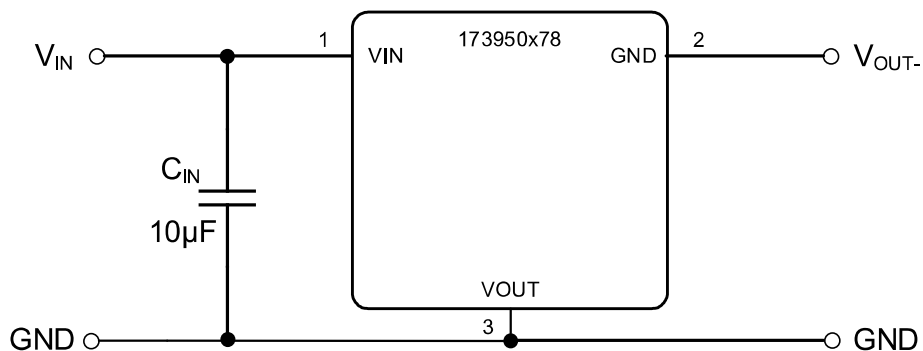

It is important to be aware that in this configuration the 173950x78 must withstand the sum of the input voltage and the absolute value of the output voltage ($V_{IN} + |V_{OUT}|$), instead of just the input voltage. This means that the maximum operating voltage should be limited to $28V - |V_{OUT}|$ (e.g. if the 171950578 is used in this configuration, the input voltage should not exceed 23V).

Moreover, the maximum output current of this configuration is no longer 0.5A, instead it must be reduced according to the below mentioned formula (see also the graph below):

$$I_{OUT-} = (1 - D) \cdot I_{OUT} \quad (1)$$

where D is the duty cycle, in this case defined according to:

$$D = \frac{|V_{OUT}|}{V_{IN} + |V_{OUT}|} \quad (2)$$

Starting Condition for generating negative output voltage:

$$V_{IN_MIN} = 4.75V (3.3V_{OUT}) \text{ \& } 6.5V (5 V_{OUT})$$

$$I_{OUT_MIN} = 20mA (3.3 \text{ \& } 5V_{OUT})$$

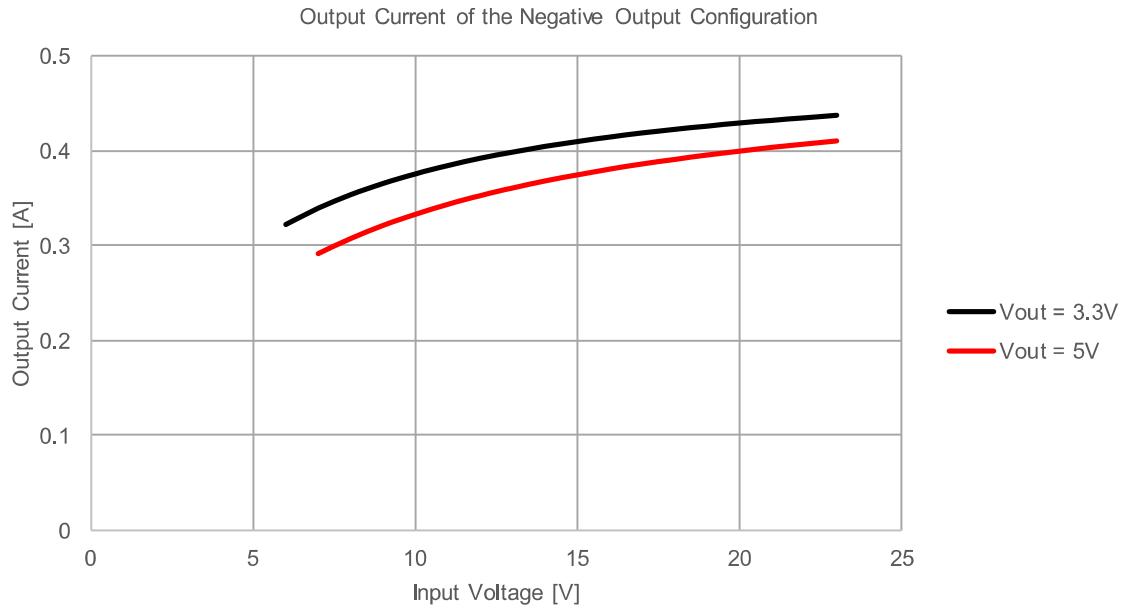

Compared with a standard positive buck configuration, the negative output buck contains an additional critical loop (between V_{IN} and V_{OUT}), which needs an additional capacitor C_{IN} , as shown in the circuit above.



Generating complementary output voltage

Another common requirement in industrial application is to provide a complementary voltage (e.g. $\pm 5V$). The circuit below shows how this target can be achieved simply combining a 173950x78 used in a standard configuration (delivering a positive output voltage) with the above mentioned solution for negative voltages.

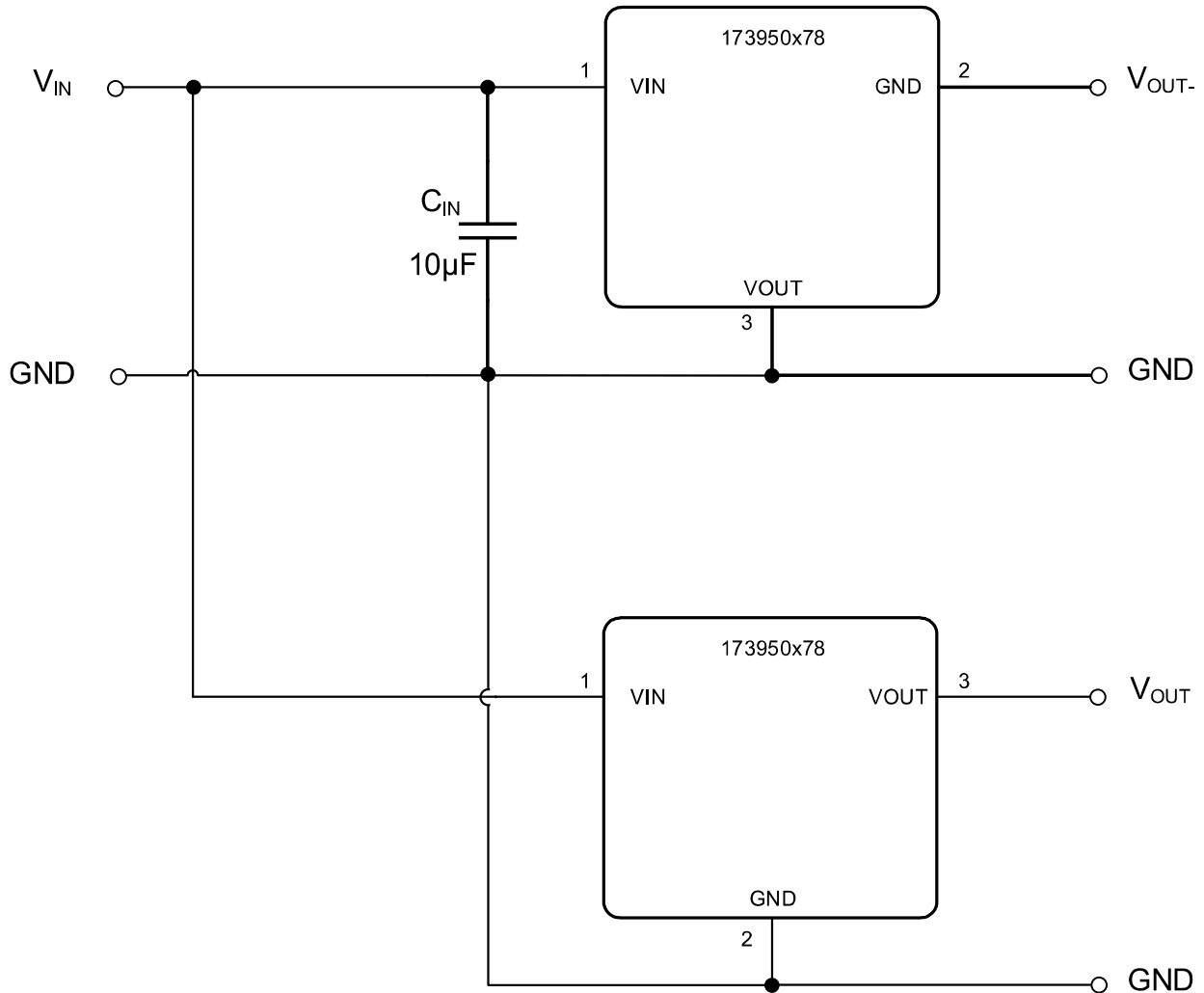

Complementary output voltage



WAVE SOLDER PROFILE

Profile Feature	Old standard (Pb)	New (Pb-free)
Time within peak temperature t_p	10 s	10 s
Average ramp-up rate	~ 200 °C/s	~ 200 °C/s
Final preheat temperature T_s	~ 130 °C	~ 130 °C
Peak temperature T_p	+ 235 °C	+ 260 °C
Ramp-down rate	-5 °C/s	-5 °C/s
Heating rate during preheat	4 °C/s	4 °C/s

Wave Solder Diagram:

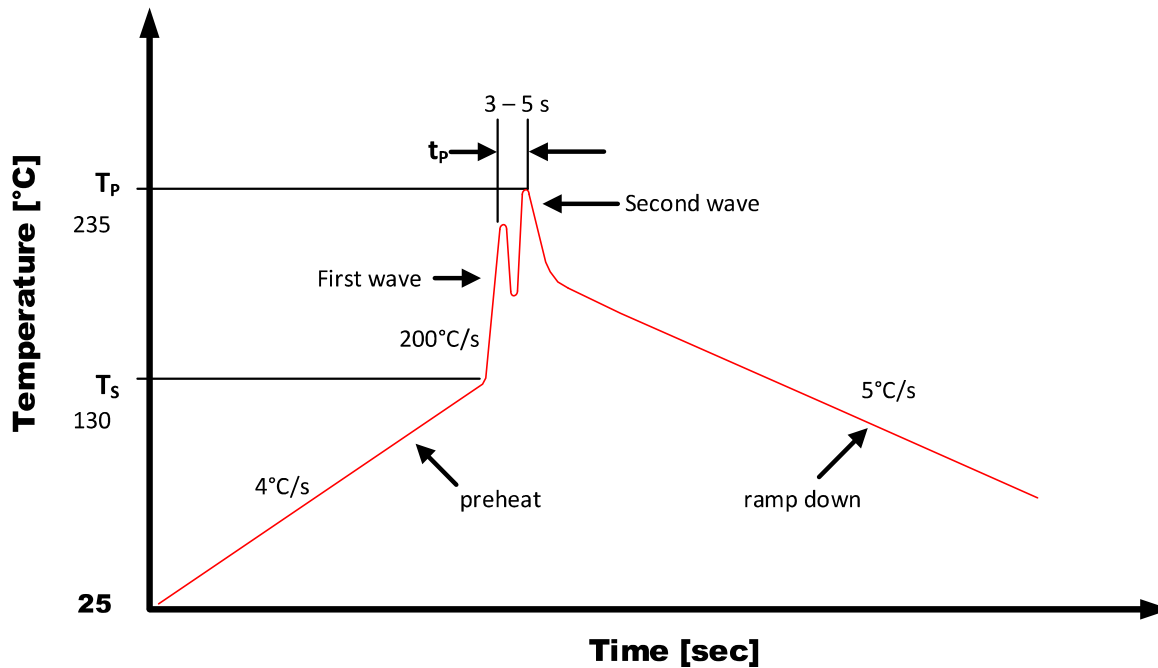

173950x78

MagI³C Power Module

FDSM – Fixed Step Down Regulator Module



WÜRTH
ELEKTRONIK
MORE THAN
YOU EXPECT

PHYSICAL DIMENSIONS

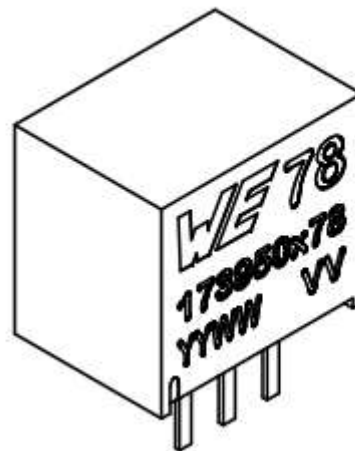
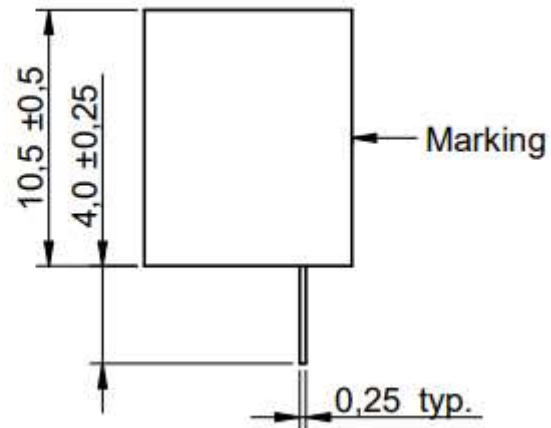
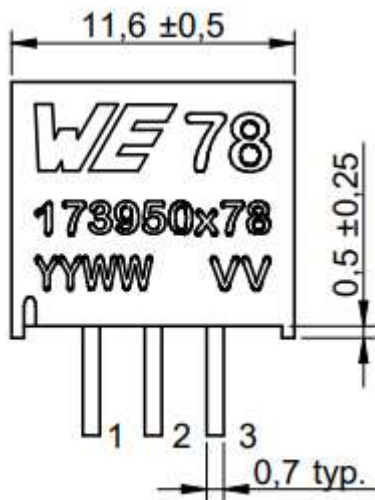
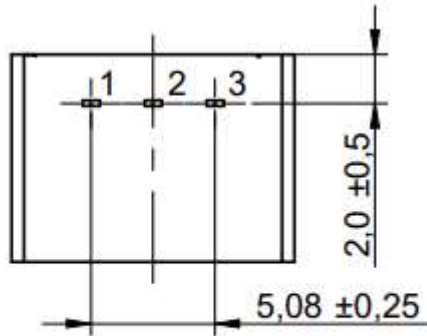

173950x78

MagI³C Power Module

FDSM – Fixed Step Down Regulator Module



WÜRTH
ELEKTRONIK
MORE THAN
YOU EXPECT

RECOMMENDED DRILL HOLES

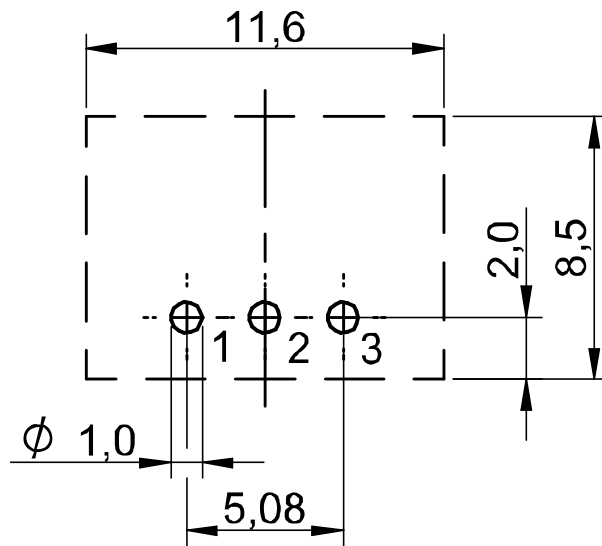

All dimensions in mm

TUBE

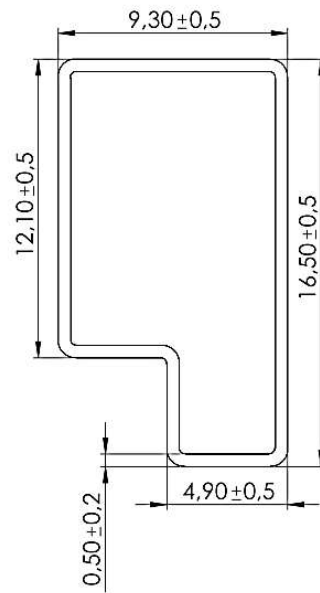

173950x78

MagI³C Power Module

FDSM – Fixed Step Down Regulator Module



WÜRTH
ELEKTRONIK
MORE THAN
YOU EXPECT

DOCUMENT HISTORY

Revision	Date	Description	Comment
1.0	Dec 2014	Final version	Final version
2.0	May 2019	Updated version released	Added: <ul style="list-style-type: none">- EMI measurements with different setups- additional circuit and application description
3.0	May 2022	PCN	<ol style="list-style-type: none">1. Updated front page drawing. (page 1)a2. Updated pinout drawing to include pin 1 marking. (page 2)3. Updated physical dimensions drawings to include pin 1 marking. (page 37)

173950x78

MagI³C Power Module

FDSM – Fixed Step Down Regulator Module



WÜRTH
ELEKTRONIK
MORE THAN
YOU EXPECT

CAUTIONS AND WARNINGS

The following conditions apply to all goods within the product series of MagI³C Power Modules of Würth Elektronik eiSos GmbH & Co. KG:

General:

- This electronic component is designed and manufactured for use in general electronic equipment.
- Würth Elektronik must be asked for written approval (following the PPAP procedure) before incorporating the components into any equipment in fields such as military, aerospace, aviation, nuclear control, submarine, transportation (automotive control, train control, ship control), transportation signal, disaster prevention, medical, public information network, etc. where higher safety and reliability are especially required and/or if there is the possibility of direct damage or human injury.
- Electronic components that will be used in safety-critical or high-reliability applications, should be pre-evaluated by the customer.
- The component is designed and manufactured to be used within the datasheet specified values. If the usage and operation conditions specified in the datasheet are not met, the component may be damaged or dissolved.
- Do not drop or impact the components as material of the body, pins or termination may flake apart.
- Würth Elektronik products are qualified according to international standards, which are listed in each product reliability report. Würth Elektronik does not warrant any customer qualified product characteristics beyond Würth Elektronik's specifications, for its validity and sustainability over time.
- All technical specifications for standard products also apply to customer specific products.
- Customer acknowledges and agrees that it is solely responsible for compliance with all legal, regulatory and safety-related requirements concerning its products, and any use of Würth Elektronik eiSos GmbH & Co. KG components in its applications, notwithstanding any applications-related information or support that may be provided by Würth Elektronik eiSos GmbH & Co. KG. Customer represents and agrees that it has all the necessary expertise to create and implement safeguards which anticipate dangerous consequences of failures, monitor failures and their consequences lessen the likelihood of failures that might cause harm and take appropriate remedial actions. Customer will fully indemnify Würth Elektronik eiSos and its representatives against any damages arising out of the use of any Würth Elektronik eiSos GmbH & Co. KG components in safety-critical applications.

Product specific:

Soldering:

- The solder profile must comply with the technical product specifications. All other profiles will void the warranty.
- All other soldering methods are at the customer's own risk.

Cleaning and Washing:

- Residual washing varnish agent that is used during the production to clean the application might change the characteristics of the body, pins or termination. The washing varnish agent may have a negative effect on the long term function of the component.
- Using a brush during the cleaning process may break the component. Therefore, we do not recommend using a brush during the PCB cleaning process.

**Potting and Coating:**

- If the component is potted in the customer application, the potting material might shrink or expand during and after hardening. Shrinking could lead to an incomplete seal, allowing contaminants into the component. Expansion could damage the components or parts of it. We recommend a manual inspection after potting to avoid these effects.
- Conformal coating may affect the product performance.

Storage Conditions:

- A storage of Würth Elektronik products for longer than 12 months is not recommended. Within other effects, the terminals may suffer degradation, resulting in bad solderability. Therefore, all products shall be used within the period of 12 months based on the day of shipment.
- Do not expose the components to direct sunlight.
- The storage conditions in the original packaging are defined according to DIN EN 61760-2.
- For a moisture sensitive component, the storage condition in the original packaging is defined according to IPC/JEDEC -J-STD-033. It is also recommended to return the component to the original moisture proof bag and reseal the moisture proof bag again.
- ESD prevention methods need to be followed for manual handling and processing by machinery.
- The storage conditions stated in the original packaging apply to the storage time and not to the transportation time of the components.

Packaging:

- The packaging specifications apply only to purchase orders comprising whole packaging units. If the ordered quantity exceeds or is lower than the specified packaging unit, packaging in accordance with the packaging specifications cannot be ensured.

Handling:

- Violation of the technical product specifications such as exceeding the absolute maximum ratings will void the warranty and also the conformance to regulatory requirements.
- The edge castellation is designed and made for prototyping, i.e. hand soldering purposes, only.
- The applicable country regulations and specific environmental regulations must be observed.
- Do not disassemble the component. Evidence of tampering will void the warranty.
- The temperature rise of the component must be taken into consideration. The operating temperature is comprised of ambient temperature and temperature rise of the component.
The operating temperature of the component shall not exceed the maximum temperature specified.
- Direct mechanical impact to the component must be prevented as the material of the body, pins or termination could flake or, in the worst case, could break. As these devices are sensitive to electrostatic discharge, proper IC Handling Procedures must be followed.

These cautions and warnings comply with the state of the scientific and technical knowledge and are believed to be accurate and reliable. However, no responsibility is assumed for inaccuracies or incompleteness.

173950x78

MagI³C Power Module

FDSM – Fixed Step Down Regulator Module



WÜRTH
ELEKTRONIK
MORE THAN
YOU EXPECT

IMPORTANT NOTES

General Customer Responsibility

Some goods within the product range of Würth Elektronik eiSos GmbH & Co. KG contain statements regarding general suitability for certain application areas. These statements about suitability are based on our knowledge and experience of typical requirements concerning the areas, serve as general guidance and cannot be estimated as binding statements about the suitability for a customer application. The responsibility for the applicability and use in a particular customer design is always solely within the authority of the customer. Due to this fact it is up to the customer to evaluate, where appropriate to investigate and decide whether the device with the specific product characteristics described in the product specification is valid and suitable for the respective customer application or not. Accordingly, the customer is cautioned to verify that the datasheet is current before placing orders.

Customer Responsibility Related to Specific, in Particular Safety-Relevant, Applications

It has to be clearly pointed out that the possibility of a malfunction of electronic components or failure before the end of the usual lifetime cannot be completely eliminated in the current state of the art, even if the products are operated within the range of the specifications. In certain customer applications requiring a very high level of safety and especially in customer applications in which the malfunction or failure of an electronic component could endanger human life or health it must be ensured by most advanced technological aid of suitable design of the customer application that no injury or damage is caused to third parties in the event of malfunction or failure of an electronic component.

Best Care and Attention

Any product-specific notes, warnings and cautions must be strictly observed. Any disregard will result in the loss of warranty.

Customer Support for Product Specifications

Some products within the product range may contain substances which are subject to restrictions in certain jurisdictions in order to serve specific technical requirements. Necessary information is available on request. In this case the field sales engineer or the internal sales person in charge should be contacted who will be happy to support in this matter.

Product R&D

Due to constant product improvement product specifications may change from time to time. As a standard reporting procedure of the Product Change Notification (PCN) according to the JEDEC-Standard we inform about minor and major changes. In case of further queries regarding the PCN, the field sales engineer or the internal sales person in charge should be contacted. The basic responsibility of the customer as per Section 1 and 2 remains unaffected.

Product Life Cycle

Due to technical progress and economical evaluation we also reserve the right to discontinue production and delivery of products. As a standard reporting procedure of the Product Termination Notification (PTN) according to the JEDEC-Standard we will inform at an early stage about inevitable product discontinuance. According to this we cannot guarantee that all products within our product range will always be available. Therefore it needs to be verified with the field sales engineer or the internal sales person in charge about the current product availability expectancy before or when the product for application design-in disposal is considered. The approach named above does not apply in the case of individual agreements deviating from the foregoing for customer-specific products.

173950x78

MagI³C Power Module

FDSM – Fixed Step Down Regulator Module



**WÜRTH
ELEKTRONIK**
MORE THAN
YOU EXPECT

Property Rights

All the rights for contractual products produced by Würth Elektronik eiSos GmbH & Co. KG on the basis of ideas, development contracts as well as models or templates that are subject to copyright, patent or commercial protection supplied to the customer will remain with Würth Elektronik eiSos GmbH & Co. KG. Würth Elektronik eiSos GmbH & Co. KG does not warrant or represent that any license, either expressed or implied, is granted under any patent right, copyright, mask work right, or other intellectual property right relating to any combination, application, or process in which Würth Elektronik eiSos GmbH & Co. KG components or services are used.

General Terms and Conditions

Unless otherwise agreed in individual contracts, all orders are subject to the current version of the "General Terms and Conditions of Würth Elektronik eiSos Group", last version available at www.we-online.com.