

# Modular timers 1 - 6 - 8 - 16 A

**80**  
SERIES



Building automation



Elevators and lifts



Automation for blinds, grilles and shutters



Hoists and cranes



Panels for electrical distribution



Door and gate openers





**Multi-function and mono-function timer range**

- 80.01 - Multi-function & multi-voltage**
- 80.11 - On-delay, multi-voltage**

- 17.5 mm wide
- Six time scales from 0.1 s to 24 h
- High input/output isolation
- 35 mm rail (EN 60715) mount
- "Blade + cross" - both flat blade and cross head screw drivers can be used to adjust the range and function selectors, the timing trimmer, and to disengage the rail mounting clip
- New multi-voltage versions with "PWM clever" technology

80.01 / 80.11  
Screw terminal



FOR UL RATINGS SEE:

"General technical information" page V

For outline drawing see page 9

**Contact specification**

|   |           |             |             |
|---|-----------|-------------|-------------|
| Contact configuration                       |           | 1 CO (SPDT) | 1 CO (SPDT) |
| Rated current/Maximum peak current          | A         | 16/30       | 16/30       |
| Rated voltage/<br>Maximum switching voltage | V AC      | 250/400     | 250/400     |
| Rated load AC1                              | VA        | 4000        | 4000        |
| Rated load AC15 (230 V AC)                  | VA        | 750         | 750         |
| Single phase motor rating (230 V AC)        | kW        | 0.55        | 0.55        |
| Breaking capacity DC1: 30/110/220 V         | A         | 16/0.3/0.12 | 16/0.3/0.12 |
| Minimum switching load                      | mW (V/mA) | 500 (10/5)  | 500 (10/5)  |
| Standard contact material                   |           | AgNi        | AgNi        |

**Supply specification**

|                                   |                 |            |            |
|-----------------------------------|-----------------|------------|------------|
| Nominal voltage (U <sub>N</sub> ) | V AC (50/60 Hz) | 12...240   | 24...240   |
|                                   | V DC            | 12...240   | 24...240   |
| Rated power AC/DC                 | VA (50 Hz)/W    | < 1.8/< 1  | < 1.8/< 1  |
| Operating range                   | V AC            | 10.8...265 | 16.8...265 |
|                                   | V DC            | 10.8...265 | 16.8...265 |

**Technical data**

|                                      |        |   |                      |
|--------------------------------------|--------|---|----------------------|
| Specified time range                 |        | (0.1...2)s, (1...20)s, (0.1...2)min, (1...20)min, (0.1...2)h, (1...24)h |                      |
| Repeatability                        | %      | ± 1   | ± 1                  |
| Recovery time                        | ms     | 100   | 100                  |
| Minimum control impulse              | ms     | 50  | —                    |
| Setting accuracy-full range          | %      | ± 5   | ± 5                  |
| Electrical life at rated load in AC1 | cycles | 50 · 10 <sup>3</sup>  | 50 · 10 <sup>3</sup> |
| Ambient temperature range            | °C     | -20...+60   | -20...+60            |
| Protection category                  |        | IP 20   | IP 20                |

**Approvals** (according to type)



**80.01**



- Multi-voltage
- Multi-function

- AI:** On-delay
- DI:** Interval
- SW:** Symmetrical flasher (starting pulse on)
- BE:** Off-delay with control signal
- CE:** On- and off-delay with control signal
- DE:** Interval with control signal on

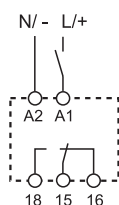

Wiring diagram  
(without control signal)

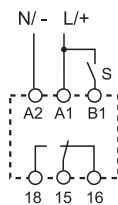

Wiring diagram  
(with control signal)

**80.11**



- Multi-voltage
- Mono-function

- AI:** On-delay

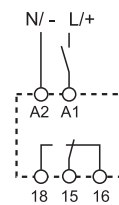

Wiring diagram  
(without control signal)

**Mono-function timer range**

- 80.21 - Interval, multi-voltage**
- 80.41 - Off-delay with control signal, multi-voltage**
- 80.91 - Asymmetrical flasher, multi-voltage**

- 17.5 mm wide
- Six time scales from 0.1 s to 24 h
- High input/output isolation
- 35 mm rail (EN 60715) mount
- "Blade + cross" - both flat blade and cross head screw drivers can be used to adjust the range and function selectors, the timing trimmer, and to disengage the rail mounting clip
- New multi-voltage versions with "PWM clever" technology

80.21 / 80.41 / 80.91  
Screw terminal



FOR UL RATINGS SEE:  
"General technical information" page V

For outline drawing see page 9

**80.21**



- Multi-voltage
- Mono-function

**DI:** Interval

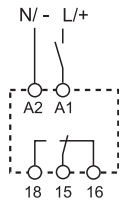

Wiring diagram  
(without control signal)

**80.41**



- Multi-voltage
- Mono-function

**BE:** Off-delay with control signal

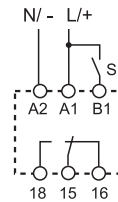

Wiring diagram  
(with control signal)

**80.91**



- Multi-voltage
- Mono-function

**LI:** Asymmetrical flasher  
(starting pulse on)

**LE:** Asymmetrical flasher (starting pulse on) with control signal

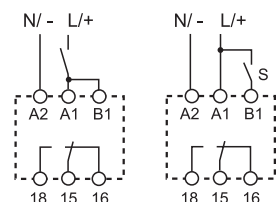

Wiring diagram  
(without control signal)

Wiring diagram  
(with control signal)

**Contact specification**

|   |           |             |             |             |
|---|-----------|-------------|-------------|-------------|
| Contact configuration                       |           | 1 CO (SPDT) | 1 CO (SPDT) | 1 CO (SPDT) |
| Rated current/Maximum peak current          | A         | 16/30       | 16/30       | 16/30       |
| Rated voltage/<br>Maximum switching voltage | V AC      | 250/400     | 250/400     | 250/400     |
| Rated load AC1                              | VA        | 4000        | 4000        | 4000        |
| Rated load AC15 (230 V AC)                  | VA        | 750         | 750         | 750         |
| Single phase motor rating (230 V AC)        | kW        | 0.55        | 0.55        | 0.55        |
| Breaking capacity DC1: 30/110/220 V         | A         | 16/0.3/0.12 | 16/0.3/0.12 | 16/0.3/0.12 |
| Minimum switching load                      | mW (V/mA) | 500 (10/5)  | 500 (10/5)  | 500 (10/5)  |
| Standard contact material                   |           | AgNi        | AgNi        | AgNi        |

**Supply specification**

|                                   |                 |            |            |            |
|-----------------------------------|-----------------|------------|------------|------------|
| Nominal voltage (U <sub>N</sub> ) | V AC (50/60 Hz) | 24...240   | 24...240   | 12...240   |
|                                   | V DC            | 24...240   | 24...240   | 12...240   |
| Rated power AC/DC                 | VA (50 Hz)/W    | < 1.8/< 1  | < 1.8/< 1  | < 1.8/< 1  |
| Operating range                   | V AC            | 16.8...265 | 16.8...265 | 10.8...265 |
|                                   | V DC            | 16.8...265 | 16.8...265 | 10.8...265 |

**Technical data**

|                                      |        |   |                      |                      |
|--------------------------------------|--------|---|----------------------|----------------------|
| Specified time range                 |        | (0.1...2)s, (1...20)s, (0.1...2)min, (1...20)min, (0.1...2)h, (1...24)h |                      |                      |
| Repeatability                        | %      | ± 1   | ± 1                  | ± 1                  |
| Recovery time                        | ms     | 100   | 100                  | 100                  |
| Minimum control impulse              | ms     | —   | 50                   | 50                   |
| Setting accuracy-full range          | %      | ± 5   | ± 5                  | ± 5                  |
| Electrical life at rated load in AC1 | cycles | 50 · 10 <sup>3</sup>  | 50 · 10 <sup>3</sup> | 50 · 10 <sup>3</sup> |
| Ambient temperature range            | °C     | -20...+60   | -20...+60            | -20...+60            |
| Protection category                  |        | IP 20   | IP 20                | IP 20                |

**Approvals** (according to type)



**Multi-function and multi-voltage solid-state output timer**

- 17.5 mm wide
- Six time scales from 0.1 s to 24 h
- High input/output isolation
- 35 mm rail (EN 60715) mount
- Multi-voltage output (24...240 V AC/DC), independent from the input voltage
- "Blade + cross" - both flat blade and cross head screw drivers can be used to adjust the range and function selectors, the timing trimmer, and to disengage the rail mounting clip
- Multi-voltage input with "PWM clever" technology

80.71  
Screw terminal



For outline drawing see page 9

**Output circuit**

|                                  |                |          |
|----------------------------------|----------------|----------|
| Contact configuration            | 1 NO (SPST-NO) |          |
| Rated current                    | A              | 1        |
| Rated voltage                    | V AC/DC        | 24...240 |
| Switching voltage range          | V AC/DC        | 19...265 |
| Rated load AC15                  | A              | 1        |
| Rated load DC1                   | A              | 1        |
| Minimum switching current        | mA             | 0.5      |
| Max. "OFF-state" leakage current | mA             | 0.05     |
| Max. "ON-state" voltage drop     | V              | 2.8      |

**Input circuit**

|                                   |                 |          |
|-----------------------------------|-----------------|----------|
| Nominal voltage (U <sub>N</sub> ) | V AC (50/60 Hz) | 24...240 |
|                                   | V DC            | 24...240 |
| Rated power                       | VA (50 Hz)/W    | 1.3/1.3  |
| Operating range                   | V AC            | 19...265 |
|                                   | V DC            | 19...265 |

**Technical data**

|                             |   |                       |
|-----------------------------|---|-----------------------|
| Specified time range        | (0.1...2)s, (1...20)s, (0.1...2)min, (1...20)min, (0.1...2)h, (1...24)h |                       |
| Repeatability               | %   | ± 1                   |
| Recovery time               | ms  | 100                   |
| Minimum control impulse     | ms  | 50                    |
| Setting accuracy-full range | %   | ± 5                   |
| Electrical life             | cycles  | 100 · 10 <sup>6</sup> |
| Ambient temperature range   | °C  | -20...+50             |
| Protection category         | IP 20   |                       |

**Approvals** (according to type)



80.71



- Multi-voltage
- Multi-function

- AI:** On-delay  
**DI:** Interval  
**SW:** Symmetrical flasher (starting pulse on)  
**BE:** Off-delay with control signal  
**CE:** On- and off-delay with control signal  
**DE:** Interval with control signal on

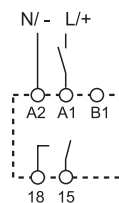

Wiring diagram  
(without control signal)

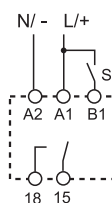

Wiring diagram  
(with control signal)

**Mono-function timer range****80.61 - Power off-delay (True off-delay), multi-voltage****80.82 - Star-delta, multi-voltage**

- 17.5 mm wide
- Rotary range selector, and timing trimmer
- Four time scales from 0.05s to 180 s (type 80.61)
- Six time scales from 0.1 s to 20min (type 80.82)
- High input/output isolation
- 35 mm rail (EN 60715) mount

80.61 / 80.82  
Screw terminal

FOR UL RATINGS SEE:

"General technical information" page V

For outline drawing see page 9

**Contact specification**

|   |           |             |                |
|---|-----------|-------------|----------------|
| Contact configuration                       |           | 1 CO (SPDT) | 2 NO (DPST-NO) |
| Rated current/Maximum peak current          | A         | 8/15        | 6/10           |
| Rated voltage/<br>Maximum switching voltage | V AC      | 250/400     | 250/400        |
| Rated load AC1                              | VA        | 2000        | 1500           |
| Rated load AC15 (230 V AC)                  | VA        | 400         | 300            |
| Single phase motor rating (230 V AC)        | kW        | 0.3         | —              |
| Breaking capacity DC1: 30/110/220 V         | A         | 8/0.3/0.12  | 6/0.2/0.12     |
| Minimum switching load                      | mW (V/mA) | 300 (5/5)   | 500 (12/10)    |
| Standard contact material                   |           | AgNi        | AgNi           |

**Supply specification**

|                                   |                 |             |             |
|-----------------------------------|-----------------|-------------|-------------|
| Nominal voltage (U <sub>N</sub> ) | V AC (50/60 Hz) | 24...240    | 24...240    |
|                                   | V DC            | 24...220    | 24...240    |
| Rated power AC/DC                 | VA (50 Hz)/W    | < 0.6/< 0.6 | < 1.3/< 0.8 |
| Operating range                   | V AC            | 16.8...265  | 16.8...265  |
|                                   | V DC            | 16.8...242  | 16.8...265  |

**Technical data**

|                                      |        |  |  |
|--------------------------------------|--------|--|--|
| Specified time range                 |        | (0.05...2)s, (1...16)s, (8...70)s, (50...180)s | (0.1...2)s, (1...20)s, (0.1...2)min, (1...20)min |
| Repeatability                        | %      | ± 1  | ± 1  |
| Recovery time                        | ms     | —  | 100  |
| Minimum control impulse              | ms     | 500 (A1-A2)                                    | —  |
| Setting accuracy-full range          | %      | ± 5  | ± 5  |
| Electrical life at rated load in AC1 | cycles | 100 · 10 <sup>3</sup>                          | 60 · 10 <sup>3</sup>                             |
| Ambient temperature range            | °C     | -20...+60                                      | -20...+60  |
| Protection category                  |        | IP 20  | IP 20  |

**Approvals** (according to type)**80.61**

- Multi-voltage
- Mono-function

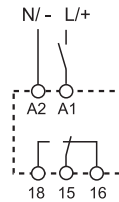
**BI:** Power off-delay (True off-delay)Wiring diagram  
(without control signal)**80.82**

- Multi-voltage
- Mono-function
- Transfer time can be regulated (0.05...1)s

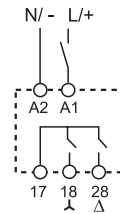
**SD:** Star-deltaWiring diagram  
(without control signal)

**Multi-function and multi-voltage**

- 17.5 mm wide
- Six time scales from 0.1 s to 24 h
- High input/output isolation
- 35 mm rail (EN 60715) mount
- "Blade + cross" - both flat blade and cross head screw drivers can be used to adjust the range and function selectors, the timing trimmer, and to disengage the rail mounting clip
- New multi-voltage versions with "PWM clever" technology

80.51.0.240.0000  
Screw terminal

80.51.0.240.P000  
Push-in terminal



FOR UL RATINGS SEE:

"General technical information" page V

For outline drawing see page 9

**Contact specification**

|   |           |
|---|-----------|
| Contact configuration                       |           |
| Rated current/Maximum peak current          | A         |
| Rated voltage/<br>Maximum switching voltage | V AC      |
| Rated load AC1                              | VA        |
| Rated load AC15 (230 V AC)                  | VA        |
| Single phase motor rating (230 V AC)        | kW        |
| Breaking capacity DC1: 30/110/220 V         | A         |
| Minimum switching load                      | mW (V/mA) |
| Standard contact material                   |           |

**Supply specification**

|                                   |                 |
|-----------------------------------|-----------------|
| Nominal voltage (U <sub>N</sub> ) | V AC (50/60 Hz) |
|                                   | V DC            |
| Rated power AC/DC                 | VA (50 Hz)/W    |
| Operating range                   | V AC            |
|                                   | V DC            |

**Technical data**

|                                      |        |
|--------------------------------------|--------|
| Specified time range                 |        |
| Repeatability                        | %      |
| Recovery time                        | ms     |
| Minimum control impulse              | ms     |
| Setting accuracy-full range          | %      |
| Electrical life at rated load in AC1 | cycles |
| Ambient temperature range            | °C     |
| Protection category                  |        |

**Approvals** (according to type)



- Multi-voltage (24...240) V AC/DC
- Multi-function

- AI:** On-delay
- DI:** Interval
- SW:** Symmetrical flasher (starting pulse on)
- BE:** Off-delay with control signal
- CE:** On- and off-delay with control signal
- DE:** Interval with control signal on

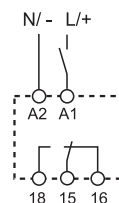

Wiring diagram  
(without control signal)

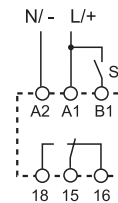

Wiring diagram  
(with control signal)

H

|   |   |
|---|---|
| Contact configuration                       | 1 CO (SPDT)   |
| Rated current/Maximum peak current          | 8/16  |
| Rated voltage/<br>Maximum switching voltage | 250/400   |
| Rated load AC1                              | 2000  |
| Rated load AC15 (230 V AC)                  | 400   |
| Single phase motor rating (230 V AC)        | 0.3   |
| Breaking capacity DC1: 30/110/220 V         | 8/0.3/0.12  |
| Minimum switching load                      | 500 (10/5)  |
| Standard contact material                   | AgNi  |
| Nominal voltage (U <sub>N</sub> )           | 24...240  |
|   | 24...240  |
| Rated power AC/DC                           | < 1.8/< 1   |
| Operating range                             | 17...265  |
|   | 17...265  |
| Specified time range                        | (0.1...2)s, (1...20)s, (0.1...2)min, (1...20)min, (0.1...2)h, (1...24)h |
| Repeatability                               | ± 1   |
| Recovery time                               | ≤ 50  |
| Minimum control impulse                     | 50  |
| Setting accuracy-full range                 | ± 5   |
| Electrical life at rated load in AC1        | 100 · 10 <sup>3</sup>   |
| Ambient temperature range                   | -20...+60   |
| Protection category                         | IP 20   |

## Ordering information

Example: 80 series, modular timers, 1 CO (SPDT) - 16 A, supply rated at (12...240)V AC/DC.

8 0 . 0 1 . 0 . 2 4 0 . 0 0 0 0

### Series

### Type

- 0 = Multi-function (AI, DI, SW, BE, CE, DE)
- 1 = On-delay (AI)
- 2 = Interval (DI)
- 4 = Off-delay with control signal (BE)
- 5 = Multi-function (AI, DI, SW, BE, CE, DE)
- 6 = Power off-delay (True off-delay) (BI)
- 7 = Multi-function with solid state output (AI, DI, SW, BE, CE, DE)
- 8 = Star-delta (SD)
- 9 = Asymmetrical flasher (LI, LE)

### Versions

- 0 = Standard
- P = Push-in (only for 80.51)

### Supply voltage

- 240 = (12...240)V AC/DC (80.01, 80.91)
- 240 = (24...240)V AC/DC (80.11, 80.21, 80.41, 80.51, 80.71, 80.82)
- 240 = (24...240)V AC, (24...220)V DC (80.61)

### Supply version

- 0 = AC (50/60 Hz)/DC

### No. of poles

- 1 = 1 CO (SPDT)
- 1 = 1 NO (SPST-NO), type 80.71 only
- 2 = 2 NO (DPST-NO), type 80.82 only

## Technical data

### Insulation

|   |                                  |      | 80.01/11/21/41/51/82/91 | 80.61 | 80.71 |
|---|----------------------------------|------|-------------------------|-------|-------|
| Dielectric strength                             | between input and output circuit | V AC | 4000                    | 2500  | 2500  |
|   | between open contacts            | V AC | 1000                    | 1000  | —     |
| Insulation (1.2/50 μs) between input and output |                                  | kV   | 6                       | 4     | 4     |

### EMC specifications

| Type of test  |                   | Reference standard | 80.01/11/21/41/61/71/91 | 80.51/82 |
|---|-------------------|--------------------|-------------------------|----------|
| Electrostatic discharge   | contact discharge | EN 61000-4-2       | 4 kV                    | 4 kV     |
|   | air discharge     | EN 61000-4-2       | 8 kV                    | 8 kV     |
| Radio-frequency electromagnetic field (80 ÷ 1000 MHz)           |                   | EN 61000-4-3       | 10 V/m                  | 10 V/m   |
| Fast transients (burst) (5-50 ns, 5 kHz) on Supply terminals    |                   | EN 61000-4-4       | 4 kV                    | 4 kV     |
| Surges (1.2/50 μs) on Supply terminals                          | common mode       | EN 61000-4-5       | 4 kV                    | 4 kV     |
|   | differential mode | EN 61000-4-5       | 4 kV                    | 4 kV     |
|   | common mode       | EN 61000-4-5       | 4 kV                    | 4 kV     |
|   | differential mode | EN 61000-4-5       | 4 kV                    | 4 kV     |
| Radio-frequency common mode (0.15 ÷ 80 MHz) on Supply terminals |                   | EN 61000-4-6       | 10 V                    | 10 V     |
| Radiated and conducted emission                                 |                   | EN 55022           | class B                 | class A  |

### Other data

|   |                         |   |        |
|---|-------------------------|---|--------|
| Current absorption on signal control (B1) |                         |   | < 1 mA |
| Power lost to the environment             | without contact current | W | 1.4    |
|   | with rated current      | W | 3.2    |

### Terminals

|   |                 |  | Screw terminals | Push-in terminals |
|---|-----------------|--|-----------------|-------------------|
| Wire strip length   | mm              |  | 10              | 10                |
|  Screw torque | Nm              |  | 0.8             | —                 |
| Min. wire size  |                 |  | solid cable     | solid cable       |
|   | mm <sup>2</sup> |  | 0.5             | 0.75              |
|   | AWG             |  | 20              | 18                |
| Max. wire size  |                 |  | solid cable     | solid cable       |
|   | mm <sup>2</sup> |  | 1 x 6 / 2 x 4   | 1 x 1.5 / 2 x 1.5 |
|   | AWG             |  | 1 x 10 / 2 x 12 | 1 x 16 / 2 x 16   |
| Min. wire size  |                 |  | stranded cable  | stranded cable    |
|   | mm <sup>2</sup> |  | 0.5             | 0.75              |
|   | AWG             |  | 20              | 18                |
| Max. wire size  |                 |  | stranded cable  | stranded cable    |
|   | mm <sup>2</sup> |  | 1 x 4 / 2 x 2.5 | 1 x 2.5 / 2 x 2.5 |
|   | AWG             |  | 1 x 12 / 2 x 14 | 1 x 14 / 2 x 14   |



Outline drawings

Types 80.01/80.51  
Screw terminal

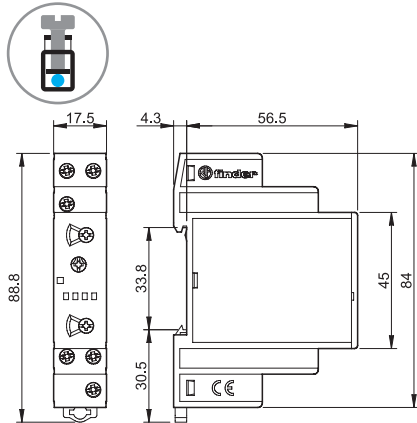

Type 80.51  
Push-in terminal

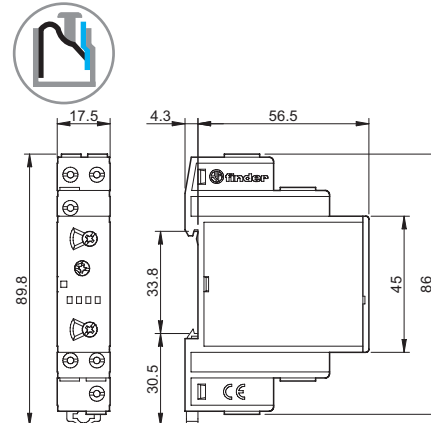

Types 80.11/80.21/80.61  
Screw terminal

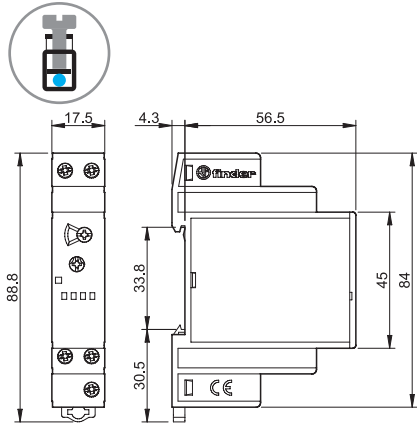

Type 80.41  
Screw terminal

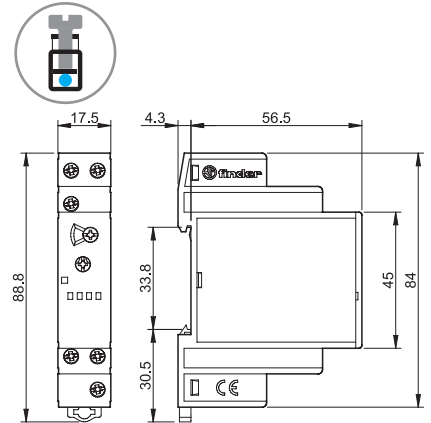

Type 80.91  
Screw terminal

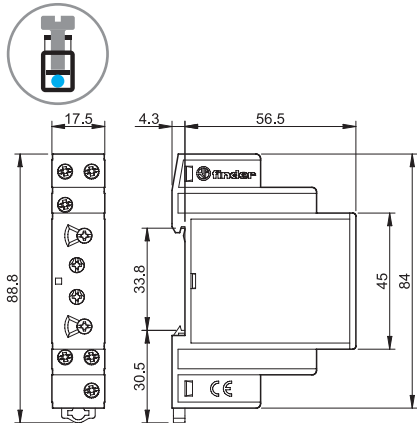

Type 80.71  
Screw terminal

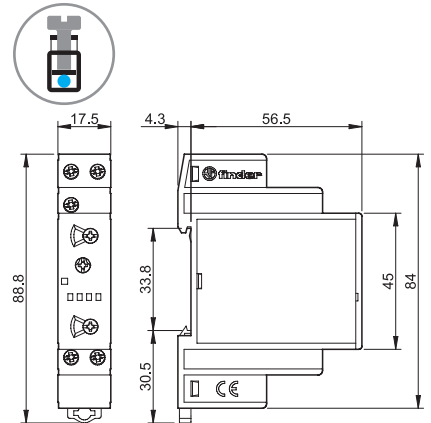

Type 80.82  
Screw terminal

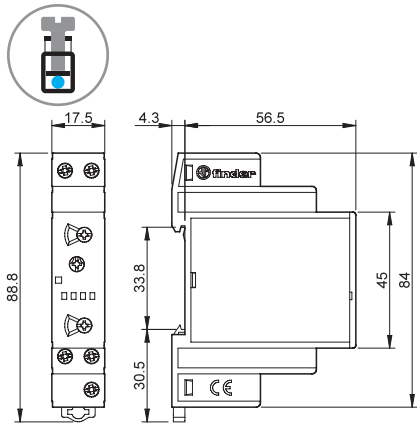

IX-2021, www.findernet.com

H

Functions

**U** = Supply voltage  
**S** = Signal switch  
— = Output contact

| LED* | Supply voltage | NO output contact            | Contacts |         |
|------|----------------|------------------------------|----------|---------|
|      |                |                              | Open     | Closed  |
|      | OFF            | Open                         | 15 - 18  | 15 - 16 |
|      | ON             | Open                         | 15 - 18  | 15 - 16 |
|      | ON             | Open<br>(Timing in Progress) | 15 - 18  | 15 - 16 |
|      | ON             | Closed                       | 15 - 16  | 15 - 18 |

\* The LED on type 80.61 is illuminated only when the supply voltage is applied to the timer; during the timing period the LED is not illuminated.

Without control signal = Start via contact in supply line (A1).  
With control signal = Start via contact into control terminal (B1).

Wiring diagram

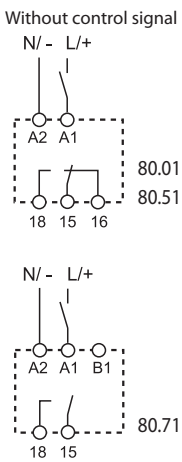

Type  
**80.01**  
**80.51**  
**80.71**

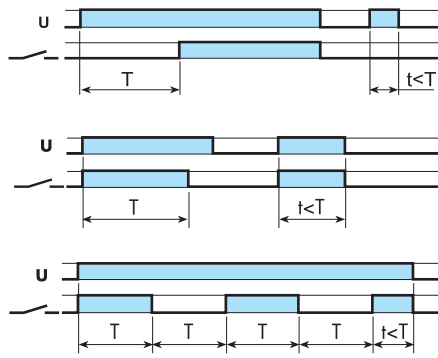

**(AI) On-delay.**  
Apply power to timer. Output contacts transfer after preset time has elapsed. Reset occurs when power is removed.

**(DI) Interval.**  
Apply power to timer. Output contacts transfer immediately. After the preset time has elapsed, contacts reset.

**(SW) Symmetrical flasher (starting pulse on).**  
Apply power to timer. Output contacts transfer immediately and cycle between ON and OFF for as long as power is applied. The ratio is 1:1 (time on = time off).

H

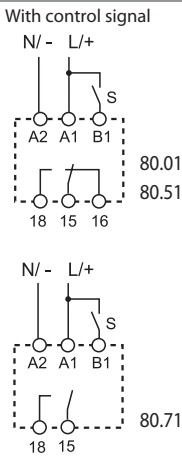

**80.01**  
**80.51**  
**80.71**

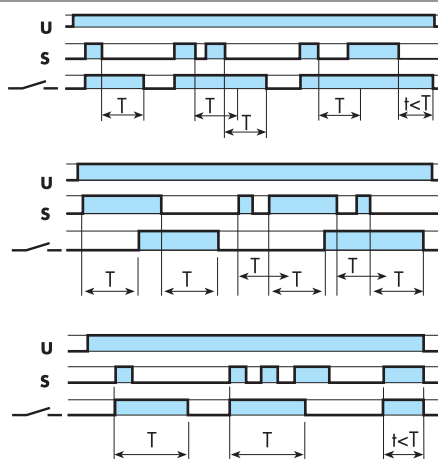

**(BE) Off-delay with control signal.**  
Power is permanently applied to the timer. The output contacts transfer immediately on closure of the Signal Switch (S). Opening the Signal Switch initiates the preset delay, after which time the output contacts reset.

**(CE) On- and off-delay with control signal.**  
Power is permanently applied to the timer. Closing the Signal Switch (S) initiates the preset delay, after which time the output contacts transfer. Opening the Signal switch initiates the same preset delay, after which time the output contacts reset.

**(DE) Interval with control signal on.**  
Power is permanently applied to the timer. On momentary or maintained closure of Signal Switch (S), the output contacts transfer, and remain so for the duration of the preset delay, after which they reset.

NOTE: The function must be set before energising the timer.

• Possible to control an external load, such as another relay coil or timer, connected to the control signal terminal B1.

\* With DC supply, positive polarity has to be connected to B1 terminal (according to EN 60204-1).

\*\* A voltage other than the supply voltage can be applied to the command Start (B1), example:  
A1 - A2 = 230 V AC  
B1 - A2 = 12 V DC

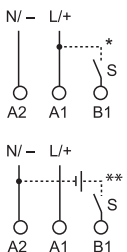
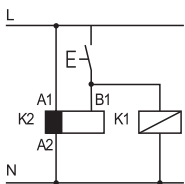

## Functions

### Wiring diagram

|  |  |  |  |
|--|--|--|--|
| <p>Without control signal</p> <p>80.11/21/61</p> <p>80.82</p>                      | <p><b>Type</b></p> <p><b>80.11</b></p> <p><b>80.21</b></p> <p><b>80.61</b></p> <p><b>80.82</b></p> |  | <p><b>(AI) On-delay.</b><br/>Apply power to timer. Output contacts transfer after preset time has elapsed. Reset occurs when power is removed.</p> <p><b>(DI) Interval.</b><br/>Apply power to timer. Output contacts transfer immediately. After the preset time has elapsed, contacts reset.</p> <p><b>(BI) Power off-delay (True off-delay).</b><br/>Apply power to timer (minimum 500 ms). Output contacts transfer immediately. Removal of power initiates the preset delay, after which time the output contacts reset.</p> <p><b>(SD) Star-delta.</b><br/>Apply power to timer. The star contact ( <math>\lambda</math> ) closes immediately. After preset delay has elapsed the star contact ( <math>\lambda</math> ) resets. After a further transfer time variable from (0.05...1)s the delta contact ( <math>\Delta</math> ) closes and remains in that position, until reset on power off.</p> |
| <p>With control signal</p> <p>80.41</p>  | <p><b>80.41</b></p>  |  | <p><b>(BE) Off-delay with control signal.</b><br/>Power is permanently applied to the timer. The output contacts transfer immediately on closure of the Signal Switch (S). Opening the Signal Switch initiates the preset delay, after which time the output contacts reset.</p>   |
| <p>Without control signal</p> <p>80.91</p> <p>With control signal</p> <p>80.91</p> | <p><b>80.91</b></p>  |  | <p><b>(LI) Asymmetrical flasher (starting pulse on).</b><br/>Apply power to timer. Output contacts transfer immediately and cycle between ON and OFF for as long as power is applied. The ON (T<sub>1</sub>) and OFF (T<sub>2</sub>) times are independently adjustable.</p> <p><b>(LE) Asymmetrical flasher (starting pulse on) with control signal</b><br/>Power is permanently applied to the timer. Closing Signal Switch (S) causes the output contacts to transfer immediately and cycle between ON (T<sub>1</sub>) and OFF (T<sub>2</sub>), until opened.</p>   |

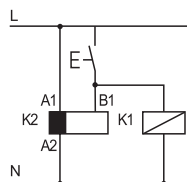

• Possible to control an external load, such as another relay coil or timer, connected to the control signal terminal B1.

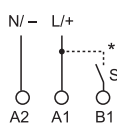

\* With DC supply, positive polarity has to be connected to B1 terminal (according to EN 60204-1).

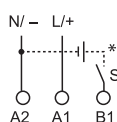

\*\* A voltage other than the supply voltage can be applied to the command Start (B1), example:

A1 - A2 = 230 V AC

B1 - A2 = 12 V DC

## Times scales

Rotary switch position series 80

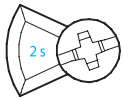

(0.1...2)s

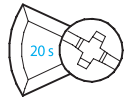

(1...20)s

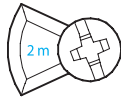

(0.1...2)min

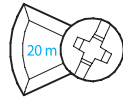

(1...20)min

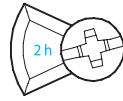

(0.1...2)h

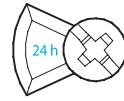

(1...24)h

## Accessories

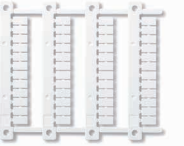

060.48

**Sheet of marker tags (CEMBRE Thermal transfer printers)** for relays types  
80.01/11/21/41/51/61/71 (48 tags), 6 x 12 mm

060.48