

LXA03D530

Qspeed™ Family

530 V, 3 A X-Series Diode

Product Summary

$I_{F(AVG)}$	3	A
V_{RRM}	530	V
Q_{RR} (Typ at 125 °C)	75	nC
I_{RRM} (Typ at 125 °C)	3.2	A
Softness t_B/t_A (Typ at 125 °C)	0.34	

Pin Assignment

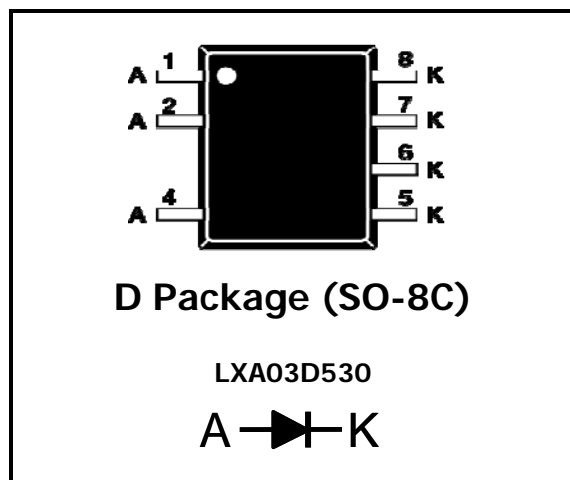

RoHS Compliant

Package uses lead-free plating and green mold compound.

Halogen-free per IEC 61249-2-21.

General Description

This device is an extremely low reverse recovery 530 V silicon diode. Its recovery characteristics increase efficiency, reduce EMI and eliminate snubbers.

Applications

- High-voltage power rectifier
- Power factor correction (PFC) boost diode
- Motor drive circuits
- DC-AC inverters

Features

- Low Q_{RR} , low I_{RRM} , low t_{RR}
- High di_F/dt capable
- Soft recovery

Benefits

- Reduces peak reverse voltage
- Increases efficiency
 - Eliminates need for snubber circuits
 - Reduces EMI filter component size & count
- Enables extremely fast switching

Absolute Maximum Ratings

Absolute maximum ratings are the values beyond which the device may be damaged or have its useful life impaired. Functional operation under these conditions is not implied.

Symbol	Parameter	Conditions	Rating	Units
V_{RRM}	Peak repetitive reverse voltage	$T_J = 25\text{ °C}$	530	V
$I_{F(AVG)}$	Average forward current	$T_J = 150\text{ °C}$, $T_L = 29\text{ °C}$	3	A
I_{FSM}	Non-repetitive peak surge current	60 Hz, ½ cycle, $T_C = 25\text{ °C}$	25	A
I_{FSM}	Non-repetitive peak surge current	½ cycle of $t = 28\text{ }\mu\text{s}$ Sinusoid, $T_C = 25\text{ °C}$	350	A
$T_{J(MAX)}$	Maximum junction temperature		150	°C
T_{STG}	Storage temperature		-55 to 150	°C
P_D	Power dissipation	$T_L = 25\text{ °C}$	4.6	W

Thermal Resistance

Symbol	Resistance	Conditions	Rating	Units
$R_{\theta JA}$	Junction to ambient	Soldered to 1 sq. in. (645 mm ²), 2 oz. Cu.	80	°C/W
$R_{\theta JL}$	Junction to lead	Lead temperature measured on pin 7	27	°C/W

Electrical Specifications at $T_J = 25\text{ °C}$ (unless otherwise specified)

Symbol	Parameter	Conditions	Min	Typ	Max	Units	
DC Characteristics							
I_R	Reverse current	$V_R = 530\text{ V}, T_J = 25\text{ °C}$	-	0.4	250	μA	
		$V_R = 530\text{ V}, T_J = 125\text{ °C}$	-	0.275	-	mA	
V_F	Forward voltage	$I_F = 3\text{ A}, T_J = 25\text{ °C}$	-	1.55	1.71	V	
		$I_F = 3\text{ A}, T_J = 150\text{ °C}$	-	1.33	-	V	
C_J	Junction capacitance	$V_R = 10\text{ V}, 1\text{ MHz}$	-	15	-	pF	
Dynamic Characteristics							
t_{RR}	Reverse recovery time	$di/dt = 200\text{ A}/\mu\text{s}$ $V_R = 400\text{ V}, I_F = 3\text{ A}$	$T_J = 25\text{ °C}$	-	25	34.3	ns
			$T_J = 125\text{ °C}$	-	33	-	ns
Q_{RR}	Reverse recovery charge	$di/dt = 200\text{ A}/\mu\text{s}$ $V_R = 400\text{ V}, I_F = 3\text{ A}$	$T_J = 25\text{ °C}$	-	39	55	nC
			$T_J = 125\text{ °C}$	-	75	-	nC
I_{RRM}	Maximum reverse recovery current	$di/dt = 200\text{ A}/\mu\text{s}$ $V_R = 400\text{ V}, I_F = 3\text{ A}$	$T_J = 25\text{ °C}$	-	2.2	-	A
			$T_J = 125\text{ °C}$	-	3.2	-	A
S	Softness factor = $\frac{t_B}{t_A}$	$di/dt = 200\text{ A}/\mu\text{s}$ $V_R = 400\text{ V}, I_F = 3\text{ A}$	$T_J = 25\text{ °C}$	-	0.7	-	
			$T_J = 125\text{ °C}$	-	0.34	-	

Note to component engineers: X-Series diodes employ Schottky technologies in their design and construction. Therefore, component engineers should plan their test setups to be similar to those for traditional Schottky test set-ups. (For additional details, see Application Note AN-300.)

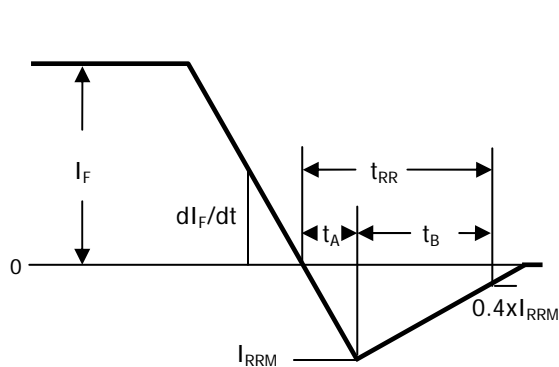

Figure 1. Reverse Recovery Definitions.

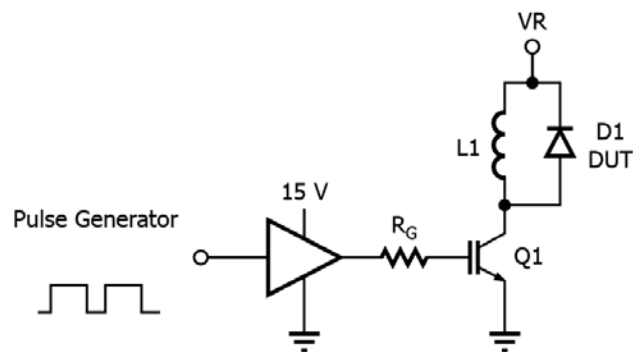

Figure 2. Reverse Recovery Test Circuit.

PI-7614-041315

Electrical Specifications at $T_J = 25\text{ }^\circ\text{C}$ (unless otherwise specified)

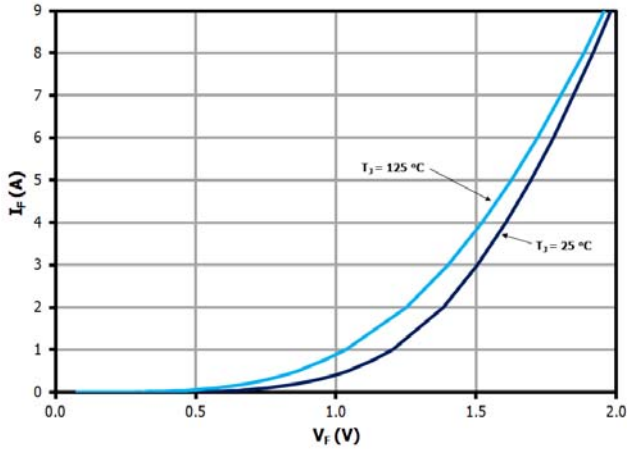

Figure 3. Typical I_F vs. V_F .

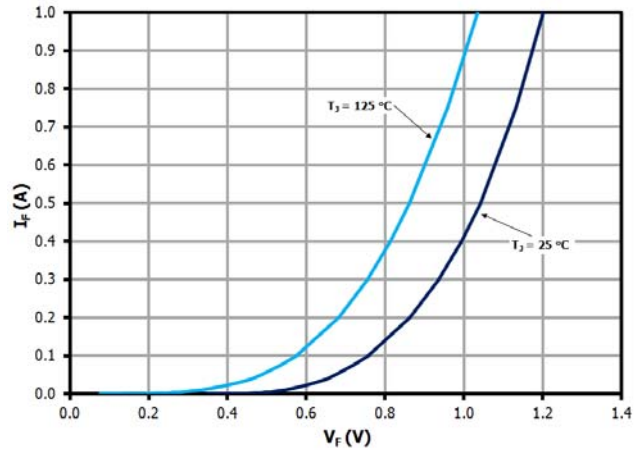

Figure 4. Typical I_F vs. V_F .

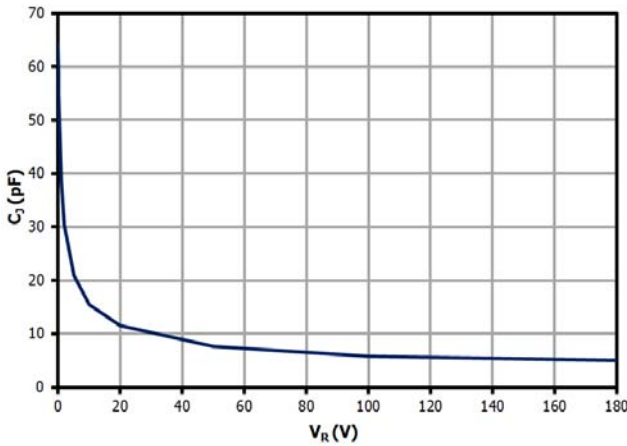

Figure 5. Typical C_J vs. V_R .

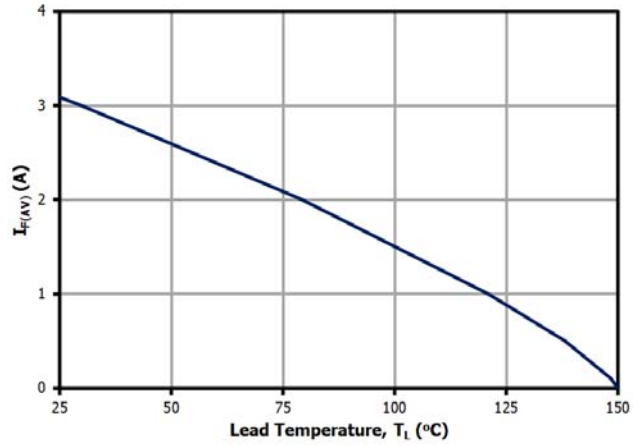

Figure 6. DC Current Derating Curve.

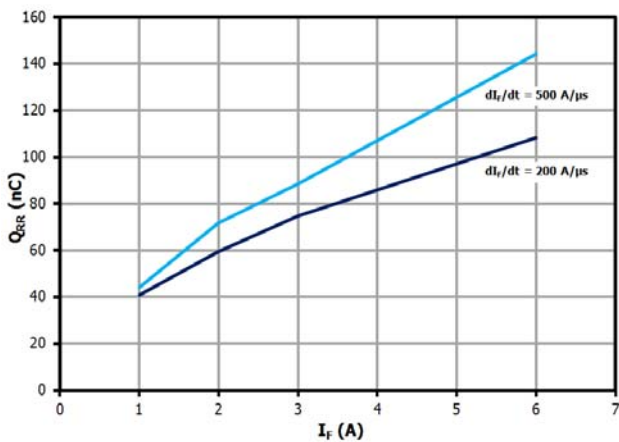

Figure 7. Typical Q_{RR} vs. I_F at $T_J = 125\text{ }^\circ\text{C}$.

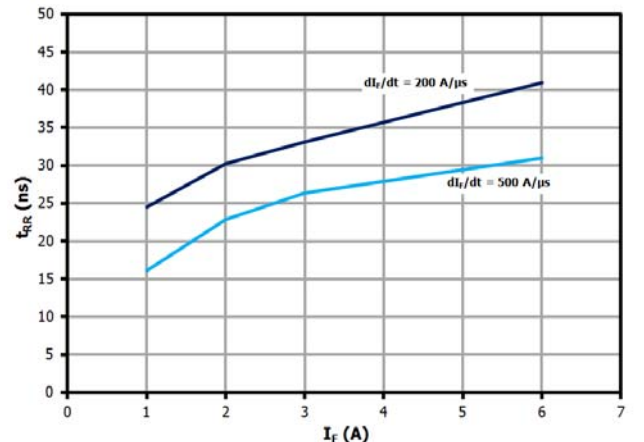

Figure 8. Typical t_{RR} vs. I_F at $T_J = 125\text{ }^\circ\text{C}$.

Electrical Specifications at $T_J = 25\text{ }^\circ\text{C}$ (unless otherwise specified)

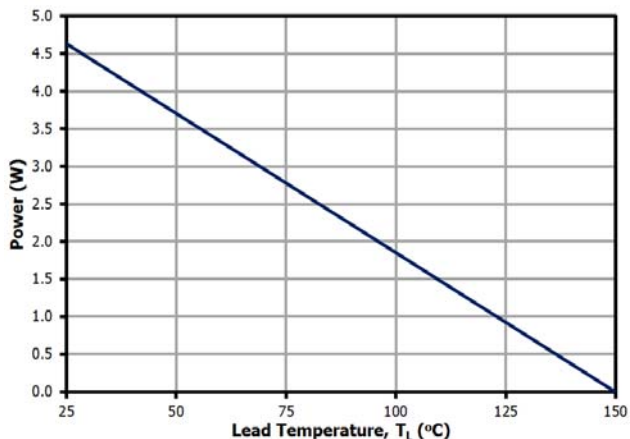

Figure 9. Power Derating Curve.

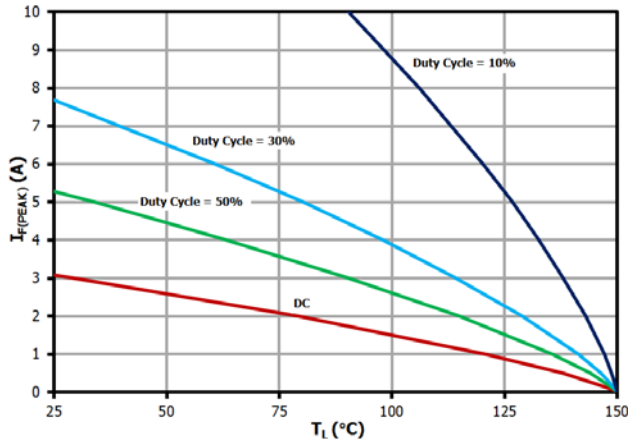

Figure 10. I_F (Peak) vs. T_L , $f = 70\text{ kHz}$.

LXA03D530

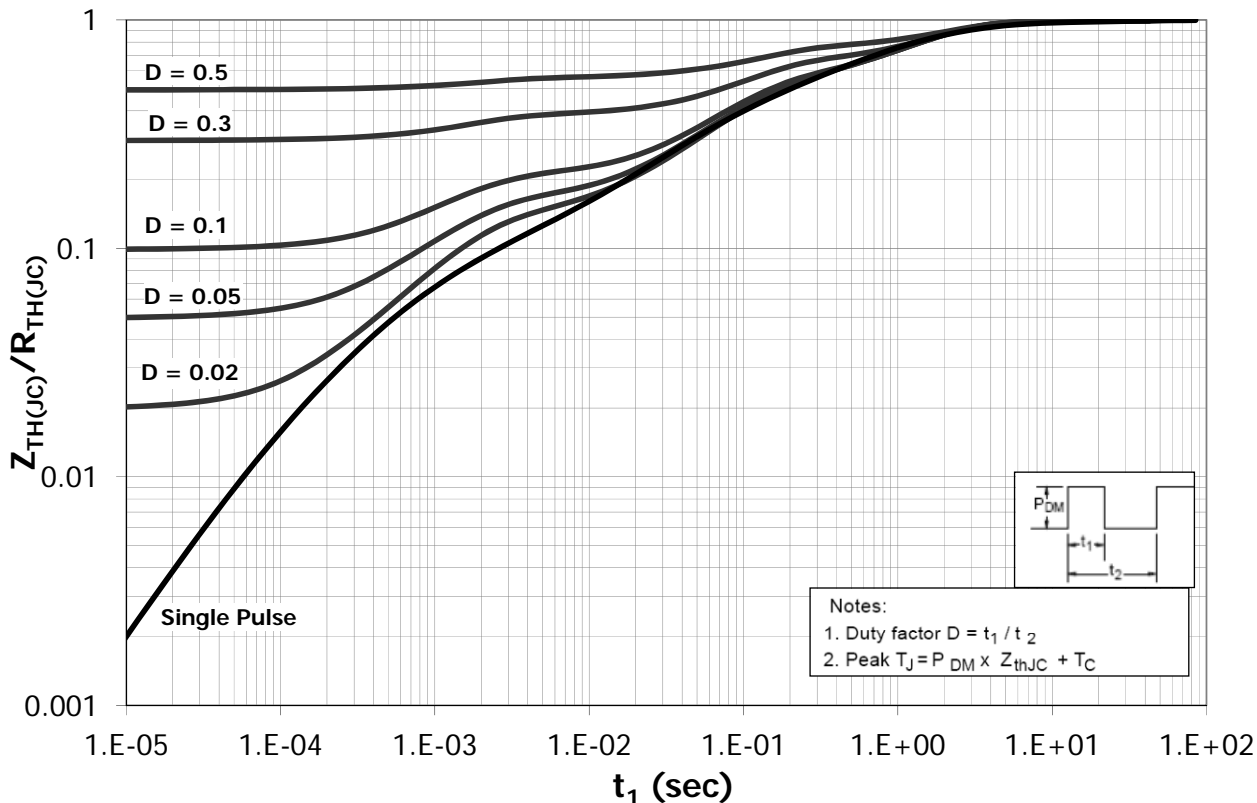
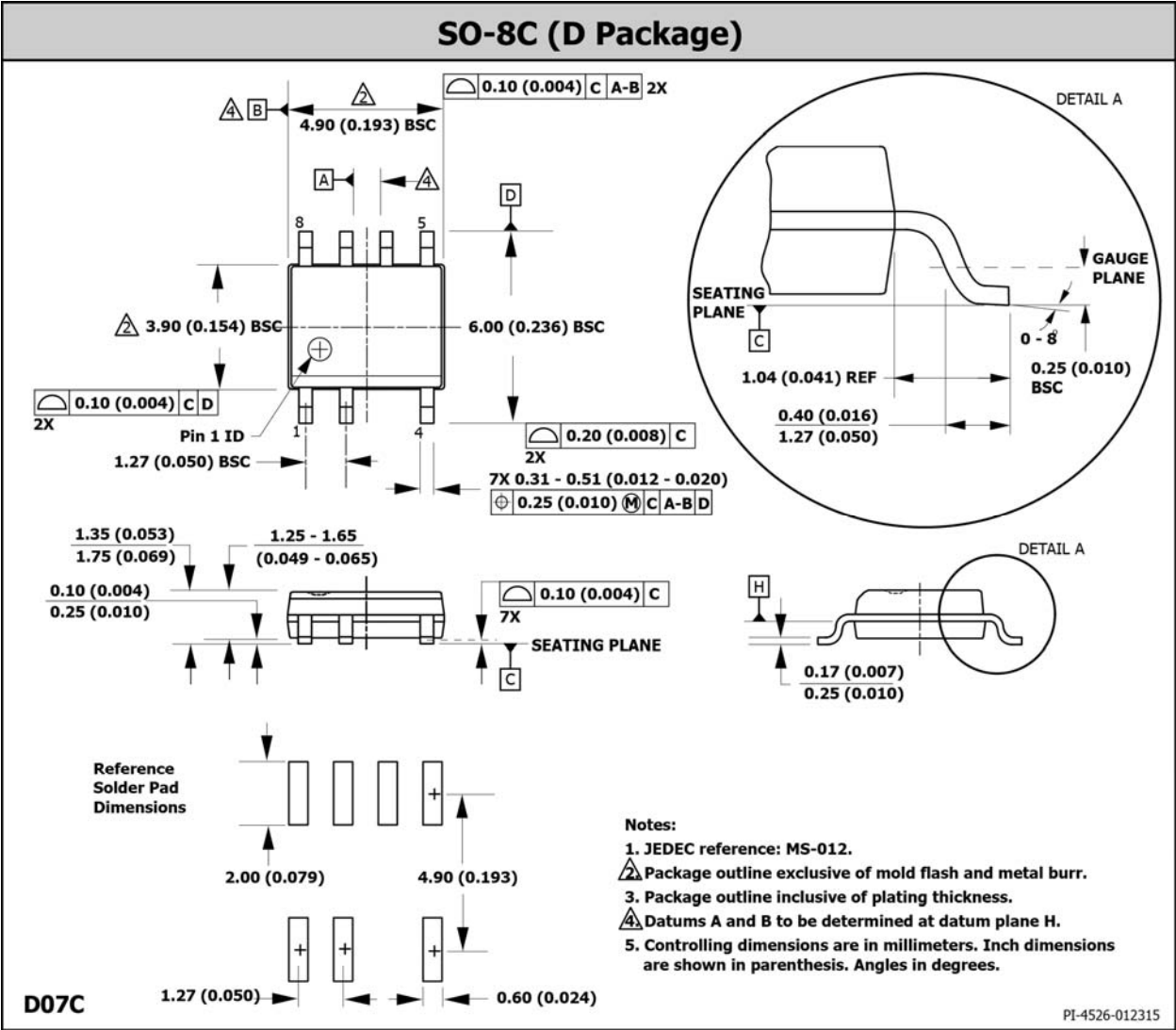

Figure 11. Normalized Maximum Transient Thermal Impedance.



Ordering Information

Part Number	Package	Packing
LXA03D530	SO-8C	2500 units/reel

The information contained in this document is subject to change without notice.

Revision	Notes	Date
1.0	Initial Release.	04/15

For the latest updates, visit our website: www.power.com

Power Integrations reserves the right to make changes to its products at any time to improve reliability or manufacturability. Power Integrations does not assume any liability arising from the use of any device or circuit described herein. POWER INTEGRATIONS MAKES NO WARRANTY HEREIN AND SPECIFICALLY DISCLAIMS ALL WARRANTIES INCLUDING, WITHOUT LIMITATION, THE IMPLIED WARRANTIES OF MERCHANTABILITY, FITNESS FOR A PARTICULAR PURPOSE, AND NON-INFRINGEMENT OF THIRD PARTY RIGHTS.

Patent Information

The products and applications illustrated herein (including transformer construction and circuits' external to the products) may be covered by one or more U.S. and foreign patents, or potentially by pending U.S. and foreign patent applications assigned to Power Integrations. A complete list of Power Integrations' patents may be found at www.power.com. Power Integrations grants its customers a license under certain patent rights as set forth at <http://www.power.com/ip.htm>.

Life Support Policy

POWER INTEGRATIONS PRODUCTS ARE NOT AUTHORIZED FOR USE AS CRITICAL COMPONENTS IN LIFE SUPPORT DEVICES OR SYSTEMS WITHOUT THE EXPRESS WRITTEN APPROVAL OF THE PRESIDENT OF POWER INTEGRATIONS. As used herein:

1. A Life support device or system is one which, (i) is intended for surgical implant into the body, or (ii) supports or sustains life, and (iii) whose failure to perform, when properly used in accordance with instructions for use, can be reasonably expected to result in significant injury or death to the user.
2. A critical component is any component of a life support device or system whose failure to perform can be reasonably expected to cause the failure of the life support device or system, or to affect its safety or effectiveness.

The PI Logo, TOPSwitch, TinySwitch, LinkSwitch, LYTSwitch, InnoSwitch, DPA-Switch, PeakSwitch, CAPZero, SENZero, LinkZero, HiperPFS, HiperTFS, HiperLCS, Ospeed, EcoSmart, Clampless, E-Shield, Filterfuse, FluxLink, StackFET, PI Expert and PI FACTS are trademarks of Power Integrations, Inc. Other trademarks are property of their respective companies. ©Copyright 2015 Power Integrations, Inc.

Power Integrations Worldwide Sales Support Locations

WORLD HEADQUARTERS

5245 Hellyer Avenue
San Jose, CA 95138, USA.
Main: +1-408-414-9200
Customer Service:
Phone: +1-408-414-9665
Fax: +1-408-414-9765
e-mail: usasales@power.com

GERMANY

Lindwurmstrasse 114
80337, Munich
Germany
Phone: +49-895-527-39110
Fax: +49-895-527-39200
e-mail: eurosales@power.com

JAPAN

Kosei Dai-3 Building
2-12-11, Shin-Yokohama,
Kohoku-ku, Yokohama-shi,
Kanagawa 222-0033
Japan
Phone: +81-45-471-1021
Fax: +81-45-471-3717
e-mail: japansales@power.com

TAIWAN

5F, No. 318, Nei Hu Rd.,
Sec. 1
Nei Hu District
Taipei 11493, Taiwan R.O.C.
Phone: +886-2-2659-4570
Fax: +886-2-2659-4550
e-mail: taiwansales@power.com

CHINA (SHANGHAI)

Rm 2410, Charity Plaza, No. 88,
North Caoyi Road,
Shanghai, PRC 200030
Phone: +86-21-6354-6323
Fax: +86-21-6354-6325
e-mail: chinasales@power.com

INDIA

#1, 14th Main Road
Vasanthanagar
Bangalore-560052
India
Phone: +91-80-4113-8020
Fax: +91-80-4113-8023
e-mail: indiasales@power.com

KOREA

RM 602, 6FL
Korea City Air Terminal B/D,
159-6
Samsung-Dong, Kangnam-Gu,
Seoul, 135-728 Korea
Phone: +82-2-2016-6610
Fax: +82-2-2016-6630
e-mail: koreasales@power.com

UK

First Floor, Unit 15, Meadway
Court, Rutherford Close,
Stevenage, Herts. SG1 2EF
United Kingdom
Phone: +44 (0) 1252-730-141
Fax: +44 (0) 1252-727-689
e-mail: eurosales@power.com

CHINA (SHENZHEN)

17/F, Hivac Building, No. 2, Keji
Nan 8th Road, Nanshan District,
Shenzhen, China, 518057
Phone: +86-755-8672-8689
Fax: +86-755-8672-8690
e-mail: chinasales@power.com

ITALY

Via Milanese 20, 3rd Fl.
20099 Sesto San Giovanni
(MI) Italy
Phone: +39-024-550-8701
Fax: +39-028-928-6009
e-mail: eurosales@power.com

SINGAPORE

51 Newton Road,
#19-01/05 Goldhill Plaza
Singapore, 308900
Phone: +65-6358-2160
Fax: +65-6358-2015
e-mail: singaporesales@power.com