

## OptiMOS<sup>®</sup>-P Small-Signal-Transistor Feature

- P-Channel
- Enhancement mode
- Logic Level
- 150°C operating temperature
- Avalanche rated
- dv/dt rated
- Pb-free lead plating; RoHS compliant
- Qualified according to AEC Q101
- Halogen free according to IEC61249-2-21



Halogen-Free

## Product Summary

$V_{DS}$	-30	V
$R_{DS(on)}$	43	m $\Omega$
$I_D$	-5.5	A

PG-TSOP-6-1

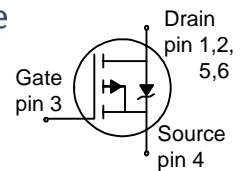
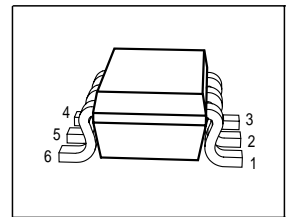

Type	Package	Tape and reel	Marking
BSL307SP	PG-TSOP-6-1	H6327: 3000pcs/r.	sPC

## Maximum Ratings, at $T_j = 25^\circ\text{C}$ , unless otherwise specified

Parameter	Symbol	Value	Unit
Continuous drain current	$I_D$		A
$T_A=25^\circ\text{C}$		-5.5	
$T_A=70^\circ\text{C}$		-4.4	
Pulsed drain current	$I_D \text{ puls}$	-22	
$T_A=25^\circ\text{C}$			
Avalanche energy, single pulse	$E_{AS}$	44	mJ
$I_D=-5.5 \text{ A}$ , $V_{DD}=-25\text{V}$ , $R_{GS}=25\Omega$			
Reverse diode dv/dt	dv/dt	-6	kV/ $\mu\text{s}$
$I_S=-5.5\text{A}$ , $V_{DS}=24\text{V}$ , $dI/dt=200\text{A}/\mu\text{s}$ , $T_{jmax}=150^\circ\text{C}$			
Gate source voltage	$V_{GS}$	$\pm 20$	V
Power dissipation	$P_{tot}$	2	W
$T_A=25^\circ\text{C}$			
Operating and storage temperature	$T_j, T_{stg}$	-55... +150	$^\circ\text{C}$
IEC climatic category; DIN IEC 68-1		55/150/56	
ESD Class JEDEC22-A114-HBM		Class 1a	

**Thermal Characteristics**

Parameter	Symbol	Values			Unit
		min.	typ.	max.	
<b>Characteristics</b>					
Thermal resistance, junction - soldering point	$R_{thJS}$	-	-	50	K/W
SMD version, device on PCB:	$R_{thJA}$				
@ min. footprint		-	-	230	
@ 6 cm <sup>2</sup> cooling area <sup>1)</sup>		-	-	62.5	

**Electrical Characteristics, at  $T_j = 25\text{ °C}$ , unless otherwise specified**

Parameter	Symbol	Values			Unit
		min.	typ.	max.	
<b>Static Characteristics</b>					
Drain-source breakdown voltage $V_{GS}=0, I_D=-250\mu A$	$V_{(BR)DSS}$	-30	-	-	V
Gate threshold voltage, $V_{GS} = V_{DS}$ $I_D=-40\mu A$	$V_{GS(th)}$	-1	-1.5	-2	
Zero gate voltage drain current $V_{DS}=-30V, V_{GS}=0, T_j=25\text{ °C}$ $V_{DS}=-30V, V_{GS}=0, T_j=150\text{ °C}$	$I_{DSS}$	-	-0.1	-1	$\mu A$
Gate-source leakage current $V_{GS}=-20V, V_{DS}=0$	$I_{GSS}$	-	-10	-100	
Drain-source on-state resistance $V_{GS}=-4.5V, I_D=-4.2A$	$R_{DS(on)}$	-	52	74	m $\Omega$
Drain-source on-state resistance $V_{GS}=-10V, I_D=-5.5A$	$R_{DS(on)}$	-	31	43	

<sup>1)</sup> Device on 40mm\*40mm\*1.5mm epoxy PCB FR4 with 6cm<sup>2</sup> (one layer, 70  $\mu m$  thick) copper area for drain connection. PCB is vertical without blown air;  $t \leq 5$  sec.

**Electrical Characteristics**, at  $T_j = 25\text{ }^\circ\text{C}$ , unless otherwise specified

Parameter	Symbol	Conditions	Values			Unit
			min.	typ.	max.	

**Dynamic Characteristics**

Transconductance	$g_{fs}$	$ V_{DS}  \geq 2 *  I_D  * R_{DS(on)max}$ $I_D = -4.4\text{A}$	4.7	9.4	-	S
Input capacitance	$C_{iss}$	$V_{GS} = 0, V_{DS} = -25\text{V},$ $f = 1\text{MHz}$	-	805	-	pF
Output capacitance	$C_{oss}$		-	234	-	
Reverse transfer capacitance	$C_{rss}$		-	195	-	
Turn-on delay time	$t_{d(on)}$	$V_{DD} = -15\text{V}, V_{GS} = -10\text{V},$ $I_D = -1\text{A}, R_G = 6\Omega$	-	7.3	11	ns
Rise time	$t_r$		-	8.4	12.6	
Turn-off delay time	$t_{d(off)}$		-	36.4	55	
Fall time	$t_f$		-	29	44	

**Gate Charge Characteristics**

Gate to source charge	$Q_{gs}$	$V_{DD} = -24\text{V}, I_D = -5.5\text{A}$	-	-2	-2.5	nC
Gate to drain charge	$Q_{gd}$		-	-8.2	-12.3	
Gate charge total	$Q_g$	$V_{DD} = -24\text{V}, I_D = -5.5\text{A},$ $V_{GS} = 0 \text{ to } -10\text{V}$	-	-23.4	-29	
Gate plateau voltage	$V_{(plateau)}$	$V_{DD} = -24\text{V}, I_D = -5.5\text{A}$	-	-2.8	-	V

**Reverse Diode**

Inverse diode continuous forward current	$I_S$	$T_A = 25^\circ\text{C}$	-	-	-5.5	A
Inverse diode direct current, pulsed	$I_{SM}$		-	-	-22	
Inverse diode forward voltage	$V_{SD}$	$V_{GS} = 0,  I_F  =  I_D $	-	-0.88	-1.3	V
Reverse recovery time	$t_{rr}$	$V_R = -15\text{V},  I_F  =  I_D ,$ $di_F/dt = 100\text{A}/\mu\text{s}$	-	16.6	21	ns
Reverse recovery charge	$Q_{rr}$		-	6.2	7.8	nC

### 1 Power dissipation

$$P_{tot} = f(T_A)$$

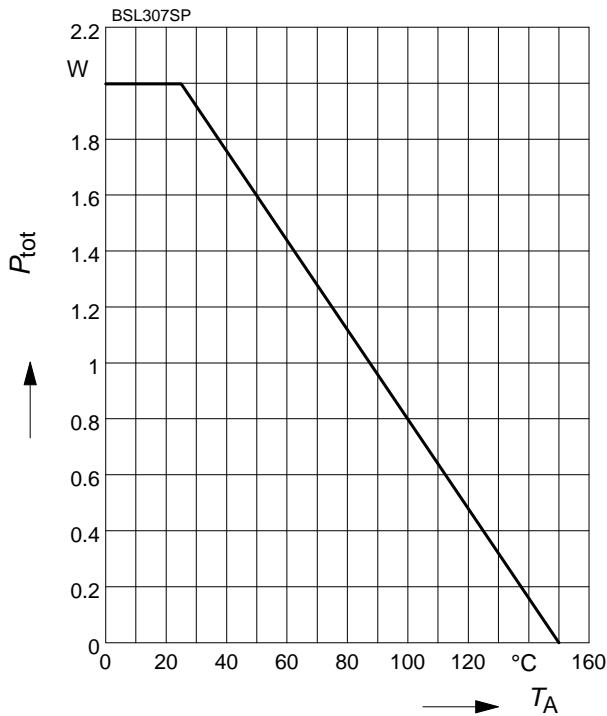

### 2 Drain current

$$I_D = f(T_A)$$

parameter:  $|V_{GS}| \geq 10 \text{ V}$

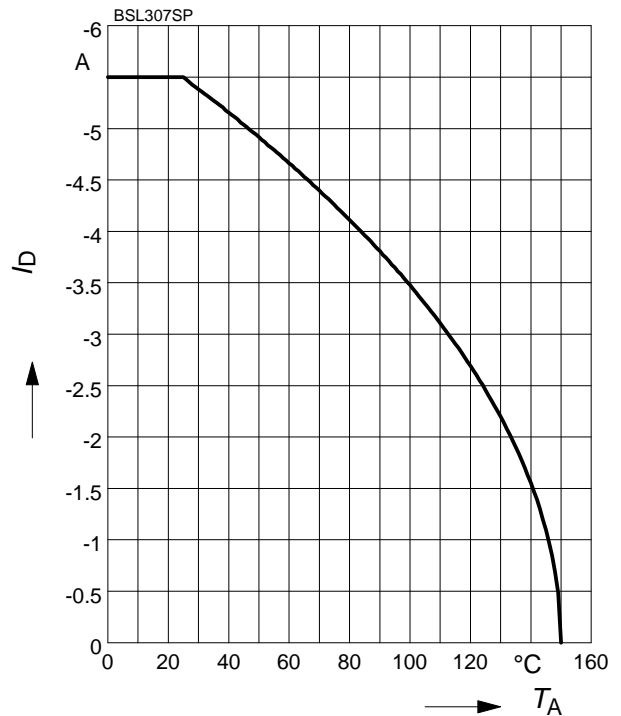

### 3 Safe operating area

$$I_D = f(V_{DS})$$

parameter:  $D = 0, T_A = 25 \text{ °C}$

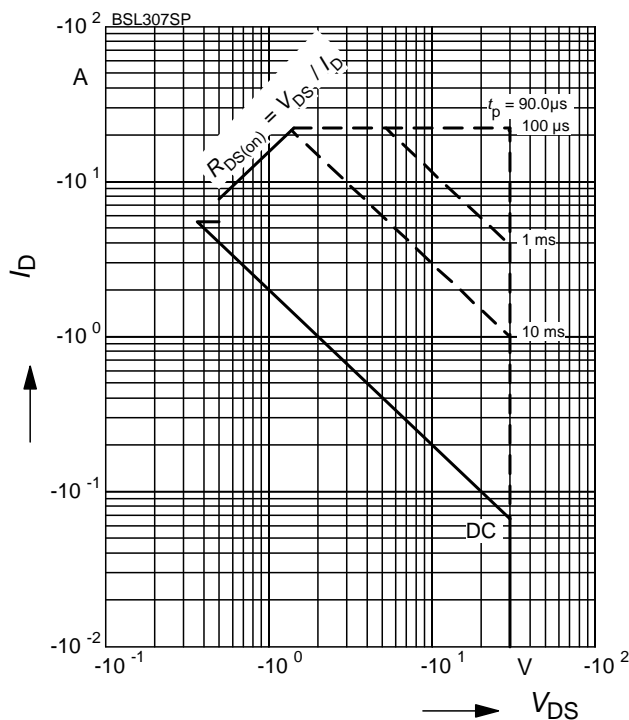

### 4 Transient thermal impedance

$$Z_{thJS} = f(t_p)$$

parameter:  $D = t_p/T$

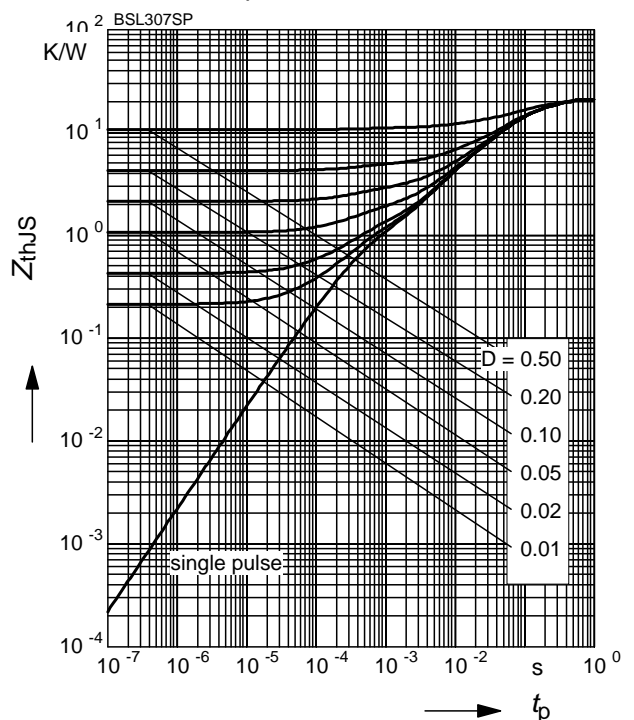

**5 Typ. output characteristic**

$I_D = f(V_{DS}); T_j = 25^\circ\text{C}$

parameter:  $t_p = 80 \mu\text{s}$

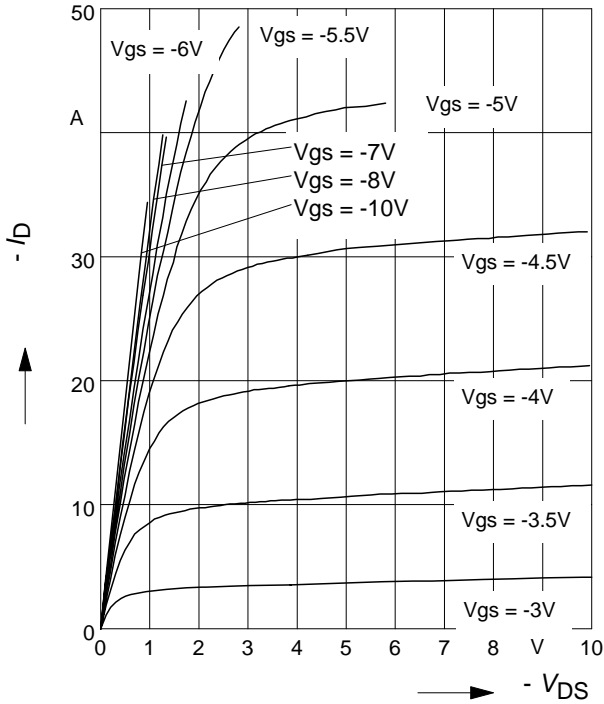

**6 Typ. drain-source on resistance**

$R_{DS(on)} = f(I_D)$

parameter:  $V_{GS}$

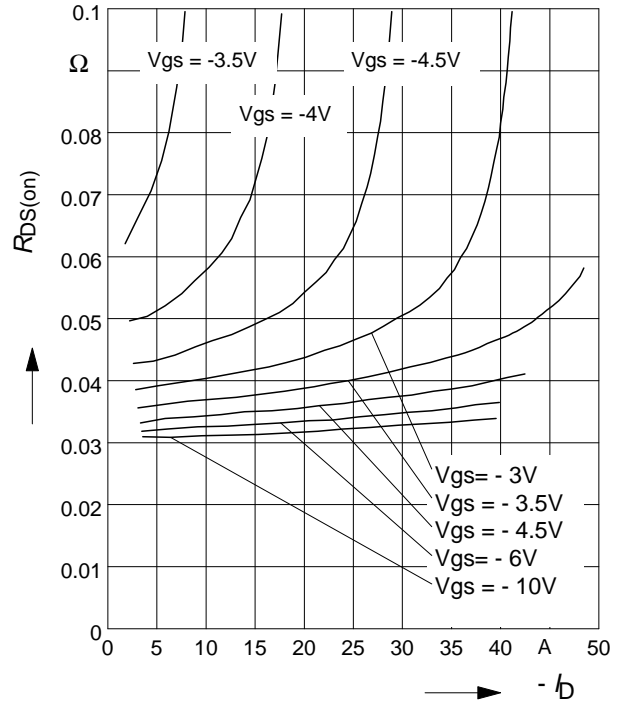

**7 Typ. transfer characteristics**

$I_D = f(V_{GS}); |V_{DS}| \geq 2 \times |I_D| \times R_{DS(on)max}$

parameter:  $t_p = 80 \mu\text{s}$

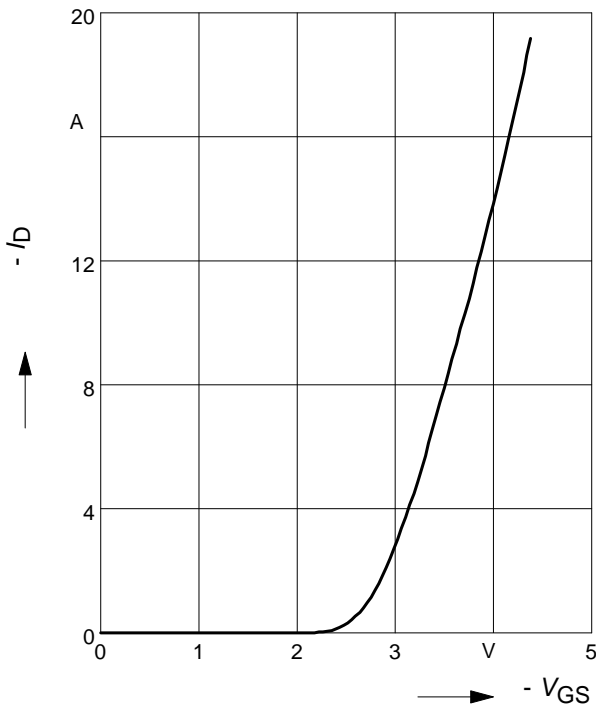

**8 Typ. forward transconductance**

$g_{fs} = f(I_D); T_j = 25^\circ\text{C}$

parameter:  $t_p = 80 \mu\text{s}$

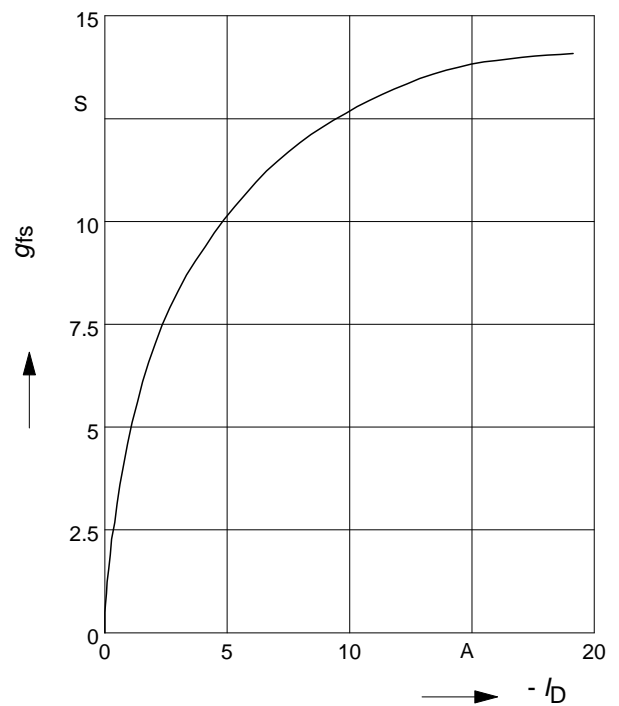

**9 Drain-source on-resistance**

$$R_{DS(on)} = f(T_j)$$

parameter:  $I_D = -5.5 \text{ A}$ ,  $V_{GS} = -10 \text{ V}$

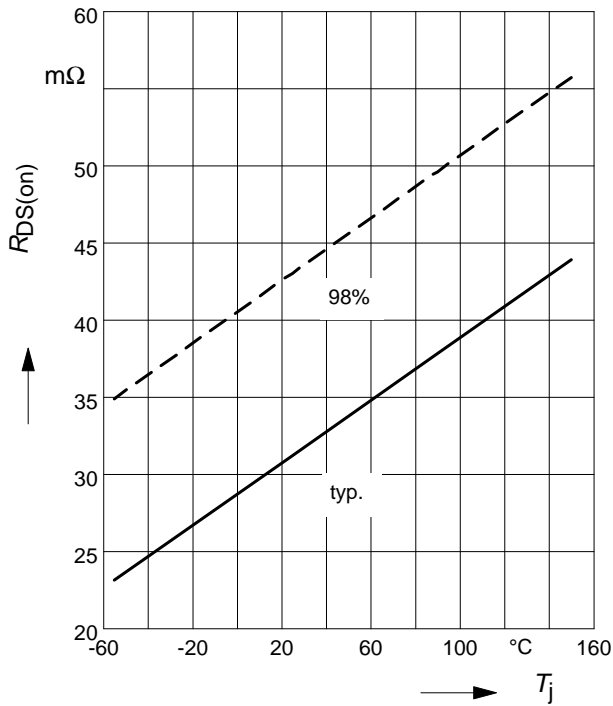

**10 Typ. gate threshold voltage**

$$V_{GS(th)} = f(T_j)$$

parameter:  $V_{GS} = V_{DS}$

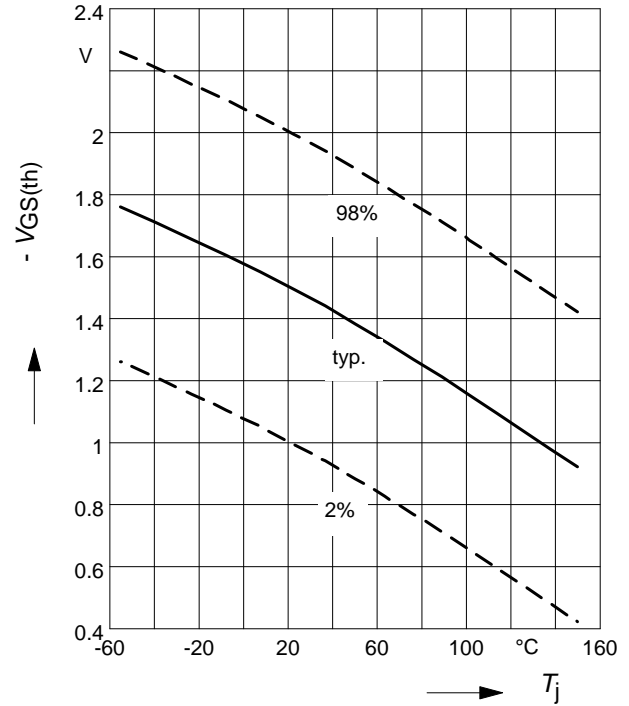

**11 Typ. capacitances**

$$C = f(V_{DS})$$

parameter:  $V_{GS}=0$ ,  $f=1 \text{ MHz}$

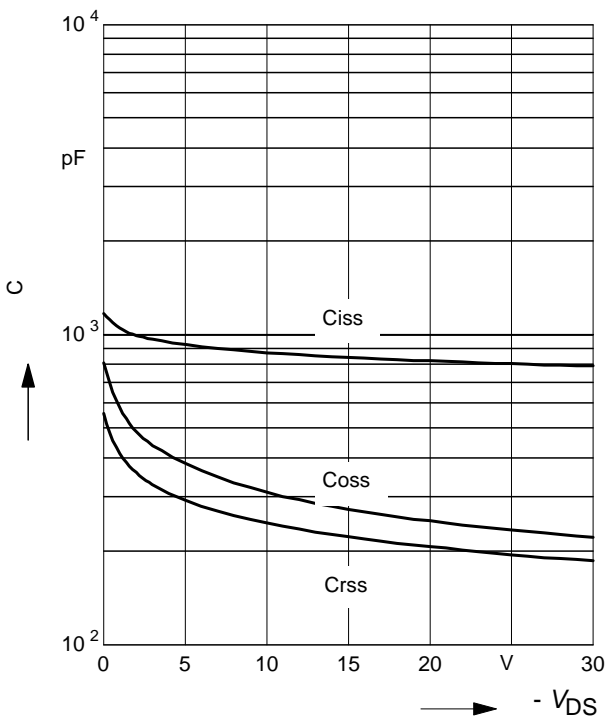

**12 Forward character. of reverse diode**

$$I_F = f(V_{SD})$$

parameter:  $T_j$ ,  $t_p = 80 \mu\text{s}$

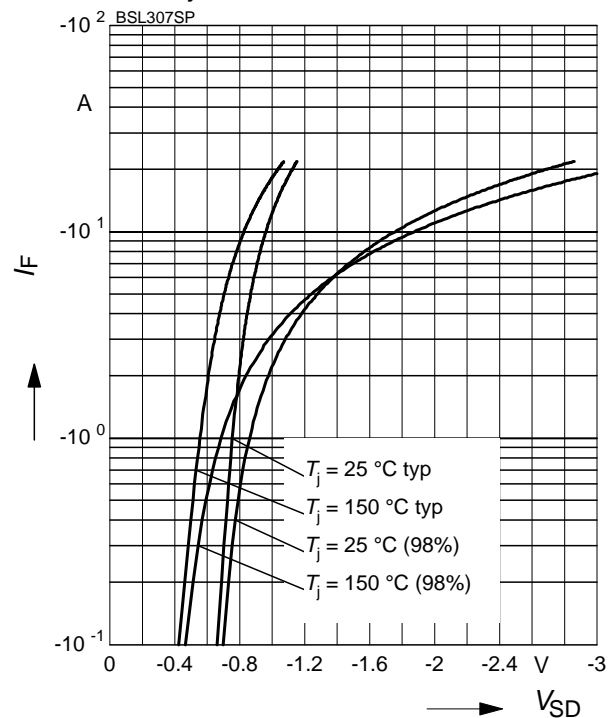

**13 Typ. avalanche energy**

$E_{AS} = f(T_j)$ , par.:  $I_D = -5.5 \text{ A}$

$V_{DD} = -25 \text{ V}$ ,  $R_{GS} = 25 \Omega$

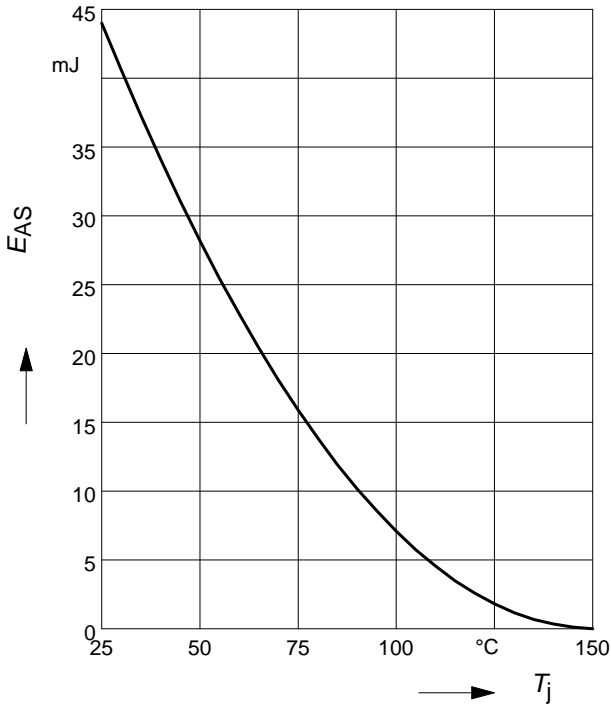

**14 Typ. gate charge**

$|V_{GS}| = f(Q_{Gate})$

parameter:  $I_D = -5.5 \text{ A}$  pulsed

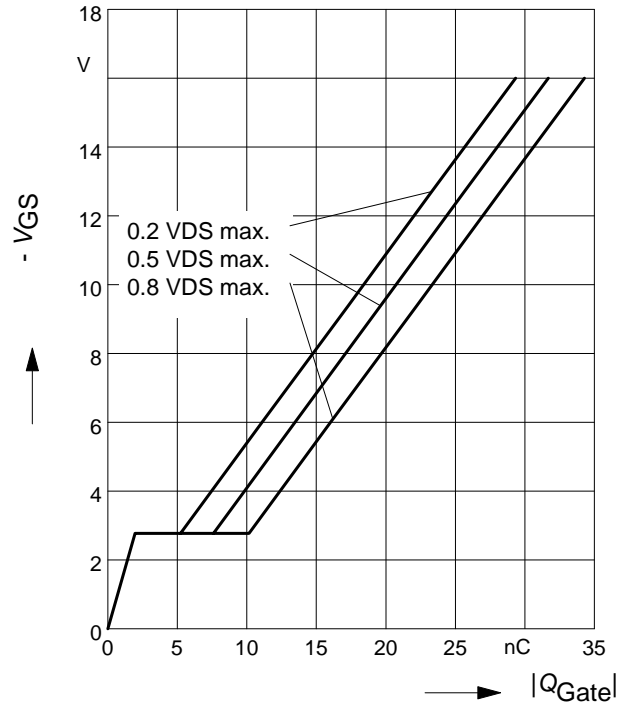

**15 Drain-source breakdown voltage**

$V_{(BR)DSS} = f(T_j)$

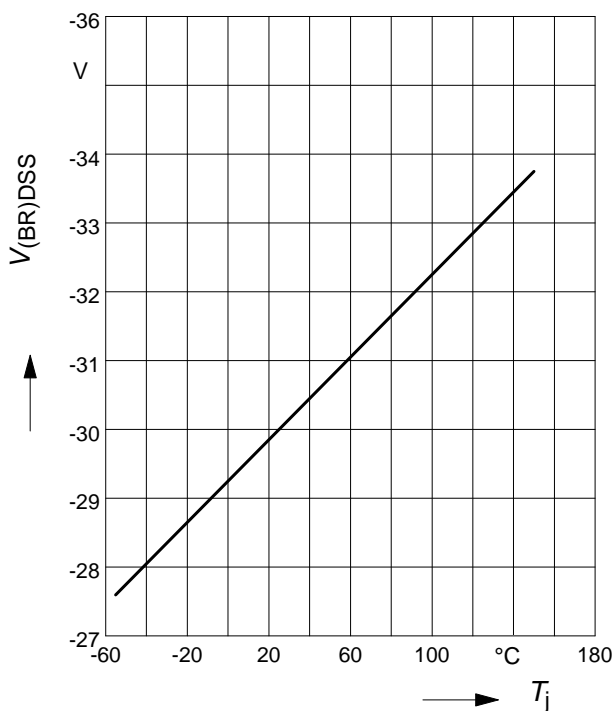

Package Outline:

TSOP6

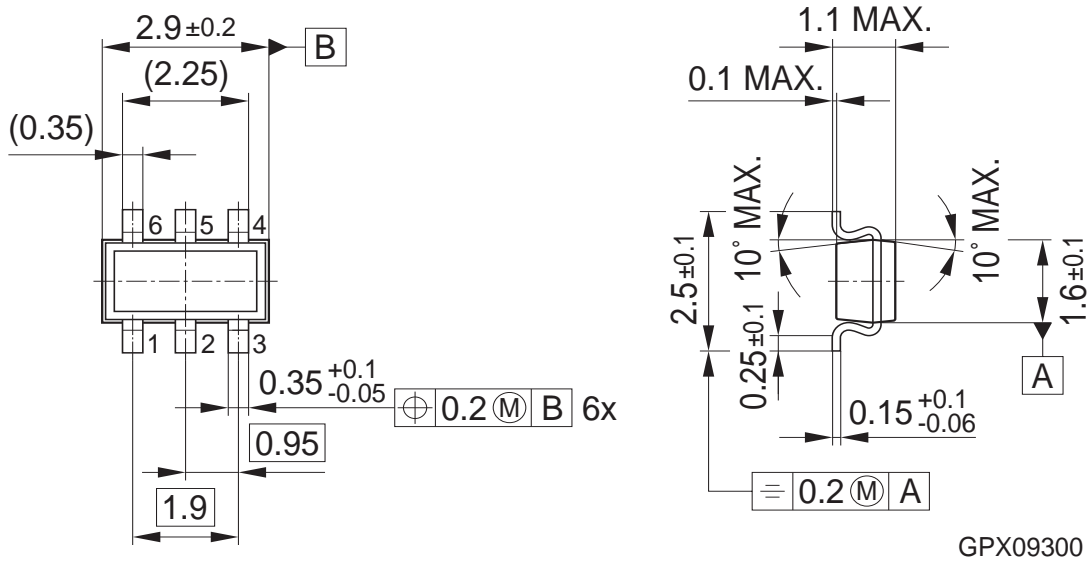

Footprint:

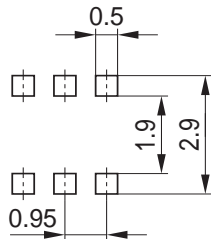

Remark: Wave soldering possible dep. on customers process conditions

HLG09283

Packaging:

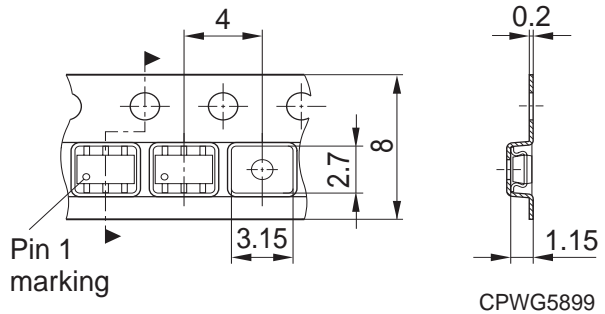

Dimensions in mm



---

**Published by**  
**Infineon Technologies AG**  
**81726 Munich, Germany**  
**© 2009 Infineon Technologies AG**  
**All Rights Reserved.**

**Legal Disclaimer**

The information given in this document shall in no event be regarded as a guarantee of conditions or characteristics. With respect to any examples or hints given herein, any typical values stated herein and/or any information regarding the application of the device, Infineon Technologies hereby disclaims any and all warranties and liabilities of any kind, including without limitation, warranties of non-infringement of intellectual property rights of any third party.

**Information**

For further information on technology, delivery terms and conditions and prices, please contact the nearest Infineon Technologies Office ([www.infineon.com](http://www.infineon.com)).

**Warnings**

Due to technical requirements, components may contain dangerous substances. For information on the types in question, please contact the nearest Infineon Technologies Office. Infineon Technologies components may be used in life-support devices or systems only with the express written approval of Infineon Technologies, if a failure of such components can reasonably be expected to cause the failure of that life-support device or system or to affect the safety or effectiveness of that device or system. Life support devices or systems are intended to be implanted in the human body or to support and/or maintain and sustain and/or protect human life. If they fail, it is reasonable to assume that the health of the user or other persons may be endangered.