

**DESIGNED & DIMENSIONED
IN MILLIMETERS[INCHES]**

**Pb THIS PRODUCT MANUFACTURED
WITH LEAD-FREE PROCESSING**

DO NOT
SCALE FROM
THIS PRINT

RFXXXX-XXXXX-XXXXXX-XXXX

CABLE CALL OUT
174: CCA-174 (RG-174 COAXIAL CABLE)
316: CCA-316 (RG-316 COAXIAL CABLE)
□ 316A: CCS-174525-01-C (RG-316 ACCLIMATE CABLE)

OVERALL CABLE LENGTH
MILLIMETERS OF CABLE
0100 MIN. (SEE NOTE 8 & 9)

FIG 2
CABLE STRIPPING DIMENSIONS
PER CONFIGURATIONS
(SEE TABLE 1)(SEE NOTES 12,13,14,15)

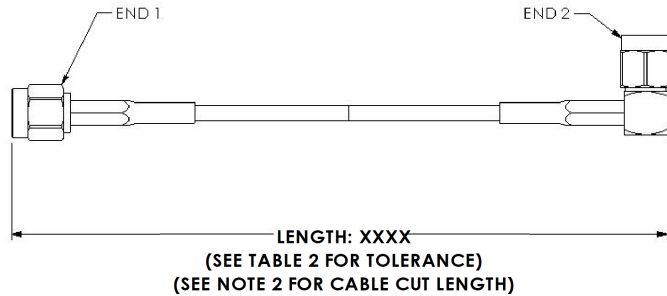
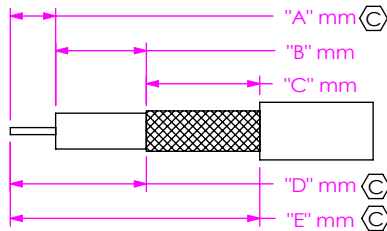

FIG 1
RFXXXX-01SPX-01RPX-XXXX SHOWN

- END 1 CONNECTOR**
-01SP: SMA-P-C-X-ST-CA1 (SEE SHEET 3)
-01RP: SMA-P-C-X-RA-CA1 (SEE SHEET 3)
-01BJ: SMA-J-C-X-ST-BH1 (SEE SHEET 3)
-01BR: SMA-J-C-X-ST-BR1 (SEE SHEET 3)
-02SJ: MCX-J-C-X-ST-CA1 (SEE SHEET 3)
-02RP: MCX-P-C-XX-RA-CA1 (SEE SHEET 3)
-02SP: MCX-P-C-XX-ST-CA1 (SEE SHEET 4)
-03SP: MMCX-P-C-XX-ST-CA1 (SEE SHEET 4)
-03RP: MMCX-P-C-X-RA-CA1 (SEE SHEET 4)
-04SP: BNC5-P-C-XX-ST-CA1 (SEE SHEET 4)
-04BJ: BNC5-J-C-XX-ST-BH1 (SEE SHEET 4)
-05SP: TNC-P-C-XX-ST-CA1 (SEE SHEET 4)
-05BJ: TNC-J-C-XX-ST-BH1 (SEE SHEET 5)
-06BJ: NTPE-J-C-XX-ST-BH1 (SEE SHEET 5)
-07SP: SMB5-P-C-XX-ST-CA1 (SEE SHEET 5)
-07RP: SMB5-P-C-XX-RA-CA1 (SEE SHEET 5)
-07BJ: SMB5-J-C-X-ST-BH1 (SEE SHEET 5)
-13GP: GRFS-P-C-X-ST-CA1
(316 OPTION ONLY) (SEE SHEET 5)
-13GJ: GRFS-J-C-X-ST-CA1
(316 OPTION ONLY) (SEE SHEET 6)
-01SB: SMA-J-C-X-ST-SB1 (SEE SHEET 6)
-01SR: SMA-J-C-X-ST-SR1 (SEE SHEET 6)
-01PN: SMA-J-C4-XX-ST-PN1 (SEE SHEET 6)
* -S7SP: SSMB-P-C-XX-ST-CA1 (SEE SHEET 7)
* -S7RP: SSMB-P-C-XX-RA-CA1 (SEE SHEET 7)
-V3SJ: MMCXV-J-C-XX-ST-CA1 (SEE SHEET 7)
-V3SP: MMCXV-P-C-XX-ST-CA1 (SEE SHEET 7)
-V3RP: MMCXV-P-C-XX-RA-CA1 (SEE SHEET 7)
□ -23GJ: AC-J-C-X-ST-CA1
(316A OPTION ONLY, SEE SHEET 7)
□ -23GP: AC-P-C-X-ST-CA1
(316A OPTION ONLY, SEE SHEET 7)

- END 2 PLATING OPTION**
1: GOLD ALL COMPONENTS
2: GOLD / NICKEL COMBINATION
3: ALTERNATE GOLD / NICKEL
4: ALTERNATE GOLD / GOLD FLASH / NICKEL
7: ALTERNATE GOLD MEDIUM/ GOLD FLASH
(LEAVE BLANK FOR -SING OR -XXXXXX
END 2 PREPARATION)

- END 2 CONNECTOR OR PREPARATION**
-01SP: SMA-P-C-X-ST-CA1 (SEE SHEET 3)
-01RP: SMA-P-C-X-RA-CA1 (SEE SHEET 3)
-01BJ: SMA-J-C-X-ST-BH1 (SEE SHEET 3)
-01BR: SMA-J-C-X-ST-BR1 (SEE SHEET 3)
-02SJ: MCX-J-C-X-ST-CA1 (SEE SHEET 3)
-02RP: MCX-P-C-XX-RA-CA1 (SEE SHEET 3)
-02SP: MCX-P-C-XX-ST-CA1 (SEE SHEET 4)
-03SP: MMCX-P-C-XX-ST-CA1 (SEE SHEET 4)
-03RP: MMCX-P-C-X-RA-CA1 (SEE SHEET 4)
-04SP: BNC5-P-C-XX-ST-CA1 (SEE SHEET 4)
-04BJ: BNC5-J-C-XX-ST-BH1 (SEE SHEET 4)
-05SP: TNC-P-C-XX-ST-CA1 (SEE SHEET 4)
-05BJ: TNC-J-C-XX-ST-BH1 (SEE SHEET 5)
-06BJ: NTPE-J-C-XX-ST-BH1 (SEE SHEET 5)
-07SP: SMB5-P-C-XX-ST-CA1 (SEE SHEET 5)
-07RP: SMB5-P-C-XX-RA-CA1 (SEE SHEET 5)
-07BJ: SMB5-J-C-X-ST-BH1 (SEE SHEET 5)
-13GP: GRFS-P-C-X-ST-CA1
(316 OPTION ONLY) (SEE SHEET 5)
-13GJ: GRFS-J-C-X-ST-CA1
(316 OPTION ONLY) (SEE SHEET 6)
-01SB: SMA-J-C-X-ST-SB1 (SEE SHEET 6)
-01SR: SMA-J-C-X-ST-SR1 (SEE SHEET 6)
-01PN: SMA-J-C4-XX-ST-PN1 (SEE SHEET 6)
-S7SP: SSMB-P-C-XX-ST-CA1 (SEE SHEET 7)
-S7RP: SSMB-P-C-XX-RA-CA1 (SEE SHEET 7)
-V3SJ: MMCXV-J-C-XX-ST-CA1 (SEE SHEET 7)
-V3SP: MMCXV-P-C-XX-ST-CA1 (SEE SHEET 7)
-V3RP: MMCXV-P-C-XX-RA-CA1 (SEE SHEET 7)
□ -23GJ: AC-J-C-X-ST-CA1
(316A OPTION ONLY, SEE SHEET 7)
□ -23GP: AC-P-C-X-ST-CA1
(316A OPTION ONLY, SEE SHEET 7)
-SING: SINGLE ENDED (ONE END ONLY, SEE NOTE 11)
-XXXXXX: STRIPPED AND TINNED (THIS END ONLY-
SEE NOTES 11-15, 18 & SHEET 6, FIG 3)

- END 1 PLATING OPTION**
1: GOLD ALL COMPONENTS
2: GOLD / NICKEL COMBINATION
3: ALTERNATE GOLD / NICKEL
4: ALTERNATE GOLD / GOLD FLASH / NICKEL
7: ALTERNATE GOLD MEDIUM/ GOLD FLASH
(SEE SHEET 3 FOR PLATING SPECIFICS)

□ = FOR INTERNAL USE ONLY,
NOT FOR SALE (SEE NOTE 19)
* = FOR EXISTING CUSTOMERS ONLY

(SEE FIG 2) "C" FORMAT: X.X mm
(SEE FIG 2) "B" FORMAT: X.X mm
(SEE FIG 2) "A" FORMAT: X.X mm

DO NOT LEAVE ANY SPACE BLANK,
EACH MUST CONTAIN A
NUMERIC CHARACTER 0 THRU 9.

NOTES:

- ① REPRESENTS A CRITICAL DIMENSION.
- CABLE CUT LENGTH:
= (LENGTH: XXXX) - (SUBTRACTOR FOR END 1) - (SUBTRACTOR FOR END 2).
(SEE TABLE 1 FOR SUBTRACTORS)
- ASSEMBLY TO BE 100% TESTED FOR OPENS & SHORTS.
- ASSEMBLY TO BE 100% HI-POT TESTED PER TABLE 1, THE TEST VOLTAGE FOR THE ASSEMBLY SHOULD BE SET TO THE END OPTION WITH THE LOWEST TEST VOLTAGE RATING.
- AFTER FINAL ELECTRICAL TESTS, LABEL EACH CABLE ASSEMBLY WITH 1 LABEL -ET
- CRITICALS ON CONNECTOR PRINTS TO BE CHECKED IN PROCESS.
- FINISHED ASSEMBLIES TO BE PACKAGED PER PACKAGING STANDARD CO-RF-WI-3040-M. ASSEMBLIES WITH LOCKWASHERS, NUTS, AND GASKETS TO BE SHIPPED KITTED AS ONE ASSEMBLY PER BAG, UNASSEMBLED.
- CABLE STOCKED IN INCHES, 1 INCH = 25.4 MILLIMETERS.
- CABLE LENGTHS LONGER THAN 1000 MILLIMETERS ARE NOT SUPPORTED BY S.I. TEST DATA.
- MINIMUM BEND RADIUS FOR RF174 = 25.4 [1.00]
RF316 = 12.7 [.50]
RF316A = 12.7 [.50]
- FOR SING ENDED OR STRIPPED AND TINNED ASSEMBLIES: MAKE A DOUBLE ENDED ASSEMBLY AT TWICE THE CABLE LENGTH AND TEST BEFORE CUTTING ASSEMBLY IN HALF.
- DIM "A", "B", AND "C" HAVE A MINIMUM VALUE OF 0.0mm & A MAXIMUM VALUE OF 9.9mm.
- PRODUCTION OF STRIP AND TIN FOR CENTER DIELECTIC USE: A.
- PRODUCTION OF STRIP AND TIN FOR SHIELD USE: D=A+B.
- PRODUCTION OF STRIP AND TIN FOR JACKET USE: E=A+B+C.
- CONNECTORS TO BE ORIENTED ACCORDING TO CO-HD-WI-3048-M.
- FOR BULKHEAD APPLICATIONS, THE END USER SHOULD TIGHTEN THE THREADED NUT TO 15 IN-LB MINIMUM.
- FOR STRIPPED AND TINNED OPTION, ONLY THE CENTER CONDUCTOR IS TINNED.
- USED IN ACRX SERIES.

F:\DWG\MISC\MKTG\RFXXXX-XXXXX-XXXXXX-XXXX-MKT.SLDDRW

**UNLESS OTHERWISE SPECIFIED,
DIMENSIONS ARE IN
MILLIMETERS [INCHES].**
TOLERANCES ARE:
DECIMALS ANGLES
.X: ±0.3 [.01] 2°
.XX: ±0.13 [.005]
.XXX: ±0.051 [.0020]

PROPRIETARY NOTE
THIS DOCUMENT CONTAINS CONFIDENTIAL AND PROPRIETARY INFORMATION AND ALL DESIGN, MANUFACTURING, REPRODUCTION, USE, PATENT RIGHTS AND SALES RIGHTS ARE EXPRESSLY RESERVED BY SAMTEC, INC. THIS DOCUMENT SHALL NOT BE DISCLOSED, IN WHOLE OR PART, TO ANY UNAUTHORIZED PERSON OR ENTITY NOR REPRODUCED, TRANSFERRED OR INCORPORATED IN ANY OTHER PROJECT IN ANY MANNER WITHOUT THE EXPRESS WRITTEN CONSENT OF SAMTEC, INC.

MATERIAL: DO NOT SCALE DRAWING SHEET SCALE: 2:1
SEE END 1 AND END 2 ASSEMBLY PRINTS



520 PARK EAST BLVD, NEW ALBANY, IN 47150
PHONE: 812-944-6733 FAX: 812-948-5047
e-Mail info@SAMTEC.com code 55322

DESCRIPTION: RF316 OR RF-174 CABLE ASSEMBLY
DWG. NO. RFXXXX-XXXXX-XXXXXX-XXXX
BY: TIM P. 09-10-2010 SHEET 1 OF 7

TABLE 1		
CABLE	CABLE CUT LGTH	HI-POT
STYLE	"SUBTRACTOR"	DCV
-01SPX	5.7 [0.22]	1000
-01RPX	2.7 [0.11]	1000
-01BJX	9.0 [0.35]	1000
-01BRX	9.4 [0.37]	1000
-02SJX	6.2 [0.24]	1000
-02RPX	1.7 [0.07]	1000
-02SPX	7.4 [0.29]	630
-03SPX	4.2 [0.17]	1000
-03RPX	1.4 [0.06]	1000
-04SPX	9.0 [0.35]	1000
-04BJX	13.4 [0.53]	1000
-05SPX	9.3 [0.37]	1000
-05BJX	13.4 [0.53]	1000
-06BJX	17.0 [0.67]	1000
-07SPX	7.7 [0.30]	1000
-07RPX	2.8 [0.11]	1000
-07BJX	8.4 [0.33]	1000
-13GPX	5.1 [0.20]	1000
-13GJX	4.2 [0.16]	1000
-01SBX	9.0 [0.35]	1000
-01SRX	9.4 [0.37]	1000
-01PNX	6.2 [0.24]	1000
*-S7SPX	8.1 [0.32]	1000
*-S7RPX	1.5 [0.06]	1000
-V3SJX	4.9 [0.19]	1000
-V3SPX	5.7 [0.22]	1000
-V3RPX	1.5 [0.06]	1000
□ -23GJX	4.4 [0.17]	300
□ -23GPX	5.3 [0.21]	300
-SING	0.00 [0.00]	1000
-XXXXXX	0.00 [0.00]	1000

TABLE 2: FINAL ASSEMBLY LENGTH TOLERANCE	
LENGTH	TOLERANCE
0100-0200 [3.92-7.87]	+3.0 [.12]/-0.0 [.00]
0200-0500 [7.87-19.69]	+5.0 [.20]/-0.0 [.00]
0500-1100 [19.69-43.30]	+10.0 [.40]/-0.0 [.00]
>1100 [43.30]	± 1%

□ = FOR INTERNAL USE ONLY, NOT FOR SALE (SEE NOTE 19)
 * = FOR EXISTING CUSTOMERS ONLY

F:\DWG\MISC\MKTG\RFXXXX-XXXX-XXXX-XXXX-MKT.SLDDRW

<p>PROPRIETARY NOTE</p> <p>THIS DOCUMENT CONTAINS CONFIDENTIAL AND PROPRIETARY INFORMATION AND ALL DESIGN, MANUFACTURING, REPRODUCTION, USE, PATENT RIGHTS AND SALES RIGHTS ARE EXPRESSLY RESERVED BY SAMTEC, INC. THIS DOCUMENT SHALL NOT BE DISCLOSED, IN WHOLE OR PART, TO ANY UNAUTHORIZED PERSON OR ENTITY NOR REPRODUCED, TRANSFERRED OR INCORPORATED IN ANY OTHER PROJECT IN ANY MANNER WITHOUT THE EXPRESS WRITTEN CONSENT OF SAMTEC, INC.</p> <p>DO NOT SCALE DRAWING</p> <p>SHEET SCALE: 1:1</p>			
	<p>520 PARK EAST BLVD, NEW ALBANY, IN 47150 PHONE: 812-944-6733 FAX: 812-948-5047 e-Mail info@SAMTEC.com code 55322</p>		
	<p>DESCRIPTION: RF316 OR RF-174 CABLE ASSEMBLY</p>		
	<p>DWG. NO. RFXXXX-XXXX-XXXXXX-XXXX</p>		
	BY: TIM P.	09-10-2010	SHEET 2 OF 7

-01SP
(STRAIGHT PLUG)

(USE DRAWING No. SMA-P-C-X-ST-CA1
FOR ASSEMBLY INSTRUCTIONS)

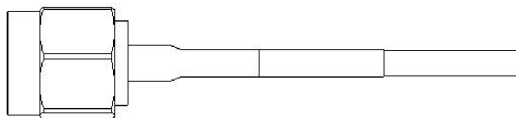

PLATING
1: 30µ" MIN. GOLD CENTER CONTACT
3µ" MIN. GOLD OUTER CONTACT
3µ" MIN. GOLD REMAINING METAL PARTS
(END CONNECTOR P/N: SMA-P-C-H-ST-CA1)

NOTE: ALL CRITICAL DIMENSIONS ON SMA-P-C-X-ST-CA1
THAT APPLY MUST BE VERIFIED.

-01RP
(RIGHT ANGLE PLUG)

(USE DRAWING No. SMA-P-C-X-RA-CA1
FOR ASSEMBLY INSTRUCTIONS)

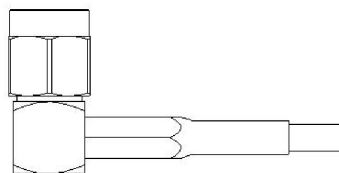

PLATING
1: 30µ" MIN. GOLD CENTER CONTACT
3µ" MIN. GOLD OUTER CONTACT
3µ" MIN. GOLD REMAINING METAL PARTS
(END CONNECTOR P/N: SMA-P-C-H-RA-CA1)

NOTE: ALL CRITICAL DIMENSIONS ON SMA-P-C-X-RA-CA1
THAT APPLY MUST BE VERIFIED.

-01BJ
(STRAIGHT BULKHEAD JACK)
(SEE NOTE 17)

(USE DRAWING No. SMA-J-C-X-ST-BH1
FOR ASSEMBLY INSTRUCTIONS)

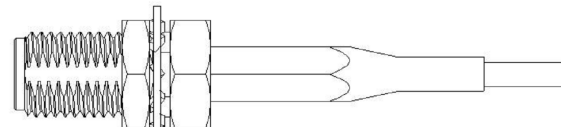

PLATING
1: 30µ" MIN. GOLD CENTER CONTACT
3µ" MIN. GOLD OUTER CONTACT
3µ" MIN. GOLD REMAINING METAL PARTS
(END CONNECTOR P/N: SMA-J-C-H-ST-BH1)

NOTE: ALL CRITICAL DIMENSIONS ON SMA-J-C-X-ST-BH1
THAT APPLY MUST BE VERIFIED.

-01BR (REVERSED POLARITY)
(STRAIGHT BULKHEAD JACK)
(SEE NOTE 17)

(USE DRAWING No. SMA-J-C-X-ST-BR1
FOR ASSEMBLY INSTRUCTIONS)

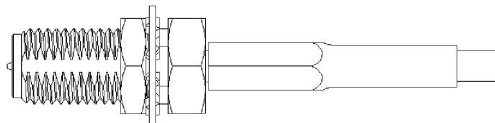

PLATING
1: 30µ" MIN. GOLD CENTER CONTACT
3µ" MIN. GOLD OUTER CONTACT
3µ" MIN. GOLD REMAINING METAL PARTS
(END CONNECTOR P/N: SMA-J-C-H-ST-BR1)

NOTE: ALL CRITICAL DIMENSIONS ON SMA-J-C-X-ST-BR1
THAT APPLY MUST BE VERIFIED.

-02SJ
(STRAIGHT JACK)

(USE DRAWING No. MCX-J-C-X-ST-CA1
FOR ASSEMBLY INSTRUCTIONS)

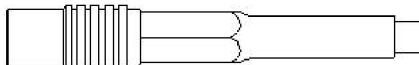

PLATING
1: 30µ" MIN. GOLD CENTER CONTACT
3µ" MIN. GOLD OUTER CONTACT
3µ" MIN. GOLD REMAINING METAL PARTS
(END CONNECTOR P/N: MCX-J-C-H-ST-CA1)

NOTE: ALL CRITICAL DIMENSIONS ON MCX-J-C-X-ST-CA1
THAT APPLY MUST BE VERIFIED.

-02RP
(RIGHT ANGLE PLUG)

(USE DRAWING No. MCX-P-C-XX-RA-CA1
FOR ASSEMBLY INSTRUCTIONS)

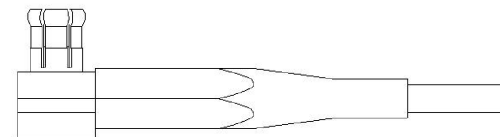

PLATING OPTIONS
1: 30µ" MIN. GOLD CENTER CONTACT
3µ" MIN. GOLD OUTER CONTACT
3µ" MIN. GOLD REMAINING METAL PARTS
(END CONNECTOR P/N: MCX-P-C-H-RA-CA1)

2: 30µ" MIN. GOLD CENTER CONTACT
3µ" MIN. GOLD OUTER CONTACT
100µ" MIN. NICKEL REMAINING METAL PARTS
(END CONNECTOR P/N: MCX-P-C-HN-RA-CA1)

NOTE: ALL CRITICAL DIMENSIONS ON MCX-P-C-XX-RA-CA1
THAT APPLY MUST BE VERIFIED.

F:\DWG\MISC\MKTG\RFXXXX-XXXX-XXXX-XXXX-MKT.SLDDRW

PROPRIETARY NOTE

THIS DOCUMENT CONTAINS CONFIDENTIAL AND PROPRIETARY INFORMATION AND ALL DESIGN, MANUFACTURING, REPRODUCTION, USE, PATENT RIGHTS AND SALES RIGHTS ARE EXPRESSLY RESERVED BY SAMTEC, INC. THIS DOCUMENT SHALL NOT BE DISCLOSED, IN WHOLE OR PART, TO ANY UNAUTHORIZED PERSON OR ENTITY NOR REPRODUCED, TRANSFERRED OR INCORPORATED IN ANY OTHER PROJECT IN ANY MANNER WITHOUT THE EXPRESS WRITTEN CONSENT OF SAMTEC, INC.

DO NOT SCALE DRAWING

SHEET SCALE: 1:1



520 PARK EAST BLVD, NEW ALBANY, IN 47150
PHONE: 812-944-6733 FAX: 812-948-5047
e-Mail info@SAMTEC.com code 55322

DESCRIPTION:
RF316 OR RF-174 CABLE ASSEMBLY

DWG. NO.
RFXXXX-XXXX-XXXXXX-XXXX

BY: TIM P. 09-10-2010 SHEET 3 OF 7

-02SP
(STRAIGHT PLUG)

(USE DRAWING No. MCX-P-C-XX-ST-CA1 FOR ASSEMBLY INSTRUCTIONS)



PLATING OPTIONS

1: 30µ" MIN. GOLD CENTER CONTACT
3µ" MIN. GOLD OUTER CONTACT
3µ" MIN. GOLD REMAINING METAL PARTS
(END CONNECTOR P/N: MCX-P-C-H-ST-CA1)

2: 30µ" MIN. GOLD CENTER CONTACT
3µ" MIN. GOLD OUTER CONTACT
100µ" MIN. NICKEL REMAINING METAL PARTS
(END CONNECTOR P/N: MCX-P-C-HN-ST-CA1)

NOTE: ALL CRITICAL DIMENSIONS ON MCX-P-C-XX-ST-CA1 THAT APPLY MUST BE VERIFIED.

-03SP
(STRAIGHT PLUG)

(USE DRAWING No. MMCX-P-C-XX-ST-CA1 FOR ASSEMBLY INSTRUCTIONS)



PLATING OPTIONS

1: 30µ" MIN. GOLD CENTER CONTACT
3µ" MIN. GOLD OUTER CONTACT
3µ" MIN. GOLD REMAINING METAL PARTS
(END CONNECTOR P/N: MMCX-P-C-H-ST-CA1)

2: 30µ" MIN. GOLD CENTER CONTACT
3µ" MIN. GOLD OUTER CONTACT
100µ" MIN. NICKEL REMAINING METAL PARTS
(END CONNECTOR P/N: MMCX-P-C-HN-ST-CA1)

NOTE: ALL CRITICAL DIMENSIONS ON MMCX-P-C-XX-ST-CA1 THAT APPLY MUST BE VERIFIED.

-03RP
(RIGHT ANGLE PLUG)

(USE DRAWING No. MMCX-P-C-X-RA-CA1 FOR ASSEMBLY INSTRUCTIONS)

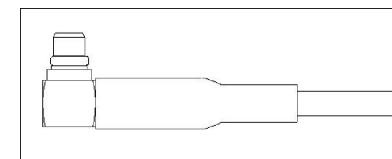

PLATING

1: 30µ" MIN. GOLD CENTER CONTACT
3µ" MIN. GOLD OUTER CONTACT
3µ" MIN. GOLD REMAINING METAL PARTS
(END CONNECTOR P/N: MMCX-P-C-H-RA-CA1)

NOTE: ALL CRITICAL DIMENSIONS ON MMCX-P-C-X-RA-CA1 THAT APPLY MUST BE VERIFIED.

-04SP
(STRAIGHT PLUG)

(USE DRAWING No. BNC5-P-C-XX-ST-CA1 FOR ASSEMBLY INSTRUCTIONS)

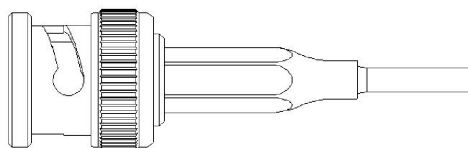

PLATING OPTIONS

2: 30µ" MIN. GOLD CENTER CONTACT
100µ" MIN. NICKEL OUTER CONTACT
100µ" MIN. NICKEL REMAINING METAL PARTS
(END CONNECTOR P/N: BNC5-P-C-HN-ST-CA1)

3: 10µ" MIN. GOLD CENTER CONTACT
100µ" MIN. NICKEL OUTER CONTACT
100µ" MIN. NICKEL REMAINING METAL PARTS
(END CONNECTOR P/N: BNC5-P-C-GN-ST-CA1)

NOTE: ALL CRITICAL DIMENSIONS ON BNC5-P-C-XX-ST-CA1 THAT APPLY MUST BE VERIFIED.

-04BJ
(STRAIGHT BULKHEAD JACK)
(SEE NOTE 17)

(USE DRAWING No. BNC5-J-C-XX-ST-BH1 FOR ASSEMBLY INSTRUCTIONS)

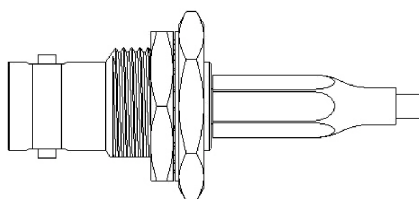

PLATING OPTIONS

2: 30µ" MIN. GOLD CENTER CONTACT
100µ" MIN. NICKEL OUTER CONTACT
100µ" MIN. NICKEL REMAINING METAL PARTS
(END CONNECTOR P/N: BNC5-J-C-HN-ST-BH1)

3: 10µ" MIN. GOLD CENTER CONTACT
100µ" MIN. NICKEL OUTER CONTACT
100µ" MIN. NICKEL REMAINING METAL PARTS
(END CONNECTOR P/N: BNC5-J-C-GN-ST-BH1)

NOTE: ALL CRITICAL DIMENSIONS ON BNC5-J-C-XX-ST-BH1 THAT APPLY MUST BE VERIFIED.

-05SP
(STRAIGHT PLUG)

(USE DRAWING No. TNC-P-C-XX-ST-CA1 FOR ASSEMBLY INSTRUCTIONS)

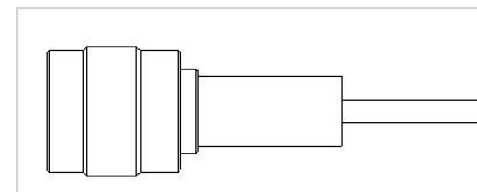

PLATING

3: 10µ" MIN. GOLD CENTER CONTACT
100µ" MIN. NICKEL OUTER CONTACT
100µ" MIN. NICKEL REMAINING METAL PARTS
(END CONNECTOR P/N: TNC-P-C-GN-ST-CA1)

NOTE: ALL CRITICAL DIMENSIONS ON TNC-P-C-XX-ST-CA1 THAT APPLY MUST BE VERIFIED.

PROPRIETARY NOTE
THIS DOCUMENT CONTAINS CONFIDENTIAL AND PROPRIETARY INFORMATION AND ALL DESIGN, MANUFACTURING, REPRODUCTION, USE, PATENT RIGHTS AND SALES RIGHTS ARE EXPRESSLY RESERVED BY SAMTEC, INC. THIS DOCUMENT SHALL NOT BE DISCLOSED, IN WHOLE OR PART, TO ANY UNAUTHORIZED PERSON OR ENTITY NOR REPRODUCED, TRANSFERRED OR INCORPORATED IN ANY OTHER PROJECT IN ANY MANNER WITHOUT THE EXPRESS WRITTEN CONSENT OF SAMTEC, INC.

DO NOT SCALE DRAWING

SHEET SCALE: 1:1



520 PARK EAST BLVD, NEW ALBANY, IN 47150
PHONE: 812-944-6733 FAX: 812-948-5047
e-Mail info@SAMTEC.com code 55322

DESCRIPTION:
RF316 OR RF-174 CABLE ASSEMBLY

DWG. NO.
RFXXXX-XXXXX-XXXXXX-XXXX

BY: TIM P. 09-10-2010 SHEET 4 OF 7

REVISION AN

-05BJ
(STRAIGHT BULKHEAD JACK)
(SEE NOTE 17)

(USE DRAWING No. TNC-J-C-XX-ST-BH1 FOR ASSEMBLY INSTRUCTIONS)

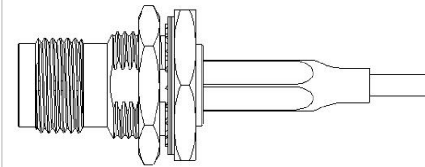

PLATING OPTIONS

2: 30µ" MIN. GOLD CENTER CONTACT
100µ" MIN. NICKEL OUTER CONTACT
100µ" MIN. NICKEL REMAINING METAL PARTS
(END CONNECTOR P/N: TNC-J-C-HN-ST-BH1)

3: 10µ" MIN. GOLD CENTER CONTACT
100µ" MIN. NICKEL OUTER CONTACT
100µ" MIN. NICKEL REMAINING METAL PARTS
(END CONNECTOR P/N: TNC-J-C-GN-ST-BH1)

NOTE: ALL CRITICAL DIMENSIONS ON TNC-J-C-XX-ST-BH1 THAT APPLY MUST BE VERIFIED.

-06BJ
(STRAIGHT BULKHEAD JACK)
(SEE NOTE 17)

(USE DRAWING No. NTPPE-J-C-XX-ST-BH1 FOR ASSEMBLY INSTRUCTIONS)

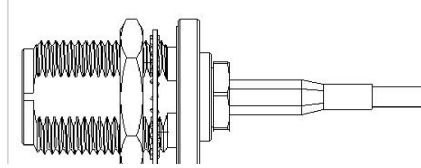

PLATING OPTIONS

2: 30µ" MIN. GOLD CENTER CONTACT
100µ" MIN. NICKEL OUTER CONTACT
100µ" MIN. NICKEL REMAINING METAL PARTS
(END CONNECTOR P/N: NTPPE-J-C-HN-ST-BH1)

3: 10µ" MIN. GOLD CENTER CONTACT
100µ" MIN. NICKEL OUTER CONTACT
100µ" MIN. NICKEL REMAINING METAL PARTS
(END CONNECTOR P/N: NTPPE-J-C-GN-ST-BH1)

NOTE: ALL CRITICAL DIMENSIONS ON NTPPE-J-C-XX-ST-BH1 THAT APPLY MUST BE VERIFIED.

-07SP
(STRAIGHT PLUG)

(USE DRAWING No. SMB5-P-C-XX-ST-CA1 FOR ASSEMBLY INSTRUCTIONS)

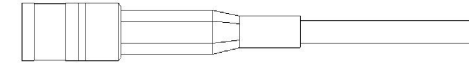

PLATING OPTIONS

1: 30µ" MIN. GOLD CENTER CONTACT
3µ" MIN. GOLD OUTER CONTACT
3µ" MIN. GOLD REMAINING METAL PARTS
(END CONNECTOR P/N: SMB5-P-C-H-ST-CA1)

2: 30µ" MIN. GOLD CENTER CONTACT
3µ" MIN. GOLD OUTER CONTACT
100µ" MIN. NICKEL REMAINING METAL PARTS
(END CONNECTOR P/N: SMB5-P-C-HN-ST-CA1)

NOTE: ALL CRITICAL DIMENSIONS ON SMB5-P-C-XX-ST-CA1 THAT APPLY MUST BE VERIFIED.

-07RP
(RIGHT ANGLE PLUG)

(USE DRAWING No. SMB5-P-C-XX-RA-CA1 FOR ASSEMBLY INSTRUCTIONS)

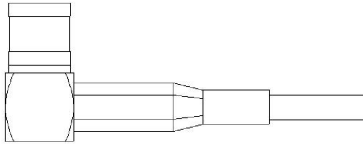

PLATING OPTIONS

1: 30µ" MIN. GOLD CENTER CONTACT
3µ" MIN. GOLD OUTER CONTACT
3µ" MIN. GOLD REMAINING METAL PARTS
(END CONNECTOR P/N: SMB5-P-C-H-RA-CA1)

2: 30µ" MIN. GOLD CENTER CONTACT
3µ" MIN. GOLD OUTER CONTACT
100µ" MIN. NICKEL REMAINING METAL PARTS
(END CONNECTOR P/N: SMB5-P-C-HN-RA-CA1)

NOTE: ALL CRITICAL DIMENSIONS ON SMB5-P-C-XX-RA-CA1 THAT APPLY MUST BE VERIFIED.

-07BJ
(STRAIGHT BULKHEAD JACK)
(SEE NOTE 17)

(USE DRAWING No. SMB5-J-C-X-ST-BH1 FOR ASSEMBLY INSTRUCTIONS)

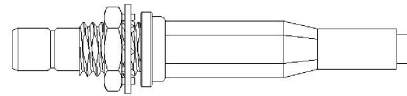

PLATING

1: 30µ" MIN. GOLD CENTER CONTACT
3µ" MIN. GOLD OUTER CONTACT
3µ" MIN. GOLD REMAINING METAL PARTS
(END CONNECTOR P/N: SMB5-J-C-H-ST-BH1)

NOTE: ALL CRITICAL DIMENSIONS ON SMB5-J-C-X-ST-BH1 THAT APPLY MUST BE VERIFIED.

-13GP
(STRAIGHT PLUG)

(USE DRAWING No. GRFS-P-C-X-ST-CA1 FOR ASSEMBLY INSTRUCTIONS)
(316 OPTION ONLY)



PLATING

1: 30µ" MIN. GOLD CENTER CONTACT
3µ" MIN. GOLD OUTER CONTACT
3µ" MIN. GOLD REMAINING METAL PARTS
(END CONNECTOR P/N: GRFS-P-C-H-ST-CA1)

NOTE: ALL CRITICAL DIMENSIONS ON GRFS-P-C-X-ST-CA1 THAT APPLY MUST BE VERIFIED.

F:\DWG\MISC\MKTG\RFXXXX-XXXX-XXXX-XXXX-MKT.SLDDRW

PROPRIETARY NOTE

THIS DOCUMENT CONTAINS CONFIDENTIAL AND PROPRIETARY INFORMATION AND ALL DESIGN, MANUFACTURING, REPRODUCTION, USE, PATENT RIGHTS AND SALES RIGHTS ARE EXPRESSLY RESERVED BY SAMTEC, INC. THIS DOCUMENT SHALL NOT BE DISCLOSED, IN WHOLE OR PART, TO ANY UNAUTHORIZED PERSON OR ENTITY NOR REPRODUCED, TRANSFERRED OR INCORPORATED IN ANY OTHER PROJECT IN ANY MANNER WITHOUT THE EXPRESS WRITTEN CONSENT OF SAMTEC, INC.

DO NOT SCALE DRAWING

SHEET SCALE: 1:1



520 PARK EAST BLVD, NEW ALBANY, IN 47150
PHONE: 812-944-6733 FAX: 812-948-5047
e-Mail info@SAMTEC.com code 55322

DESCRIPTION:
RF316 OR RF-174 CABLE ASSEMBLY

DWG. NO.
RFXXXX-XXXXX-XXXXXX-XXXX

BY: TIM P. 09-10-2010 SHEET 5 OF 7

-13GJ
(STRAIGHT JACK)

(USE DRAWING No. GRFS-J-C-X-ST-CA1
FOR ASSEMBLY INSTRUCTIONS)
(316 OPTION ONLY)

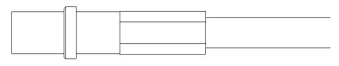

PLATING
1: 30μ" MIN. GOLD CENTER CONTACT
3μ" MIN. GOLD OUTER CONTACT
3μ" MIN. GOLD REMAINING METAL PARTS
(END CONNECTOR P/N: GRFS-J-C-H-ST-CA1)

NOTE: ALL CRITICAL DIMENSIONS ON GRFS-J-C-X-ST-CA1
THAT APPLY MUST BE VERIFIED.

-01SB
(SEALED STRAIGHT BULKHEAD JACK)
(SEE NOTE 17)

(USE DRAWING No. SMA-J-C-X-ST-SB1
FOR ASSEMBLY INSTRUCTIONS)

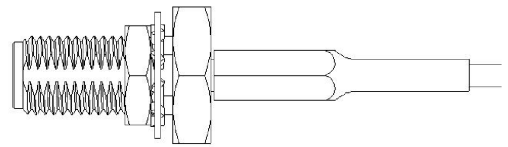

PLATING
1: 30μ" MIN. GOLD CENTER CONTACT
3μ" MIN. GOLD OUTER CONTACT
3μ" MIN. GOLD REMAINING METAL PARTS
(END CONNECTOR P/N: SMA-J-C-H-ST-SB1)

NOTE: ALL CRITICAL DIMENSIONS ON SMA-J-C-X-ST-SB1
THAT APPLY MUST BE VERIFIED.

-01SR (REVERSED POLARITY)
(SEALED STRAIGHT BULKHEAD JACK)
(SEE NOTE 17)

(USE DRAWING No. SMA-J-C-X-ST-SR1
FOR ASSEMBLY INSTRUCTIONS)

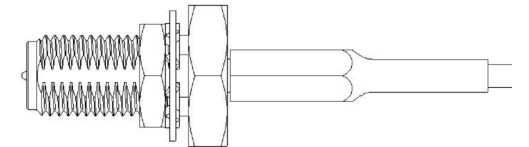

PLATING
1: 30μ" MIN. GOLD CENTER CONTACT
3μ" MIN. GOLD OUTER CONTACT
3μ" MIN. GOLD REMAINING METAL PARTS
(END CONNECTOR P/N: SMA-J-C-H-ST-SR1)

NOTE: ALL CRITICAL DIMENSIONS ON SMA-J-C-X-ST-SR1
THAT APPLY MUST BE VERIFIED.

-01PN
(STRAIGHT PANEL MOUNT JACK)

(USE DRAWING No. SMA-J-C4-XX-ST-PN1
FOR ASSEMBLY INSTRUCTIONS)

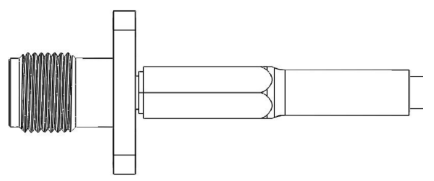

PLATING OPTIONS
1: 30μ" MIN. GOLD CENTER CONTACT
3μ" MIN. GOLD OUTER CONTACT
3μ" MIN. GOLD REMAINING METAL PARTS
(END CONNECTOR P/N: SMA-J-C4-H-ST-PN1)

7: 10μ" MIN. GOLD CENTER CONTACT
3μ" MIN. GOLD OUTER CONTACT
3μ" MIN. GOLD REMAINING METAL PARTS
(END CONNECTOR P/N: SMA-J-C4-GF-ST-PN1)

NOTE: ALL CRITICAL DIMENSIONS ON SMA-J-C4-XX-ST-PN1
THAT APPLY MUST BE VERIFIED.

FIG 3
RFXXX-04BJX-102148-XXXX SHOWN

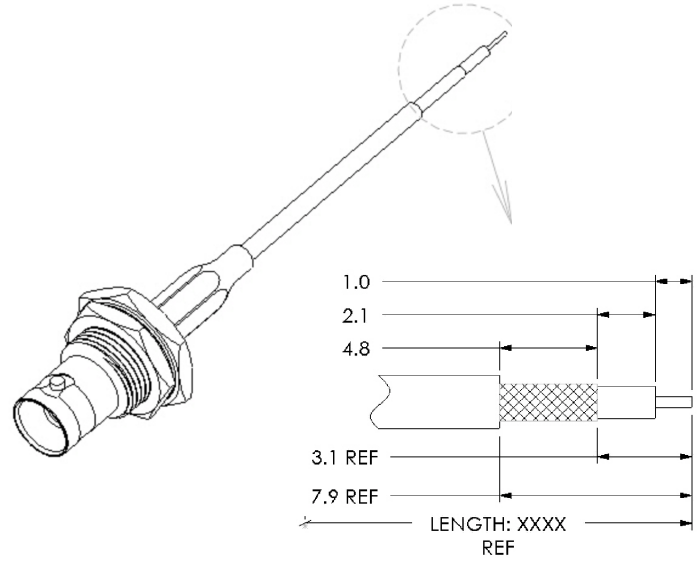

F:\DWG\MISC\MKTG\RFXXX-XXXX-XXXX-XXXX-MKT.SLDDRW

*** PROPRIETARY NOTE ***
THIS DOCUMENT CONTAINS CONFIDENTIAL AND PROPRIETARY INFORMATION AND ALL DESIGN, MANUFACTURING, REPRODUCTION, USE, PATENT RIGHTS AND SALES RIGHTS ARE EXPRESSLY RESERVED BY SAMTEC, INC. THIS DOCUMENT SHALL NOT BE DISCLOSED, IN WHOLE OR PART, TO ANY UNAUTHORIZED PERSON OR ENTITY NOR REPRODUCED, TRANSFERRED OR INCORPORATED IN ANY OTHER PROJECT IN ANY MANNER WITHOUT THE EXPRESS WRITTEN CONSENT OF SAMTEC, INC.

DO NOT SCALE DRAWING

SHEET SCALE: 1:1



520 PARK EAST BLVD, NEW ALBANY, IN 47150
PHONE: 812-944-6733 FAX: 812-948-5047
e-Mail info@SAMTEC.com code 55322

DESCRIPTION:
RF316 OR RF-174 CABLE ASSEMBLY

DWG. NO.
RFXXX-XXXX-XXXX-XXXX

BY: TIM P. 09-10-2010 SHEET 6 OF 7

REVISION AN

***-S7SP**
(STRAIGHT PLUG)

(USE DRAWING No. SSMB-P-C-XX-ST-CA1 FOR ASSEMBLY INSTRUCTIONS)

* = FOR EXISTING CUSTOMERS ONLY



PLATING
4: 10µ" MIN. GOLD CENTER CONTACT
3µ" MIN. GOLD OUTER CONTACT
100µ" MIN. NICKEL REMAINING METAL PARTS
(END CONNECTOR P/N: SSMB-P-C-GF-ST-CA1)

NOTE: ALL CRITICAL DIMENSIONS ON SSMB-P-C-XX-ST-CA1 THAT APPLY MUST BE VERIFIED.

***-S7RP**
(RIGHT ANGLE PLUG)

(USE DRAWING No. SSMB-P-C-XX-RA-CA1 FOR ASSEMBLY INSTRUCTIONS)

* = FOR EXISTING CUSTOMERS ONLY

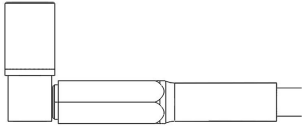

PLATING
4: 10µ" MIN. GOLD CENTER CONTACT
3µ" MIN. GOLD OUTER CONTACT
100µ" MIN. NICKEL REMAINING METAL PARTS
(END CONNECTOR P/N: SSMB-P-C-GF-RA-CA1)

NOTE: ALL CRITICAL DIMENSIONS ON SSMB-P-C-XX-RA-CA1 THAT APPLY MUST BE VERIFIED.

-V3SJ
(STRAIGHT JACK)

(USE DRAWING No. MMCXV-J-C-XX-ST-CA1 FOR ASSEMBLY INSTRUCTIONS)

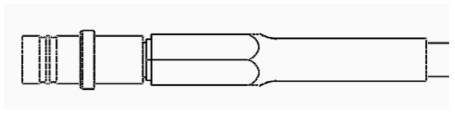

PLATING
1: 30µ" MIN. GOLD CENTER CONTACT
3µ" MIN. GOLD OUTER CONTACT
3µ" MIN. NICKEL REMAINING METAL PARTS
(END CONNECTOR P/N: MMCXV-J-C-HF-ST-CA1)

4: 10µ" MIN. GOLD CENTER CONTACT
3µ" MIN. GOLD OUTER CONTACT
100µ" MIN. NICKEL REMAINING METAL PARTS
(END CONNECTOR P/N: MMCXV-J-C-GF-ST-CA1)

NOTE: ALL CRITICAL DIMENSIONS ON MMCXV-J-C-XX-ST-CA1 THAT APPLY MUST BE VERIFIED.

-V3SP
(STRAIGHT PLUG)

(USE DRAWING No. MMCXV-P-C-XX-ST-CA1 FOR ASSEMBLY INSTRUCTIONS)



PLATING
1: 30µ" MIN. GOLD CENTER CONTACT
3µ" MIN. GOLD OUTER CONTACT
3µ" MIN. NICKEL REMAINING METAL PARTS
(END CONNECTOR P/N: MMCXV-P-C-HF-ST-CA1)

4: 10µ" MIN. GOLD CENTER CONTACT
3µ" MIN. GOLD OUTER CONTACT
100µ" MIN. NICKEL REMAINING METAL PARTS
(END CONNECTOR P/N: MMCXV-P-C-GF-ST-CA1)

NOTE: ALL CRITICAL DIMENSIONS ON MMCXV-P-C-XX-ST-CA1 THAT APPLY MUST BE VERIFIED.

-V3RP
(RIGHT ANGLE PLUG)

(USE DRAWING No. MMCXV-P-C-XX-RA-CA1 FOR ASSEMBLY INSTRUCTIONS)

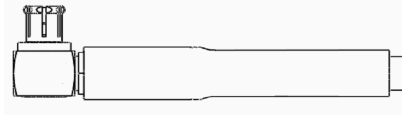

PLATING
1: 30µ" MIN. GOLD CENTER CONTACT
3µ" MIN. GOLD OUTER CONTACT
3µ" MIN. NICKEL REMAINING METAL PARTS
(END CONNECTOR P/N: MMCXV-P-C-HF-RA-CA1)

4: 10µ" MIN. GOLD CENTER CONTACT
3µ" MIN. GOLD OUTER CONTACT
100µ" MIN. NICKEL REMAINING METAL PARTS
(END CONNECTOR P/N: MMCXV-P-C-GF-RA-CA1)

NOTE: ALL CRITICAL DIMENSIONS ON MMCXV-P-C-XX-RA-CA1 THAT APPLY MUST BE VERIFIED.

□ -23GJ
(STRAIGHT JACK)

(USE DRAWING No. AC-J-C-X-ST-CA1 FOR ASSEMBLY INSTRUCTIONS)

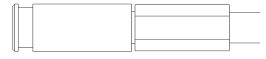

PLATING
1: 30µ" MIN. GOLD CENTER CONTACT
3µ" MIN. GOLD OUTER CONTACT
3µ" MIN. NICKEL REMAINING METAL PARTS
(END CONNECTOR P/N: AC-J-C-H-ST-CA1)

NOTE: ALL CRITICAL DIMENSIONS ON AC-J-C-X-ST-CA1 THAT APPLY MUST BE VERIFIED.

□ = FOR INTERNAL USE ONLY, NOT FOR SALE (SEE NOTE 19)

□ -23GP
(STRAIGHT PLUG)

(USE DRAWING No. AC-P-C-X-ST-CA1 FOR ASSEMBLY INSTRUCTIONS)

□ = FOR INTERNAL USE ONLY, NOT FOR SALE (SEE NOTE 19)

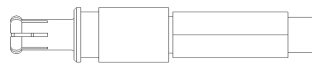

PLATING
1: 30µ" MIN. GOLD CENTER CONTACT
3µ" MIN. GOLD OUTER CONTACT
3µ" MIN. NICKEL REMAINING METAL PARTS
(END CONNECTOR P/N: AC-P-C-H-ST-CA1)

NOTE: ALL CRITICAL DIMENSIONS ON AC-P-C-X-ST-CA1 THAT APPLY MUST BE VERIFIED.

F:\DWG\MISC\MKTG\RFXXXX-XXXX-XXXX-XXXX-MKT.SLDDRW

PROPRIETARY NOTE
THIS DOCUMENT CONTAINS CONFIDENTIAL AND PROPRIETARY INFORMATION AND ALL DESIGN, MANUFACTURING, REPRODUCTION, USE, PATENT RIGHTS AND SALES RIGHTS ARE EXPRESSLY RESERVED BY SAMTEC, INC. THIS DOCUMENT SHALL NOT BE DISCLOSED, IN WHOLE OR PART, TO ANY UNAUTHORIZED PERSON OR ENTITY NOR REPRODUCED, TRANSFERRED OR INCORPORATED IN ANY OTHER PROJECT IN ANY MANNER WITHOUT THE EXPRESS WRITTEN CONSENT OF SAMTEC, INC.

DO NOT SCALE DRAWING
SHEET SCALE: 2:1



520 PARK EAST BLVD, NEW ALBANY, IN 47150
PHONE: 812-944-6733 FAX: 812-948-5047
e-Mail info@SAMTEC.com code 55322

DESCRIPTION:
RF316 OR RF-174 CABLE ASSEMBLY
DWG. NO.
RFXXXX-XXXX-XXXXXX-XXXX
BY: TIM P. 09-10-2010 SHEET 7 OF 7