



FEATURES

- RoHS compliant
- 2:1 wide range voltage input
- Continuous short circuit protection with current foldback
- Operating temperature range -40°C to 85°C
- 0.75% regulation
- 1kVDC isolation
- Efficiency to 83%
- Power density 0.9W/cm³
- 5V, 12V & 24V nominal inputs
- 5V, 9V, 12V & 15V outputs
- No electrolytic capacitors
- Fully encapsulated
- External control
- Low noise

DESCRIPTION

The NDL series is a range of high performance miniature DC-DC converters having regulated outputs over the wide temperature range of -40°C to 85°C. The input voltage range is 2:1 with the output power at 2 watts and the input to output isolation is 1kVDC. Continuous short circuit protection, external control and extremely small SIP packaging provide state of the art functionality. Nominal input voltages of 5, 12, 24 and 48V with output voltages of 5, 9, 12 and 15V are available as standard with custom parts on request. The plastic case is rated to UL94V-0 with encapsulant to UL94V-1.

SELECTION GUIDE

Order Code	Input Voltage V (nom.)	Rated Output Voltage V	Output Current ¹		Input Current ²	Efficiency %	Isolation Capacitance pF	MTTF ⁴ kHrs	Recommended Alternative
			Min Load ³ mA	Full Load mA	Full Load mA				
			Recommended		In Production				
NDL0505SC	5	5	100	400	606	66	26	2015	
NDL0509SC	5	9	55	222	558	71	27	1998	
NDL1205SC	12	5	100	400	228	73	39	1994	
NDL2405SC	24	5	100	400	112	74	37	1722	
NDL2409SC	24	9	55	222	102	81	40	1711	
NDL2412SC	24	12	42	167	100	83	51	1696	
NDL2415SC	24	15	33	134	100	83	58	1685	
To be discontinued									
NDL1212SC	12	12	42	167	208	80	47	1961	NCS3S1212SC
NDL1215SC	12	15	33	134	206	81	47	1947	NCS3S1215SC
NDL4805SC	48	5	100	400	57	73	39	1719	NCS3S4805SC
NDL4815SC	48	15	33	134	51	82	65	1683	NCS3S4815SC
Discontinued									
NDL0512SC	5	12	42	167	559	71	26	1980	Contact Murata
NDL0515SC	5	15	33	134	549	73	27	1965	Contact Murata
NDL1209SC	12	9	55	222	211	79	38	1981	Contact Murata
NDL4809SC	48	9	55	222	52	80	40	1709	Contact Murata
NDL4812SC	48	12	42	167	51	81	53	1694	NCS3S4812SC

INPUT CHARACTERISTICS

Parameter	Conditions	Min.	Typ.	Max.	Units
Voltage range	All NDL05 types	4.5	5	9	VDC
	All NDL12 types	9	12	18	
	All NDL24 types	18	24	36	
	All NDL48 types	36	48	72	
Reflected ripple current	All NDL05 types with 100µF at input			250	mA p-p
	All NDL12 types with 100µF at input			150	
	All NDL24 types with 10µF at input		300	380	
	All NDL48 types with 10µF at input		140	170	

1. Refer to power derating graph for operating of 5V input types at 4.5 to 6V.
 2. Measured at full load with external input/output capacitors.
 3. Please refer to minimum load application notes section on page 3.
 4. Calculated using MIL-HDBK-217F with nominal input voltage at full load.
- All specifications typical at T_a=25°C, nominal input voltage and rated output current unless otherwise specified.



For full details go to
<https://www.murata.com/en-global/products/power/rohs>

OUTPUT CHARACTERISTICS					
Parameter	Conditions ¹	Typ.	Max.	Units	
Voltage set point accuracy	All NDL05/12 input types with external input/output capacitors	±1	±3		%
	All NDL24/48 input types with external input/output capacitors	±2	±5		
Line regulation	All NDL05/12 input types, low line to high line with external input/output capacitors	0.05	0.5		%
	All NDL24/48 input types, low line to high line with external input/output capacitors	0.04	0.4		
Load regulation	All NDL05/12 input types, minimum load to rated load with external input/output capacitors	0.2	0.75		%
	All NDL24/48 input types, minimum load to rated load with external input/output capacitors	0.2	0.75		
Ripple	B/W = 20MHz to 300kHz with external input/output capacitors	5	10		mV rms
Noise	All NDL05 input types, B/W =DC to 20MHz with external input/output capacitors	50	100		mV p-p
	All NDL12 input types, B/W =DC to 20MHz with external input/output capacitors	110	170		
	All NDL24/48 input types, B/W =DC to 20MHz with external input/output capacitors	50	100		
Shutdown power	+V _{IN} nominal	2.8			mW

ISOLATION CHARACTERISTICS					
Parameter	Conditions	Min.	Typ.	Max.	Units
Isolation test voltage	Flash tested for 1 second	1000			V _{DC}
Resistance	V _{ISO} = 1000VDC	1			GΩ

GENERAL CHARACTERISTICS					
Parameter	Conditions	Min.	Typ.	Max.	Units
Control pin (CTRL) input current	Please refer to control pin application note	6	10	15	mA
Switching frequency	Max. rated load to Min. rated load, V _{IN} Min. to V _{IN} Max.	100		600	kHz

TEMPERATURE CHARACTERISTICS					
Parameter	Conditions	Min.	Typ.	Max.	Units
Operation		-40		85	°C
Storage		-50		130	
Cooling	Free air convection				

ABSOLUTE MAXIMUM RATINGS	
Short-circuit protection	Continuous
Lead temperature 1.5mm from case for 10 seconds	260°C
Wave Solder	Wave Solder profile not to exceed the profile recommended in IEC 61760-1 Section 6.1.3. Please refer to application notes for further information.
Control pin input current	15mA
Input voltage 05 types	10V
Input voltage 12 types	20V
Input voltage 24 types	40V
Input voltage 48 types	80V

1. Refer to recommended test circuit for external input/output capacitors.

TECHNICAL NOTES

ISOLATION VOLTAGE

'Hi Pot Test', 'Flash Tested', 'Withstand Voltage', 'Proof Voltage', 'Dielectric Withstand Voltage' & 'Isolation Test Voltage' are all terms that relate to the same thing, a test voltage, applied for a specified time, across a component designed to provide electrical isolation, to verify the integrity of that isolation.

Murata Power Solutions NDL series of DC-DC converters are all 100% production tested at their stated isolation voltage. This is 1kVDC for 1 second.

A question commonly asked is, "What is the continuous voltage that can be applied across the part in normal operation?"

For a part holding no specific agency approvals, such as the NDL series, both input and output should normally be maintained within SELV limits i.e. less than 42.4V peak, or 60VDC. The isolation test voltage represents a measure of immunity to transient voltages and the part should never be used as an element of a safety isolation system. The part could be expected to function correctly with several hundred volts offset applied continuously across the isolation barrier; but then the circuitry on both sides of the barrier must be regarded as operating at an unsafe voltage and further isolation/insulation systems must form a barrier between these circuits and any user-accessible circuitry according to safety standard requirements.

REPEATED HIGH-VOLTAGE ISOLATION TESTING

It is well known that repeated high-voltage isolation testing of a barrier component can actually degrade isolation capability, to a lesser or greater degree depending on materials, construction and environment. The NDL series has an EI ferrite core, with no additional insulation between primary and secondary windings of enamelled wire. While parts can be expected to withstand several times the stated test voltage, the isolation capability does depend on the wire insulation. Any material, including this enamel (typically polyurethane) is susceptible to eventual chemical degradation when subject to very high applied voltages thus implying that the number of tests should be strictly limited. We therefore strongly advise against repeated high voltage isolation testing, but if it is absolutely required, that the voltage be reduced by 20% from specified test voltage.

This consideration equally applies to agency recognised parts rated for better than functional isolation where the wire enamel insulation is always supplemented by a further insulation system of physical spacing or barriers.

RoHS COMPLIANT INFORMATION



This series is compatible with RoHS soldering systems with a peak wave solder temperature of 260°C for 10 seconds. Please refer to [application notes](#) for further information. The pin termination finish on this product series is Tin Plate, Hot Dipped over Matte Tin with Nickel Preplate. The series is backward compatible with Sn/Pb soldering systems.

For further information, please visit www.murata-ps.com/rohs

PART NUMBER STRUCTURE

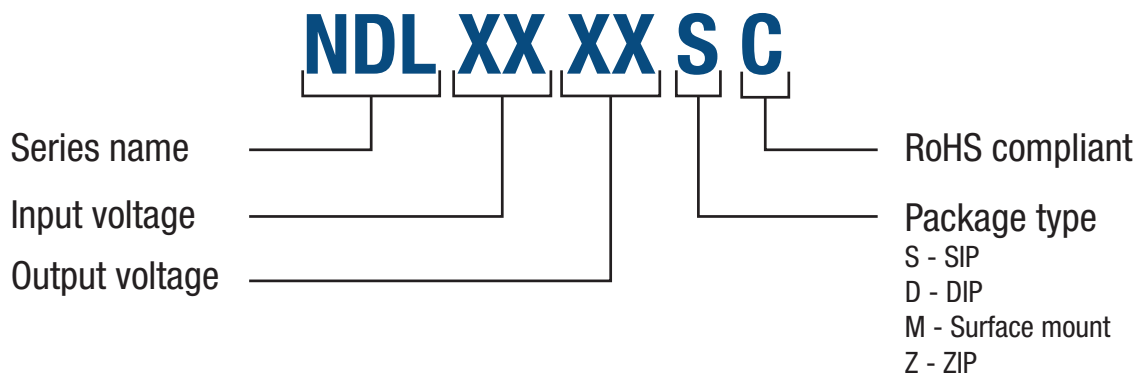

APPLICATION NOTES

External capacitance

Although these converters will work without external capacitors, they are necessary in order to guarantee the full parametric performance over the full line and load range. All parts have been tested and characterized using the following values and test circuit.

Input Voltage (V)	Value	
	C _{IN}	C _{OUT}
5 & 12	100µF, 25V	100µF, 25V
24 & 48	10µF, 200V	100µF, 25V

Test circuit

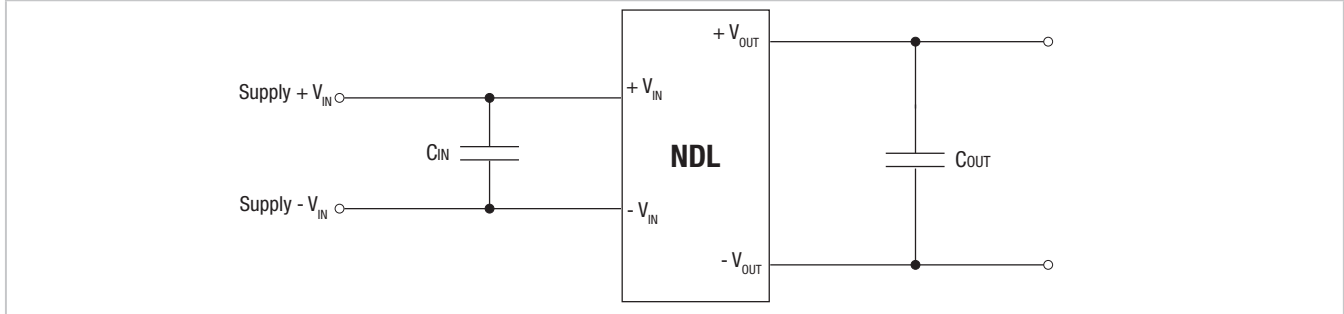

Control Pin

The NDL converters have a shutdown feature which enables the user to put the converter into a low power state. The control pin connects directly to the base of an internal transistor, and the switch off mechanism for the NDL works by forward biasing this NPN transistor. If the pin is left open (high impedance), the converter will be ON (there is no allowed low state for this pin), but once a control voltage is applied with sufficient drive current, the converter will be switched OFF. A suitable application circuit is shown below.

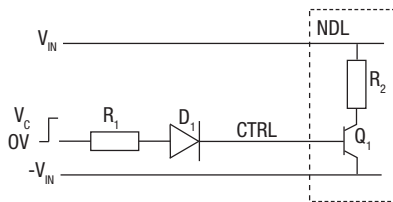

D₁ (e.g. 1N4001) is required to provide high impedance when the signal is low. From the NDL specification, the drive current to operate this function is recommended to be 10mA, and hence the value of R₁ can be derived as follows:

$$R_1 = \frac{V_c - V_D - V_0}{I_c}$$

Assuming V_c=5V, V_D=0.7V and V₀=1V:

$$R_1 = \frac{5 - 0.7 - 1.0}{10 \times 10^{-3}} = 330\Omega$$

Pin 8 (C_s)

This pin provides a connection point to the main reservoir capacitor. Additional capacitance can be added from this pin to pin 7. Any lower ESR capacitor will remove ripple and noise to some degree. The benefit of this access point over simple additional output capacitance is that it precedes the output filter inductor. Maximum values of external capacitance will be dependent on the output voltage, the loading of the converter and the desired ripple figure. Values can be up to 100µF.

Minimum load

The minimum load for correct operation is 25% of the full rated load across the specified input voltage range. Lower loads may cause a significant increase in output ripple and may cause the output voltage to exceed its specification transiently during power-down when the input voltage also falls below its rated minimum.

NDL05 POWER DERATING CURVE

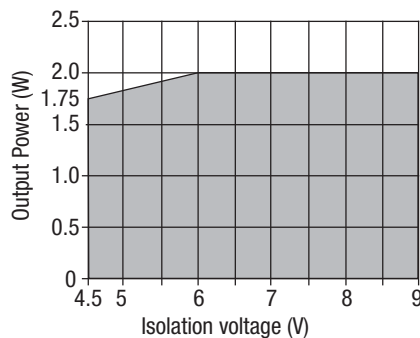

PACKAGE SPECIFICATIONS

MECHANICAL DIMENSIONS

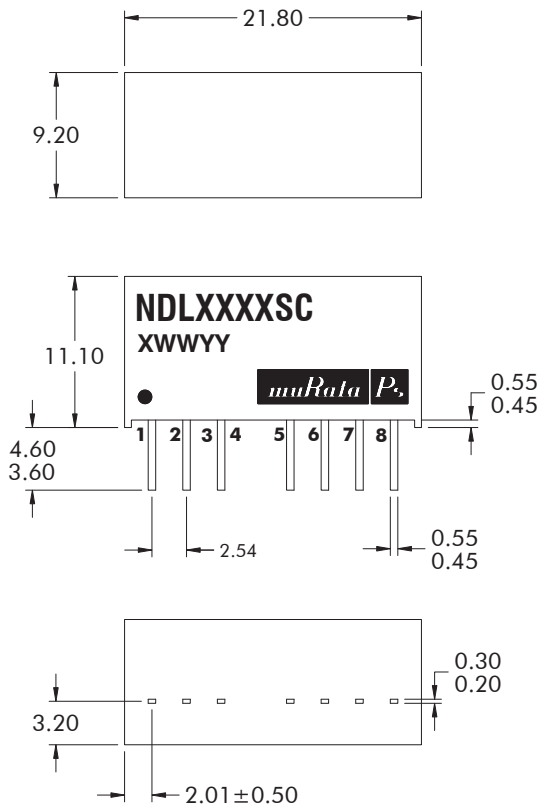

All dimensions in mm ± 0.25 mm. All pins on a 2.54 pitch and within 0.25 of true position.

Weight: 5.0g

PIN CONNECTIONS

Pin	Function
1	-VIN
2	+VIN
3	CTRL
5*	IC
6	+VOUT
7	-VOUT
8	Cs

* This pin is internally connected, and must have no external connection and is used for mechanical reasons. External connection to anything will result in converter failure.

TUBE OUTLINE DIMENSIONS

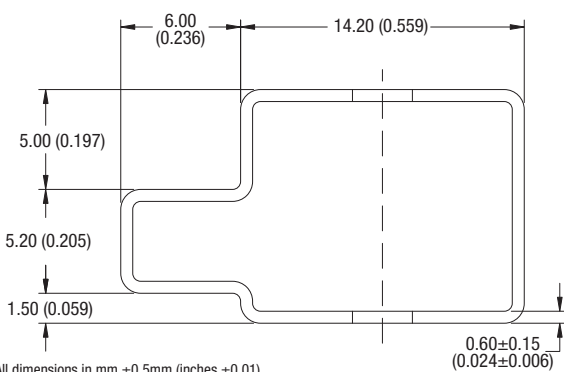

All dimensions in mm ± 0.5 mm (inches ± 0.01).
Tube length : 520mm ± 2 mm (20.47 ± 0.079).

Tube Quantity : 23

RECOMMENDED FOOTPRINT DETAILS

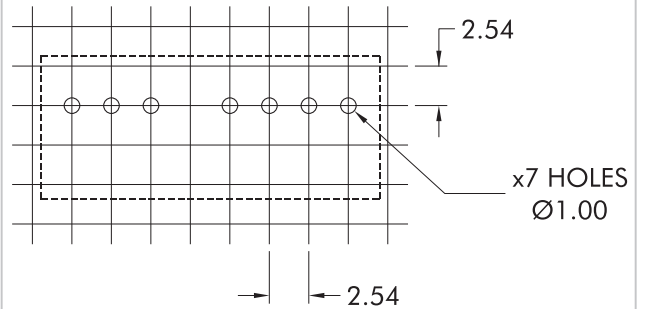

All dimensions in mm ± 0.5 mm.

DISCLAIMER

Unless otherwise stated in the datasheet, all products are designed for standard commercial and industrial applications and NOT for safety-critical and/or life-critical applications.

Particularly for safety-critical and/or life-critical applications, i.e. applications that may directly endanger or cause the loss of life, inflict bodily harm and/or loss or severe damage to equipment/property, and severely harm the environment, a prior explicit written approval from Murata is strictly required. Any use of Murata standard products for any safety-critical, life-critical or any related applications without any prior explicit written approval from Murata shall be deemed unauthorised use.

These applications include but are not limited to:

- Aircraft equipment
- Aerospace equipment
- Undersea equipment
- Power plant control equipment
- Medical equipment
- Transportation equipment (automobiles, trains, ships, etc.)
- Traffic signal equipment
- Disaster prevention / crime prevention equipment
- Data Processing equipment

Murata makes no express or implied warranty, representation, or guarantee of suitability, fitness for any particular use/purpose and/or compatibility with any application or device of the buyer, nor does Murata assume any liability whatsoever arising out of unauthorised use of any Murata product for the application of the buyer. The suitability, fitness for any particular use/purpose and/or compatibility of Murata product with any application or device of the buyer remain to be the responsibility and liability of the buyer.

Buyer represents and agrees that it has all the necessary expertise to create and implement safeguards that anticipate dangerous consequences of failures, monitor failures and their consequences, lessen the likelihood of failures that might cause harm, and take appropriate remedial actions. Buyer will fully indemnify and hold Murata, its affiliated companies, and its representatives harmless against any damages arising out of unauthorised use of any Murata products in any safety-critical and/or life-critical applications.

Remark: Murata in this section refers to Murata Manufacturing Company and its affiliated companies worldwide including, but not limited to, Murata Power Solutions.



This product is subject to the following [operating requirements](#) and the [Life and Safety Critical Application Sales Policy](#):

Refer to: <https://www.murata.com/en-eu/products/power/requirements>

Murata Power Solutions (Milton Keynes) Ltd. makes no representation that the use of its products in the circuits described herein, or the use of other technical information contained herein, will not infringe upon existing or future patent rights. The descriptions contained herein do not imply the granting of licenses to make, use, or sell equipment constructed in accordance therewith. Specifications are subject to change without notice.

© 2022 Murata Power Solutions (Milton Keynes) Ltd.