

## Cool MOS™ Power Transistor

### Feature

- New revolutionary high voltage technology
- Ultra low gate charge
- Periodic avalanche rated
- Extreme dv/dt rated
- High peak current capability
- Improved transconductance
- Pb-free lead plating; RoHS compliant, available in Halogen free mold compound<sup>a)</sup>
- Fully qualified according to JEDEC for Industrial Applications



$V_{DS} @ T_{jmax}$	650	V
$R_{DS(on)}$	0.95	$\Omega$
$I_D$	4.5	A

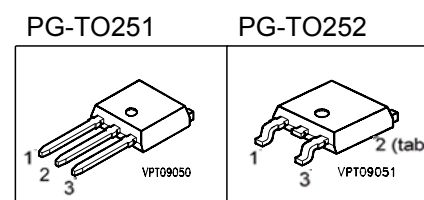

Type	Package	Marking
SPD04N60C3	PG-TO252	04N60C3
SPU04N60C3	PG-TO251	04N60C3

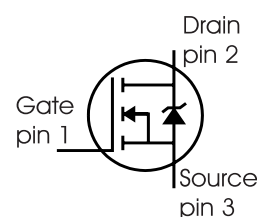

### Maximum Ratings

Parameter	Symbol	Value	Unit
Continuous drain current $T_C = 25\text{ °C}$ $T_C = 100\text{ °C}$	$I_D$	4.5 2.8	A
Pulsed drain current, $t_p$ limited by $T_{jmax}$	$I_{D\text{ puls}}$	13.5	
Avalanche energy, single pulse $I_D = 3.4\text{ A}$ , $V_{DD} = 50\text{ V}$	$E_{AS}$	130	mJ
Avalanche energy, repetitive $t_{AR}$ limited by $T_{jmax}$ <sup>1</sup> $I_D = 4.5\text{ A}$ , $V_{DD} = 50\text{ V}$	$E_{AR}$	0.4	
Avalanche current, repetitive $t_{AR}$ limited by $T_{jmax}$	$I_{AR}$	4.5	A
Gate source voltage static	$V_{GS}$	$\pm 20$	V
Gate source voltage AC ( $f > 1\text{ Hz}$ )	$V_{GS}$	$\pm 30$	
Power dissipation, $T_C = 25\text{ °C}$	$P_{tot}$	50	W
Operating and storage temperature	$T_j, T_{stg}$	-55... +150	$^{\circ}\text{C}$
Reverse diode dv/dt <sup>5)</sup>	dv/dt	15	V/ns

<sup>a)</sup> non-Halogen free (OPN: SPD04N60C3BT), Halogen free (OPN: SPD04N60C3AT)

**Maximum Ratings**

Parameter	Symbol	Value	Unit
Drain Source voltage slope $V_{DS} = 480 \text{ V}$ , $I_D = 4.5 \text{ A}$ , $T_j = 125 \text{ }^\circ\text{C}$	$dv/dt$	50	V/ns

**Thermal Characteristics**

Parameter	Symbol	Values			Unit
		min.	typ.	max.	
Thermal resistance, junction - case	$R_{thJC}$	-	-	2.5	K/W
Thermal resistance, junction - ambient, leaded	$R_{thJA}$	-	-	75	
SMD version, device on PCB: @ min. footprint @ 6 cm <sup>2</sup> cooling area <sup>2)</sup>	$R_{thJA}$	-	-	75 50	
Soldering temperature, *) 1.6 mm (0.063 in.) from case for 10s	$T_{sold}$	-	-	260	$^\circ\text{C}$

**Electrical Characteristics, at  $T_j=25^\circ\text{C}$  unless otherwise specified**

Parameter	Symbol	Conditions	Values			Unit
			min.	typ.	max.	
Drain-source breakdown voltage	$V_{(BR)DSS}$	$V_{GS}=0\text{V}$ , $I_D=0.25\text{mA}$	600	-	-	V
Drain-Source avalanche breakdown voltage	$V_{(BR)DS}$	$V_{GS}=0\text{V}$ , $I_D=4.5\text{A}$	-	700	-	
Gate threshold voltage	$V_{GS(th)}$	$I_D=200\mu\text{A}$ , $V_{GS}=V_{DS}$	2.1	3	3.9	
Zero gate voltage drain current	$I_{DSS}$	$V_{DS}=600\text{V}$ , $V_{GS}=0\text{V}$ , $T_j=25^\circ\text{C}$ , $T_j=150^\circ\text{C}$	-	0.5	1 50	$\mu\text{A}$
Gate-source leakage current	$I_{GSS}$	$V_{GS}=30\text{V}$ , $V_{DS}=0\text{V}$	-	-	100	nA
Drain-source on-state resistance	$R_{DS(on)}$	$V_{GS}=10\text{V}$ , $I_D=2.8\text{A}$ , $T_j=25^\circ\text{C}$ $T_j=150^\circ\text{C}$	-	0.85 2.3	0.95 -	$\Omega$
Gate input resistance	$R_G$	$f=1\text{MHz}$ , open Drain	-	0.95	-	

\*) TO252: reflow soldering, MSL1; TO251: wavesoldering

**Electrical Characteristics** , at  $T_j = 25\text{ }^\circ\text{C}$ , unless otherwise specified

Parameter	Symbol	Conditions	Values			Unit
			min.	typ.	max.	
Transconductance	$g_{fs}$	$V_{DS} \geq 2 \cdot I_D \cdot R_{DS(on)max}$ , $I_D = 2.8\text{A}$	-	4.4	-	S
Input capacitance	$C_{iss}$	$V_{GS} = 0\text{V}$ , $V_{DS} = 25\text{V}$ , $f = 1\text{MHz}$	-	490	-	pF
Output capacitance	$C_{oss}$		-	160	-	
Reverse transfer capacitance	$C_{rss}$		-	15	-	
Effective output capacitance, <sup>3)</sup> energy related	$C_{o(er)}$	$V_{GS} = 0\text{V}$ , $V_{DS} = 0\text{V to } 480\text{V}$	-	20	-	pF
Effective output capacitance, <sup>4)</sup> time related	$C_{o(tr)}$		-	35	-	
Turn-on delay time	$t_{d(on)}$	$V_{DD} = 380\text{V}$ , $V_{GS} = 0/10\text{V}$ , $I_D = 4.5\text{A}$ , $R_G = 18\Omega$	-	6	-	ns
Rise time	$t_r$		-	2.5	-	
Turn-off delay time	$t_{d(off)}$		-	58.5	80	
Fall time	$t_f$		-	9.5	14	

**Gate Charge Characteristics**

Gate to source charge	$Q_{gs}$	$V_{DD} = 480\text{V}$ , $I_D = 4.5\text{A}$	-	2.2	-	nC
Gate to drain charge	$Q_{gd}$		-	8.8	-	
Gate charge total	$Q_g$	$V_{DD} = 480\text{V}$ , $I_D = 4.5\text{A}$ , $V_{GS} = 0\text{ to } 10\text{V}$	-	19	25	
Gate plateau voltage	$V_{(plateau)}$	$V_{DD} = 480\text{V}$ , $I_D = 4.5\text{A}$	-	5	-	V

<sup>1</sup> Repetitive avalanche causes additional power losses that can be calculated as  $P_{AV} = E_{AR} \cdot f$ .

<sup>2</sup> Device on 40mm\*40mm\*1.5mm epoxy PCB FR4 with 6cm<sup>2</sup> (one layer, 70 μm thick) copper area for drain connection. PCB is vertical without blown air.

<sup>3</sup>  $C_{o(er)}$  is a fixed capacitance that gives the same stored energy as  $C_{oss}$  while  $V_{DS}$  is rising from 0 to 80%  $V_{DSS}$ .

<sup>4</sup>  $C_{o(tr)}$  is a fixed capacitance that gives the same charging time as  $C_{oss}$  while  $V_{DS}$  is rising from 0 to 80%  $V_{DSS}$ .

<sup>5</sup>  $I_{SD} \leq I_D$ ,  $di/dt \leq 400\text{A}/\mu\text{s}$ ,  $V_{DClink} = 400\text{V}$ ,  $V_{peak} < V_{BR, DSS}$ ,  $T_j < T_{j,max}$ .  
Identical low-side and high-side switch.

**Electrical Characteristics**, at  $T_j = 25\text{ }^\circ\text{C}$ , unless otherwise specified

Parameter	Symbol	Conditions	Values			Unit
			min.	typ.	max.	
Inverse diode continuous forward current	$I_S$	$T_C=25^\circ\text{C}$	-	-	4.5	A
Inverse diode direct current, pulsed	$I_{SM}$		-	-	13.5	
Inverse diode forward voltage	$V_{SD}$	$V_{GS}=0\text{V}, I_F=I_S$	-	1	1.2	V
Reverse recovery time	$t_{rr}$	$V_R=480\text{V}, I_F=I_S,$	-	300	500	ns
Reverse recovery charge	$Q_{rr}$	$di_F/dt=100\text{A}/\mu\text{s}$	-	2.6	-	$\mu\text{C}$
Peak reverse recovery current	$I_{rrm}$		-	18	-	A
Peak rate of fall of reverse recovery current	$di_{rr}/dt$		-	-	900	$\text{A}/\mu\text{s}$

**Typical Transient Thermal Characteristics**

Symbol	Value	Unit	Symbol	Value	Unit
	typ.			typ.	
Thermal resistance			Thermal capacitance		
$R_{th1}$	0.039	K/W	$C_{th1}$	0.00007347	Ws/K
$R_{th2}$	0.074		$C_{th2}$	0.0002831	
$R_{th3}$	0.132		$C_{th3}$	0.0004062	
$R_{th4}$	0.555		$C_{th4}$	0.001215	
$R_{th5}$	0.529		$C_{th5}$	0.00276	
$R_{th6}$	0.169		$C_{th6}$	0.029	

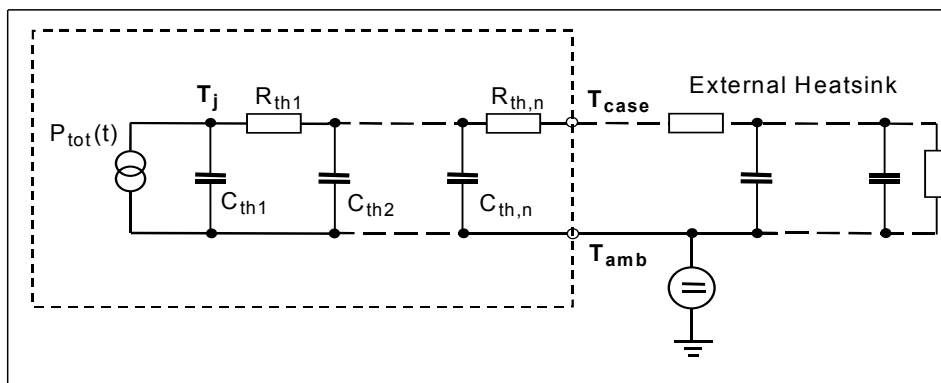

### 1 Power dissipation

$$P_{tot} = f(T_C)$$

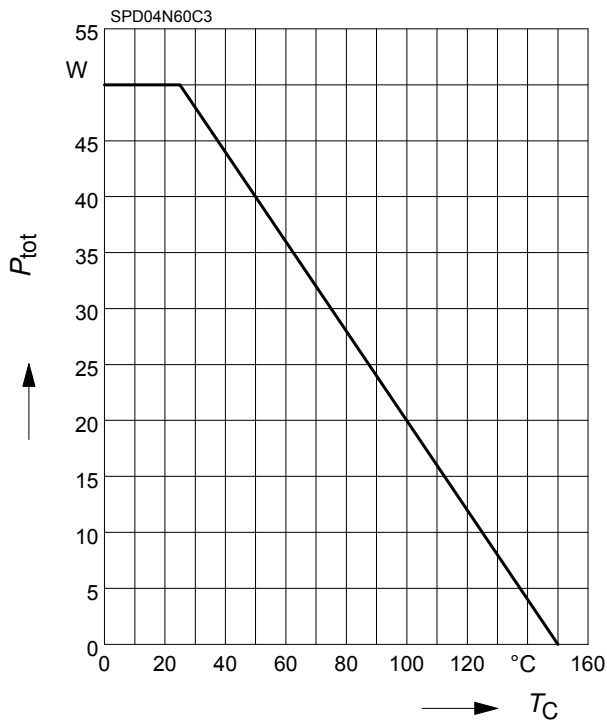

### 2 Safe operating area

$$I_D = f(V_{DS})$$

parameter :  $D = 0$  ,  $T_C = 25^\circ\text{C}$

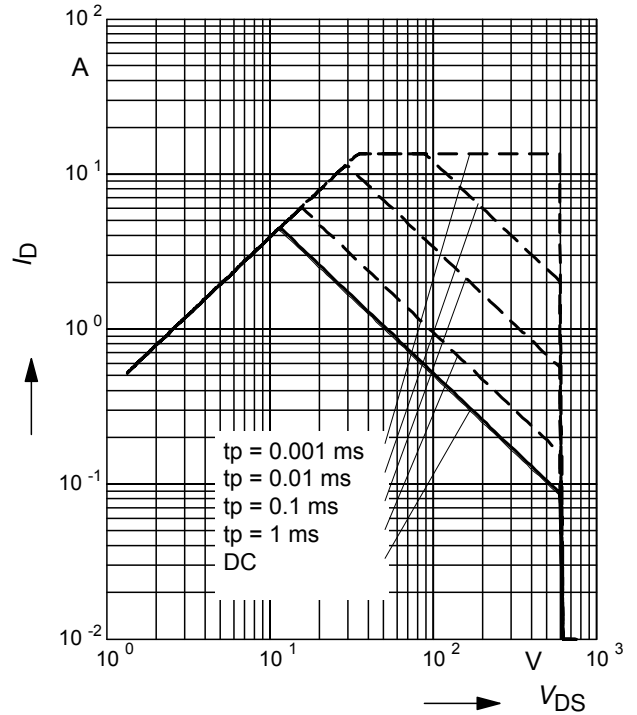

### 3 Transient thermal impedance

$$Z_{thJC} = f(t_p)$$

parameter:  $D = t_p/T$

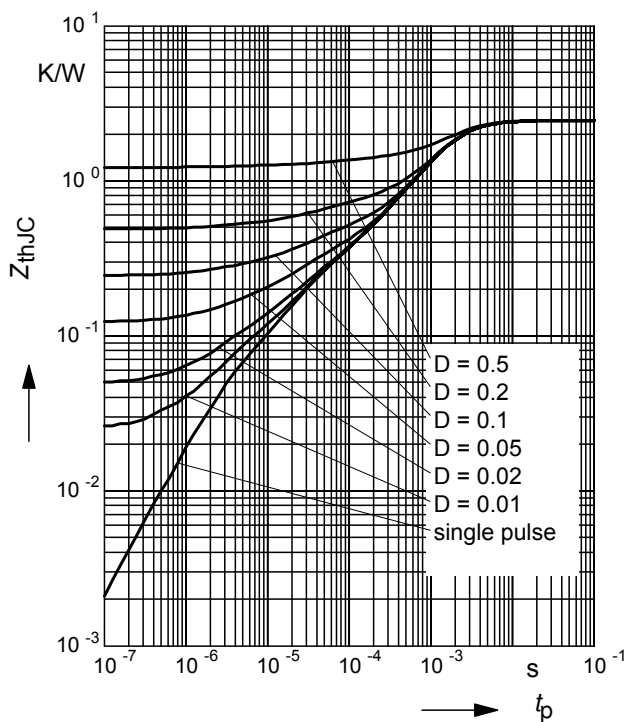

### 4 Typ. output characteristic

$$I_D = f(V_{DS}); T_j = 25^\circ\text{C}$$

parameter:  $t_p = 10 \mu\text{s}$ ,  $V_{GS}$

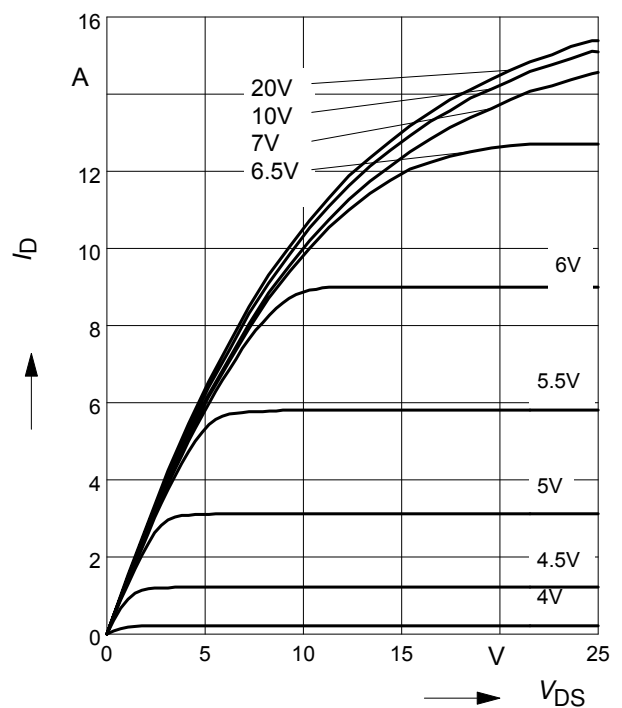

**5 Typ. output characteristic**

$I_D = f(V_{DS}); T_j = 150^\circ\text{C}$

parameter:  $t_p = 10 \mu\text{s}, V_{GS}$

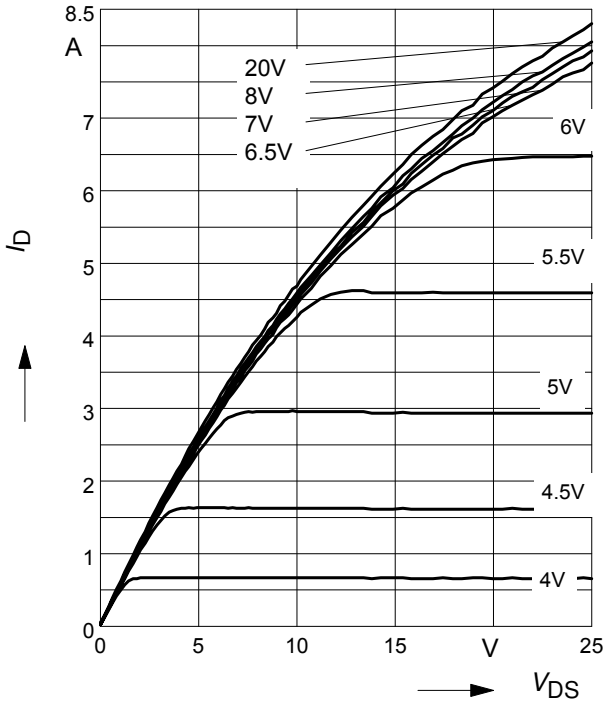

**6 Typ. drain-source on resistance**

$R_{DS(on)} = f(I_D)$

parameter:  $T_j = 150^\circ\text{C}, V_{GS}$

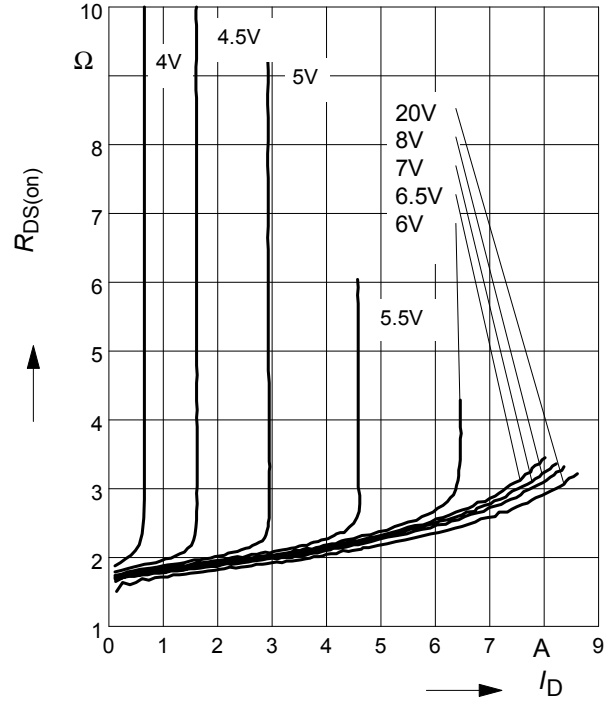

**7 Drain-source on-state resistance**

$R_{DS(on)} = f(T_j)$

parameter:  $I_D = 2.8 \text{ A}, V_{GS} = 10 \text{ V}$

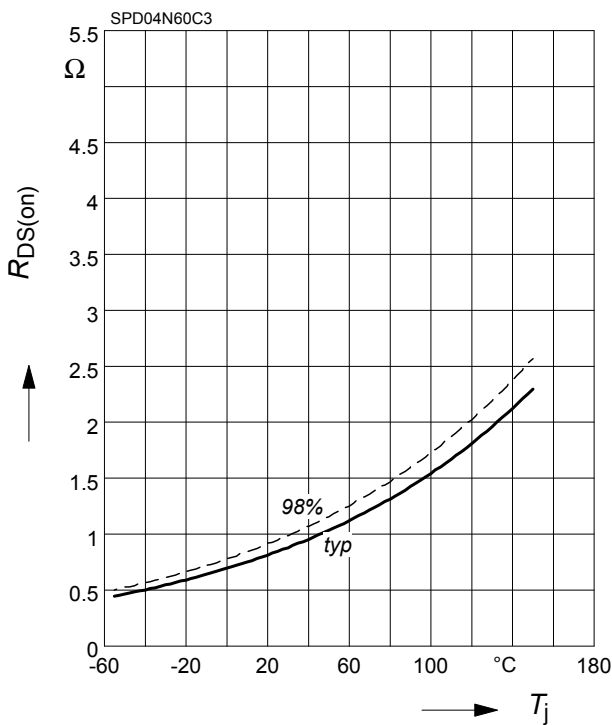

**8 Typ. transfer characteristics**

$I_D = f(V_{GS}); V_{DS} \geq 2 \times I_D \times R_{DS(on)max}$

parameter:  $t_p = 10 \mu\text{s}$

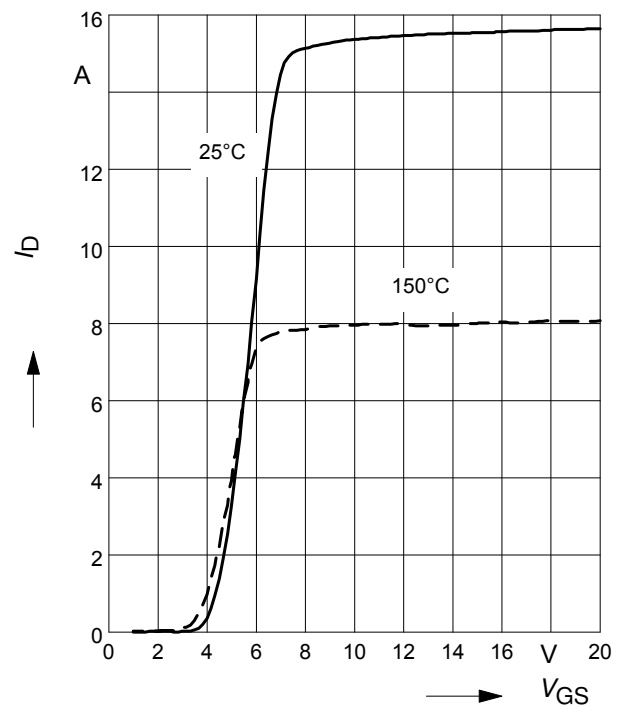

### 9 Typ. gate charge

$$V_{GS} = f(Q_{Gate})$$

parameter:  $I_D = 4.5$  A pulsed

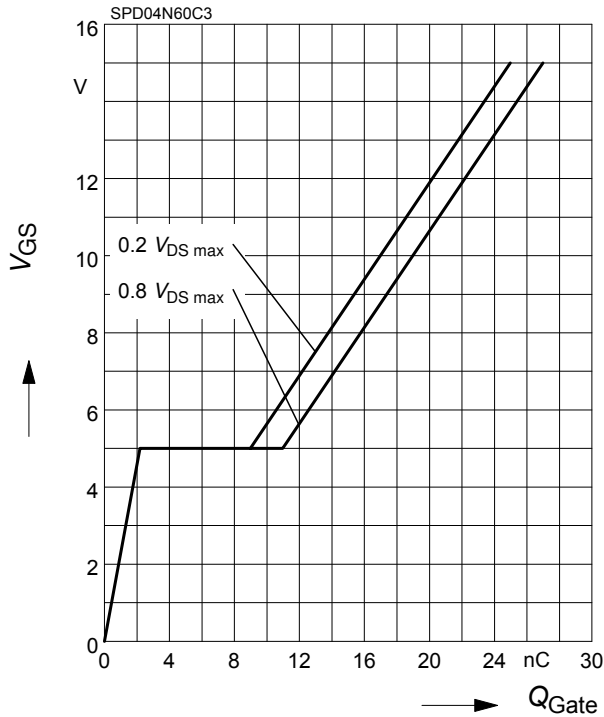

### 10 Forward characteristics of body diode

$$I_F = f(V_{SD})$$

parameter:  $T_j, t_p = 10$   $\mu$ s

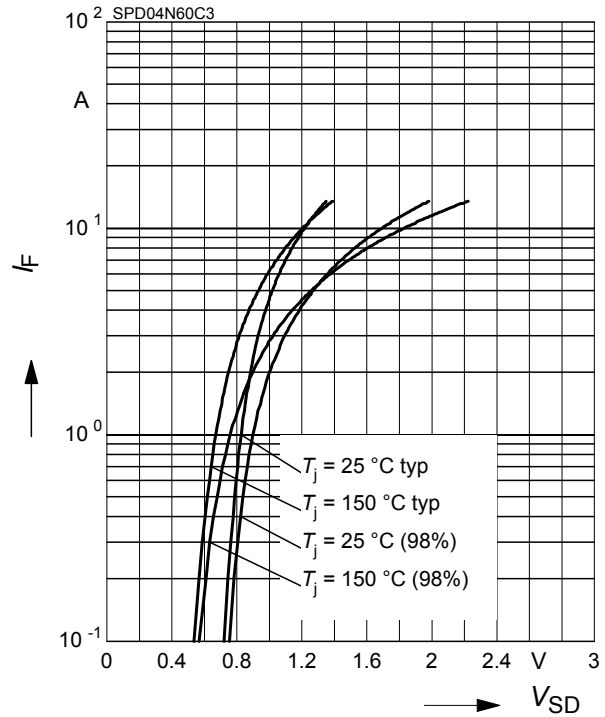

### 11 Typ. drain current slope

$$di/dt = f(R_G), \text{ inductive load, } T_j = 125^\circ\text{C}$$

par.:  $V_{DS}=380$ V,  $V_{GS}=0/+13$ V,  $I_D=4.5$ A

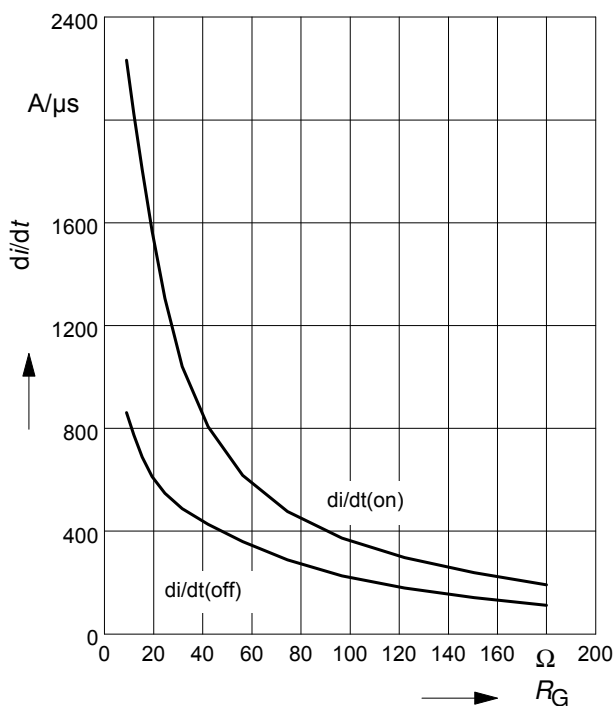

### 12 Typ. switching time

$$t = f(R_G), \text{ inductive load, } T_j=125^\circ\text{C}$$

par.:  $V_{DS}=380$ V,  $V_{GS}=0/+13$ V,  $I_D=4.5$  A

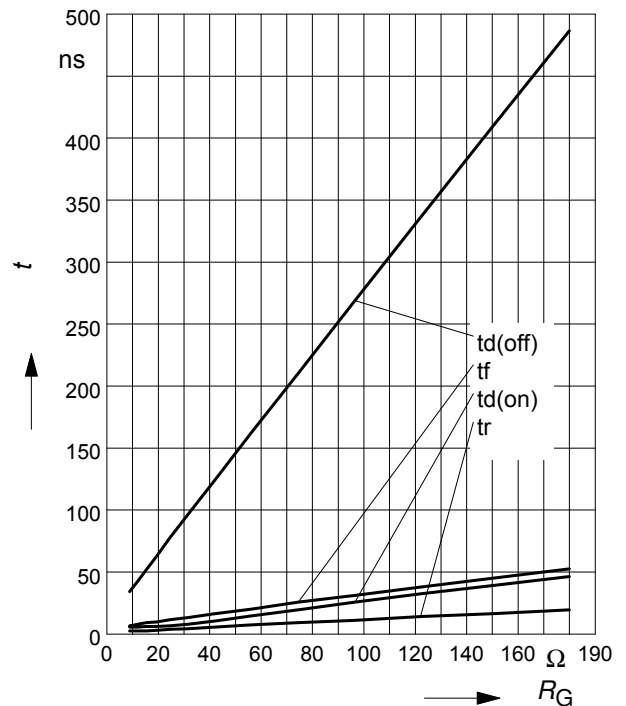

**13 Typ. switching time**

$t = f(I_D)$ , inductive load,  $T_j=125^\circ\text{C}$   
par.:  $V_{DS}=380\text{V}$ ,  $V_{GS}=0/+13\text{V}$ ,  $R_G=18\Omega$

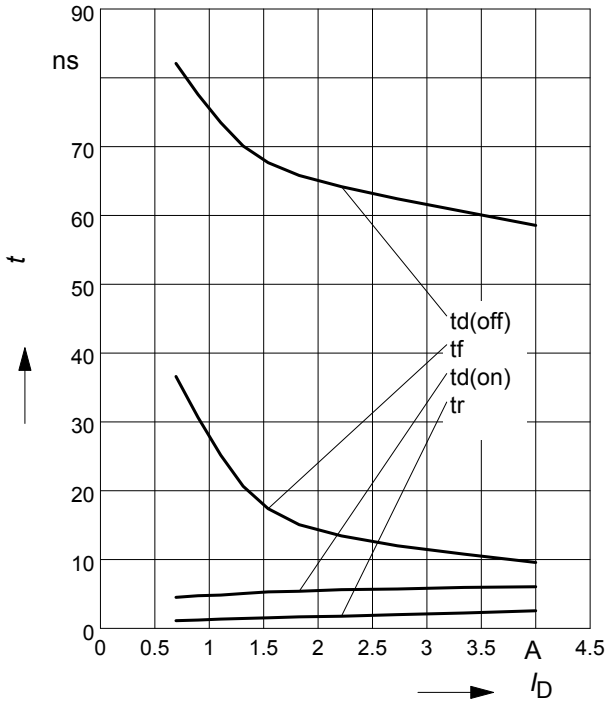

**14 Typ. drain source voltage slope**

$dv/dt = f(R_G)$ , inductive load,  $T_j = 125^\circ\text{C}$   
par.:  $V_{DS}=380\text{V}$ ,  $V_{GS}=0/+13\text{V}$ ,  $I_D=4.5\text{A}$

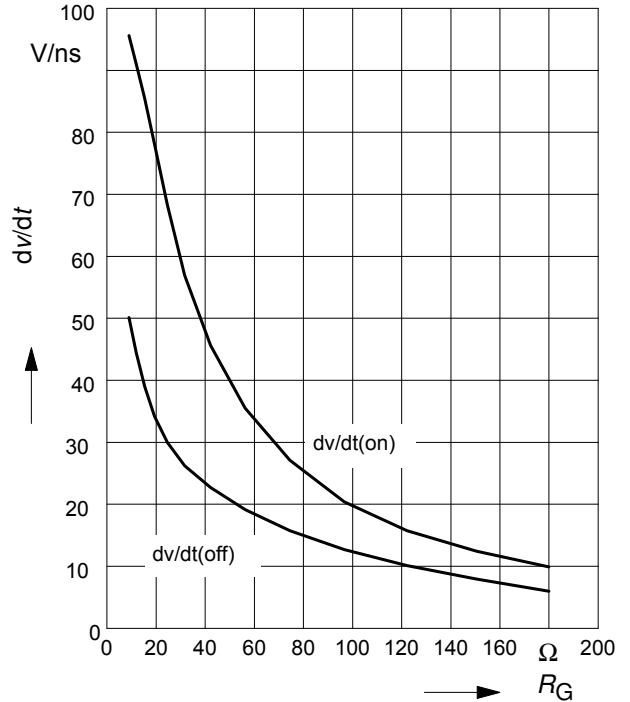

**15 Typ. switching losses**

$E = f(I_D)$ , inductive load,  $T_j=125^\circ\text{C}$   
par.:  $V_{DS}=380\text{V}$ ,  $V_{GS}=0/+13\text{V}$ ,  $R_G=18\Omega$

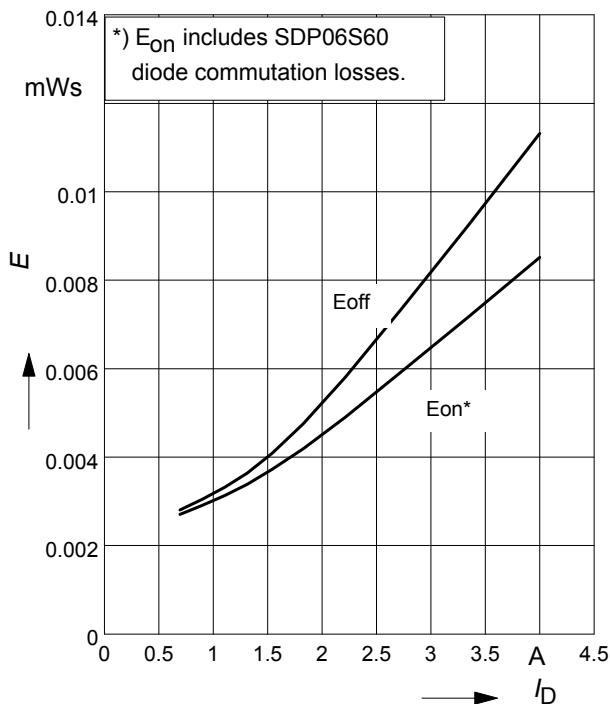

**16 Typ. switching losses**

$E = f(R_G)$ , inductive load,  $T_j=125^\circ\text{C}$   
par.:  $V_{DS}=380\text{V}$ ,  $V_{GS}=0/+13\text{V}$ ,  $I_D=4.5\text{A}$

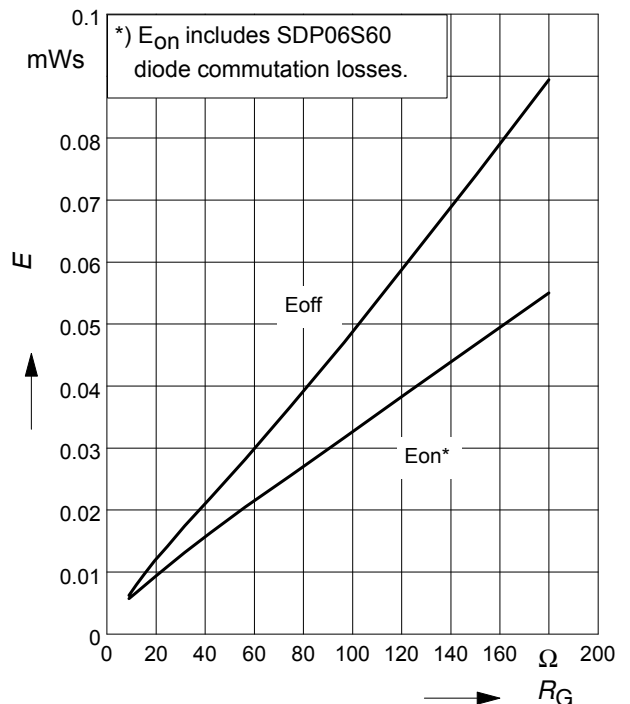



### 17 Avalanche SOA

$$I_{AR} = f(t_{AR})$$

par.:  $T_j \leq 150^\circ\text{C}$

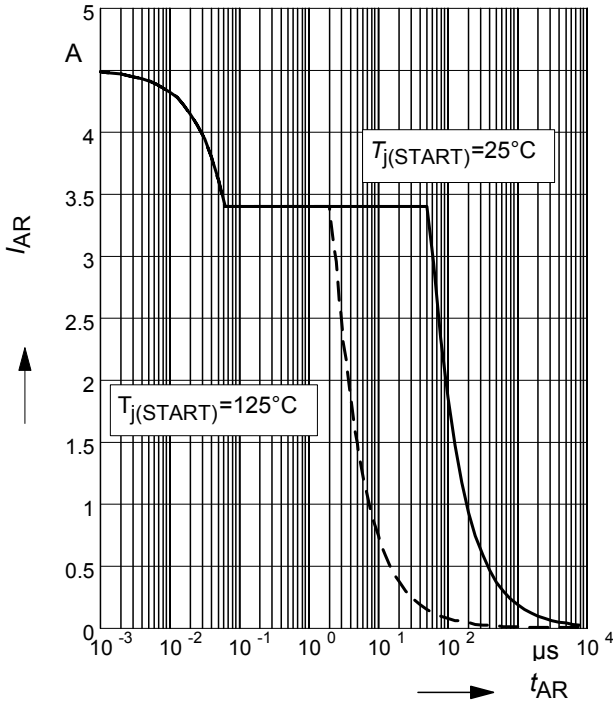

### 18 Avalanche energy

$$E_{AS} = f(T_j)$$

par.:  $I_D = 3.4\text{ A}$ ,  $V_{DD} = 50\text{ V}$

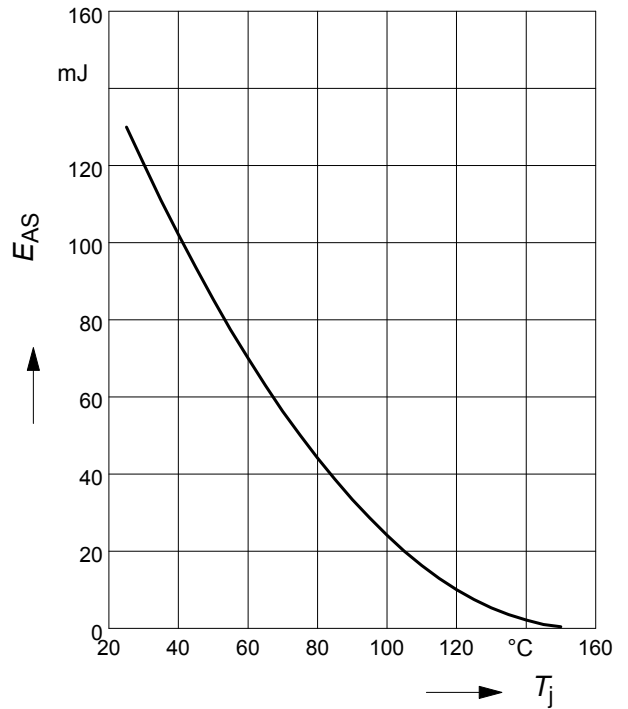

### 19 Drain-source breakdown voltage

$$V_{(BR)DSS} = f(T_j)$$

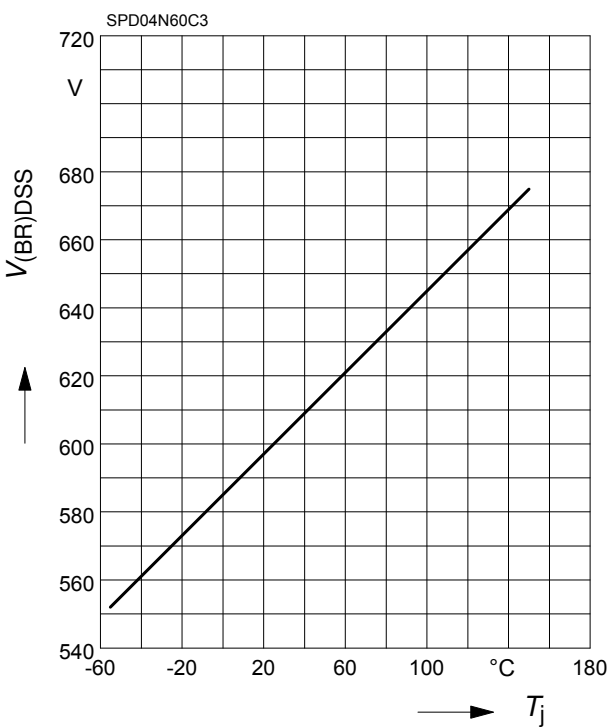

### 20 Avalanche power losses

$$P_{AR} = f(f)$$

parameter:  $E_{AR} = 0.4\text{ mJ}$

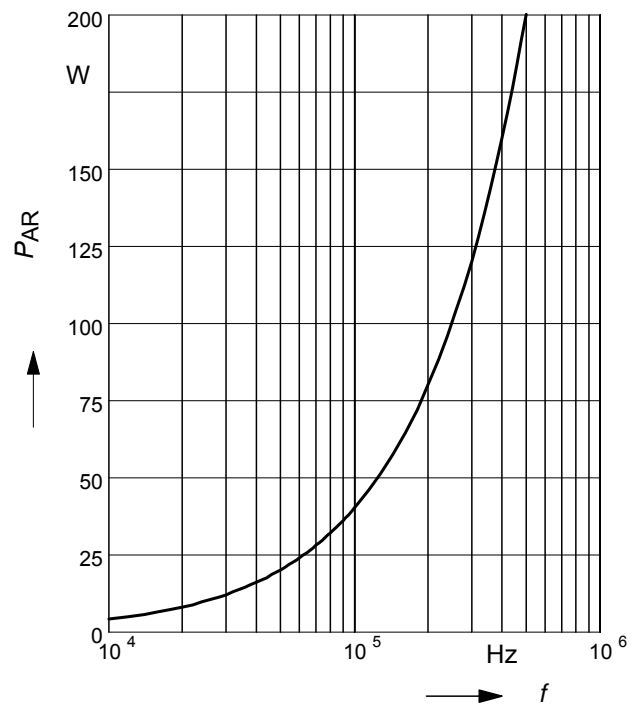

**21 Typ. capacitances**

$C = f(V_{DS})$

parameter:  $V_{GS}=0V, f=1\text{ MHz}$

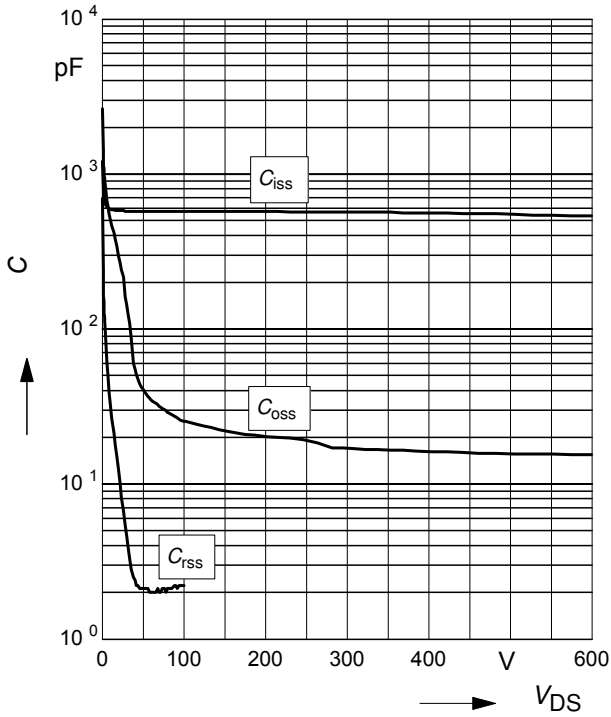

**22 Typ.  $C_{oss}$  stored energy**

$E_{oss} = f(V_{DS})$

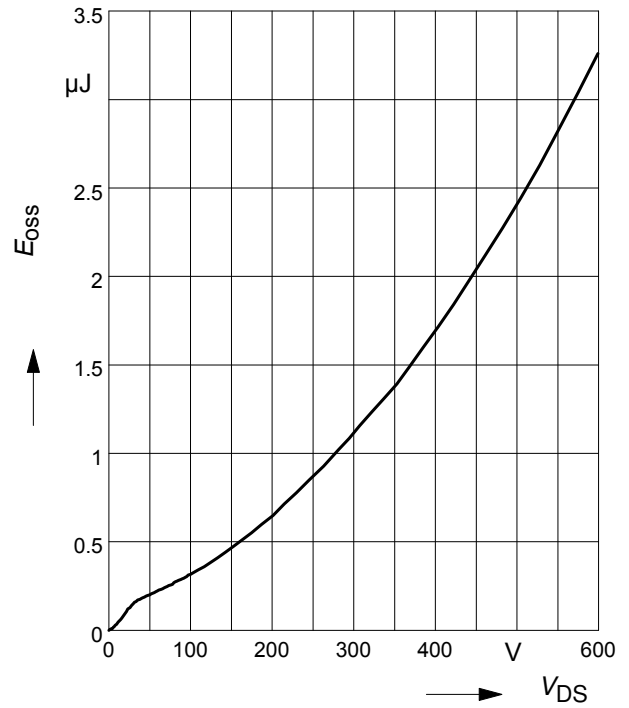

**Definition of diodes switching characteristics**

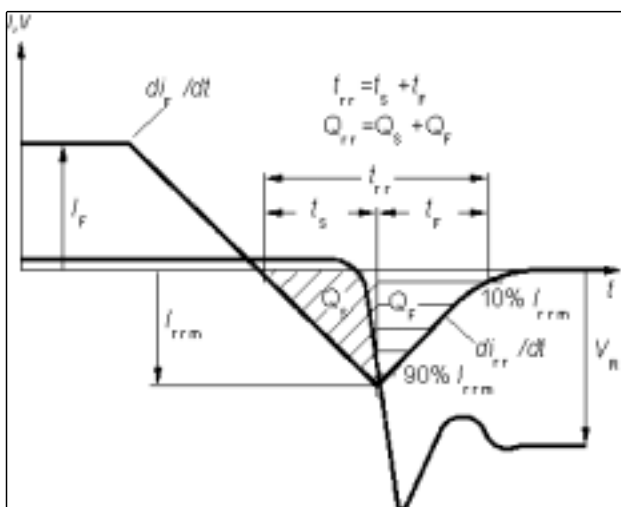

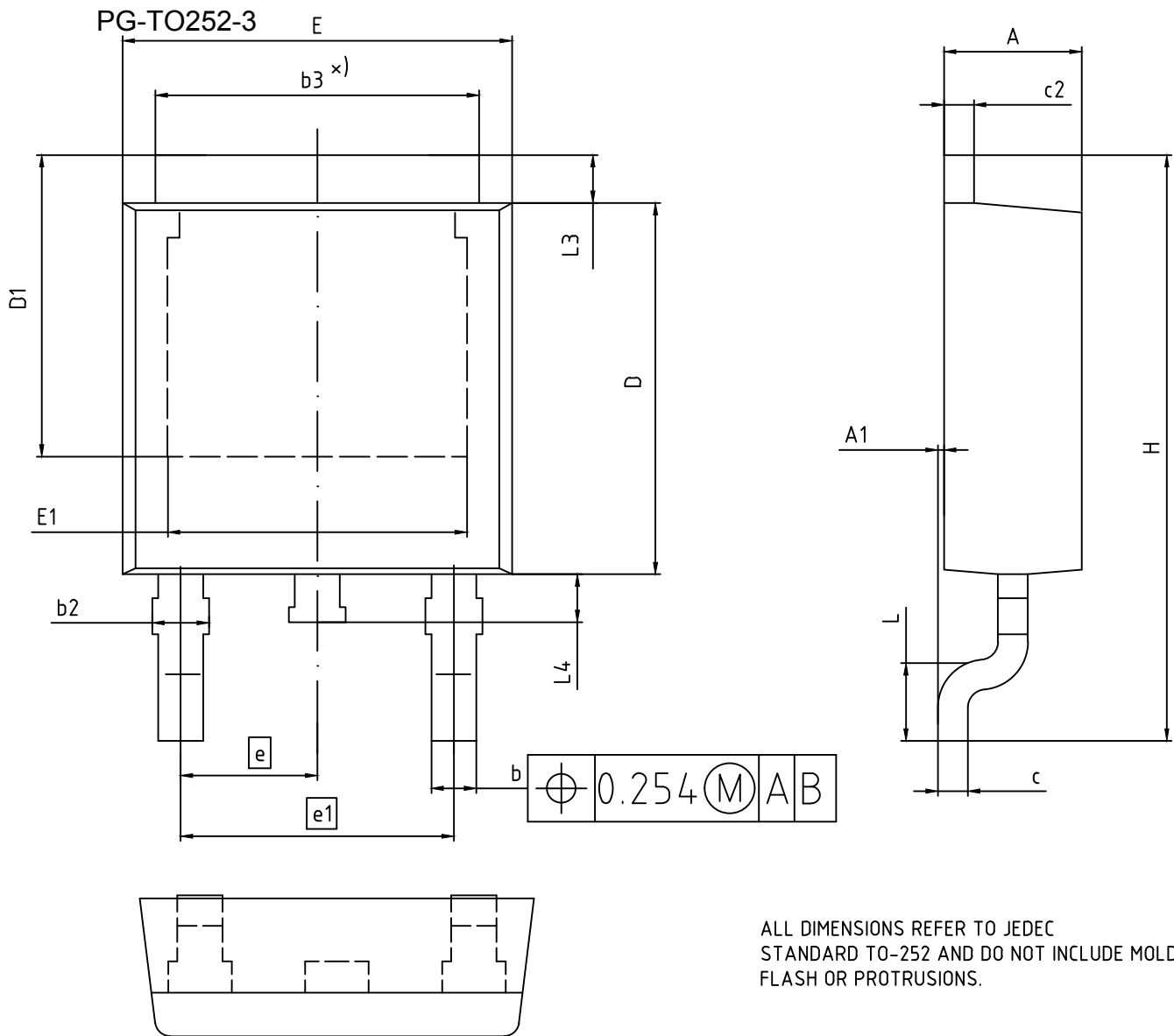

ALL DIMENSIONS REFER TO JEDEC STANDARD TO-252 AND DO NOT INCLUDE MOLD FLASH OR PROTRUSIONS.

DIMENSION	MILLIMETERS	
	MIN.	MAX.
A	2.16	2.41
A1	0.00	0.15
b	0.64	0.89
b2	0.65	1.15
b3	4.95	5.50
c	0.46	0.61
c2	0.40	0.98
D	5.97	6.22
D1	5.02	5.84
E	6.35	6.73
E1	4.32	5.50
e	2.29	
e1	4.57	
N	3	
H	9.40	10.48
L	1.18	1.78
L3	0.89	1.27
L4	0.51	1.02

<b>DOCUMENT NO.</b> Z8B00003328
<b>REVISION</b> 07
<b>SCALE:</b> 10:1 0 1 2mm 
<b>EUROPEAN PROJECTION</b> 
<b>ISSUE DATE</b> 01.04.2020

PG-TO251-3

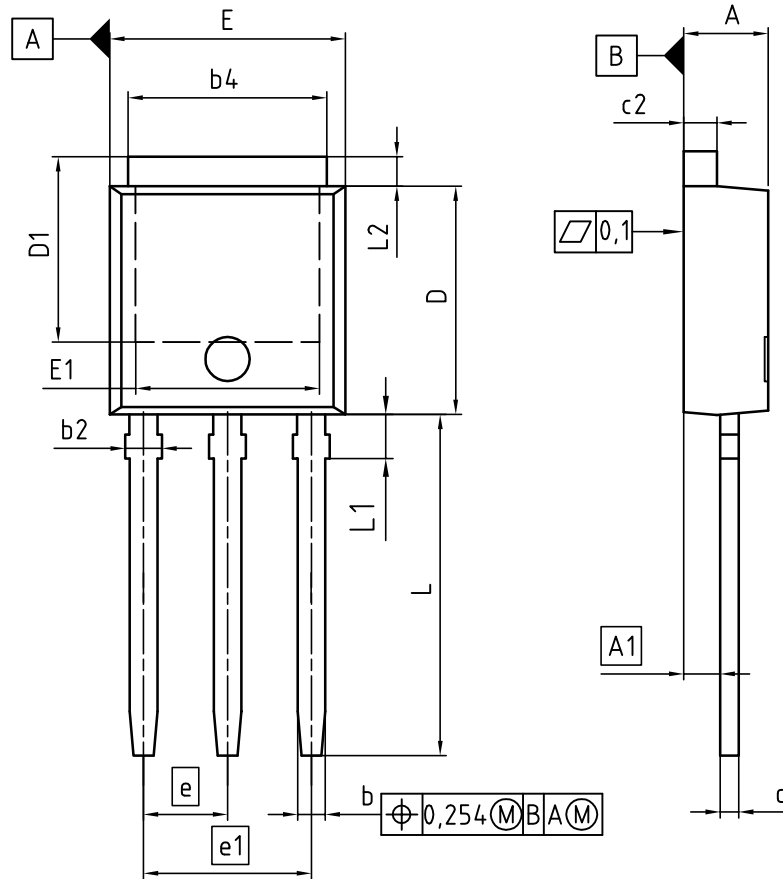

DIM	MILLIMETERS		INCHES	
	MIN	MAX	MIN	MAX
A	2.16	2.41	0.085	0.095
A1	0.90	1.14	0.035	0.045
b	0.64	0.89	0.025	0.035
b2	0.65	1.15	0.026	0.045
b4	4.95	5.50	0.195	0.217
c	0.46	0.60	0.018	0.024
c2	0.46	0.89	0.018	0.035
D	5.97	6.22	0.235	0.245
D1	5.04	5.77	0.198	0.227
E	6.35	6.73	0.250	0.265
E1	4.70	5.21	0.185	0.205
e	2.29		0.090	
e1	4.57		0.180	
N	3		3	
L	8.89	9.65	0.350	0.380
L1	1.90	2.29	0.075	0.090
L2	0.89	1.37	0.035	0.054

DOCUMENT NO.  
DZ80001310

SCALE

EUROPEAN PROJECTION

ISSUE DATE  
19-03-2008

REVISION  
03

## Revision History

SPD04N60C3

**Revision: 2020-05-26, Rev. 2.6**

Previous Revision

Revision	Date	Subjects (major changes since last revision)
2.6	2020-05-26	Update package outline

### Trademarks

All referenced product or service names and trademarks are the property of their respective owners.

### We Listen to Your Comments

Any information within this document that you feel is wrong, unclear or missing at all? Your feedback will help us to continuously improve the quality of this document. Please send your proposal (including a reference to this document) to:

[erratum@infineon.com](mailto:erratum@infineon.com)

### Published by

**Infineon Technologies AG**  
**81726 München, Germany**  
**© 2020 Infineon Technologies AG**  
**All Rights Reserved.**

### Legal Disclaimer

The information given in this document shall in no event be regarded as a guarantee of conditions or characteristics ("Beschaffungsgarantie").

With respect to any examples, hints or any typical values stated herein and/or any information regarding the application of the product, Infineon Technologies hereby disclaims any and all warranties and liabilities of any kind, including without limitation warranties of non-infringement of intellectual property rights of any third party.

In addition, any information given in this document is subject to customer's compliance with its obligations stated in this document and any applicable legal requirements, norms and standards concerning customer's products and any use of the product of Infineon Technologies in customer's applications.

The data contained in this document is exclusively intended for technically trained staff. It is the responsibility of customer's technical departments to evaluate the suitability of the product for the intended application and the completeness of the product information given in this document with respect to such application.

### Information

For further information on technology, delivery terms and conditions and prices please contact your nearest Infineon Technologies Office ([www.infineon.com](http://www.infineon.com)).

### Warnings

Due to technical requirements, components may contain dangerous substances. For information on the types in question, please contact the nearest Infineon Technologies Office.

The Infineon Technologies component described in this Data Sheet may be used in life-support devices or systems and/or automotive, aviation and aerospace applications or systems only with the express written approval of Infineon Technologies, if a failure of such components can reasonably be expected to cause the failure of that life-support, automotive, aviation and aerospace device or system or to affect the safety or effectiveness of that device or system. Life support devices or systems are intended to be implanted in the human body or to support and/or maintain and sustain and/or protect human life. If they fail, it is reasonable to assume that the health of the user or other persons may be endangered.