

ISL55014

MMIC Silicon Bipolar Broadband Amplifier

FN6259
Rev.1.00
Jul 20, 2017

The [ISL55014](#) is a high performance gain block featuring a Darlington configuration using high f_T transistors and excellent thermal performance. They are an ideal choice for DVB-S LNB cable receiver applications.

Other members of the family includes:

- ISL55012 and ISL55015 match a 75Ω source to a 50Ω load.
- ISL55014 matches a 50Ω source to a 50Ω load.

Ordering Information

PART # (Notes 1, 2, 3)	PART MARKING (Note 4)	TAPE AND REEL (UNITS)	PACKAGE (RoHS COMPLIANT)	PKG. DWG. #
ISL55014IEZ-T7	CCJ	3k	6 Ld SC-70	P6.049A

NOTES:

1. Refer to [TB347](#) for details on reel specifications.
2. These Intersil Pb-free plastic packaged products employ special Pb-free material sets, molding compounds/die attach materials, and 100% matte tin plate plus anneal (e3 termination finish, which is RoHS compliant and compatible with both SnPb and Pb-free soldering operations). Intersil Pb-free products are MSL classified at Pb-free peak reflow temperatures that meet or exceed the Pb-free requirements of IPC/JEDEC J STD-020.
3. For Moisture Sensitivity Level (MSL), see product information page for [ISL55014](#). For more information on MSL, see tech brief [TB363](#).
4. The part marking is located on the bottom of the part.

Related Literature

- For a full list of related documents, visit our website - [ISL55014](#) product page

Features

- Input impedance of 50Ω
- Output impedance of 50Ω
- Gain of 17.2dB at 1GHz
- Noise figure of 4.3dB
- OIP3 of 30dBm
- Low input and output return losses
- Pb-Free (RoHS compliant)

Applications

- LNB and LNB-T (HDTV) amplifiers
- IF gain blocks for satellite and terrestrial STBs
- PA driver amplifier
- Wireless data, satellite
- Bluetooth/WiFi
- Satellite locator and signal strength meters

Pin Configuration

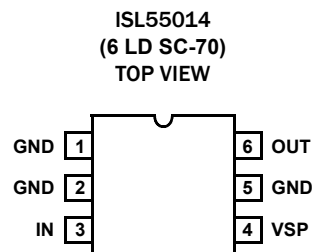

TOP VIEW
TOP VIEW
TOP VIEW

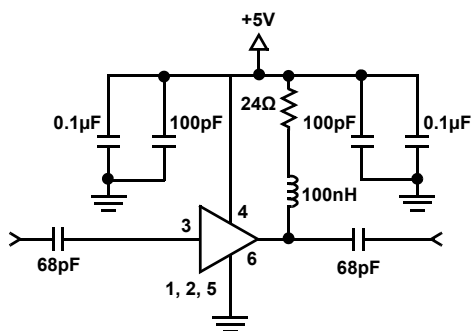

FIGURE 1. TYPICAL APPLICATION CIRCUIT

TABLE 1. KEY DIFFERENCES BETWEEN FAMILY OF PARTS

PART #	IMPEDANCE		GAIN AT 1GHz (dB)	NOISE FIGURE AT 2GHz (dB)
	SOURCE (Ω)	LOAD (Ω)		
ISL55012	75	50	18	4.7
ISL55014	50	50	17.2	4.3
ISL55015	75	50	13.5	4.8

Absolute Maximum Ratings ($T_A = +25^\circ\text{C}$)

Supply Voltage from V_{SP} to GND	6V
Input Voltage	$V_S + 0.3\text{V}$ to GND -0.3V
ESD Rating	
Human Body Model (Per MIL-STD-883 Method 3015.7)	6000V
Machine Model (Per EIAJ ED-4701 Method C-111)	300V

Thermal Information

Thermal Resistance (Typical)	θ_{JA} ($^\circ\text{C}/\text{W}$)	θ_{JC} ($^\circ\text{C}/\text{W}$)
6 Ld SC-70 (Notes 5, 6)	255	195
Storage Temperature	-65 $^\circ\text{C}$ to +125 $^\circ\text{C}$	
Operating Junction Temperature	+135 $^\circ\text{C}$	
Pb-Free Reflow Profile	see TB493	

Recommended Operating Conditions

Ambient Operating Temperature -40 $^\circ\text{C}$ to +85 $^\circ\text{C}$

CAUTION: Do not operate at or near the maximum ratings listed for extended periods of time. Exposure to such conditions may adversely impact product reliability and result in failures not covered by warranty.

NOTES:

- θ_{JA} is measured with the component mounted on a high-effective thermal conductivity test board in free air. See Tech Brief [TB379](#) for details.
- For θ_{JC} , the "case temp" location is taken at the package top center.

Electrical Specifications $V_{SP} = +5\text{V}$, $Z_{RSC} = Z_{LOAD} = 50\Omega$, $T_A = +25^\circ\text{C}$, 24 Ω V_{SP} to OUT, unless otherwise specified.

PARAMETER	SYMBOL	TEST CONDITIONS	MIN (Note 7)	TYP	MAX (Note 7)	UNIT
Supply Voltage	V_{SP}	To operate below 5V, the 24 Ω resistor to supply should be reduced	3.0		5.5	V
Small Signal Gain	Gt	1.0GHz	15.9	17.2	18.4	dB
		1.5GHz	15.5	16.7	18	dB
		2.0GHz	15.5	16.7	18	dB
Output Power at 1dB Compression	P1dB	1.0GHz	16	17.6	19.2	dBm
		2.0GHz	15.9	17.5	19.4	dBm
Output Third Order Intercept Point	OIP3	1.0GHz		30.3		dBm
		2.0GHz		25		dBm
Output Second Order Intercept Point	OIP2	Input tones at 1.0GHz and 1.1GHz, at input power = -15dBm, output tone 2.1GHz		43.8		dBm
3dB Bandwidth	BW	3dB below gain at 500MHz		2.75		GHz
Input Return Loss	IRL	1.0GHz		20.8		dB
Output Return Loss	ORL	1.0GHz		12.8		dB
Reverse Isolation	RISOL	2.0GHz		22.2		dB
Noise Figure	NF	2.0GHz		4.3		dB
Device Operating Current	ID		56	63	72	mA

NOTE:

- Parameters with MIN and/or MAX limits are 100% tested at +25 $^\circ\text{C}$, unless otherwise specified. Temperature limits established by characterization and are not production tested.

Device Test Setup

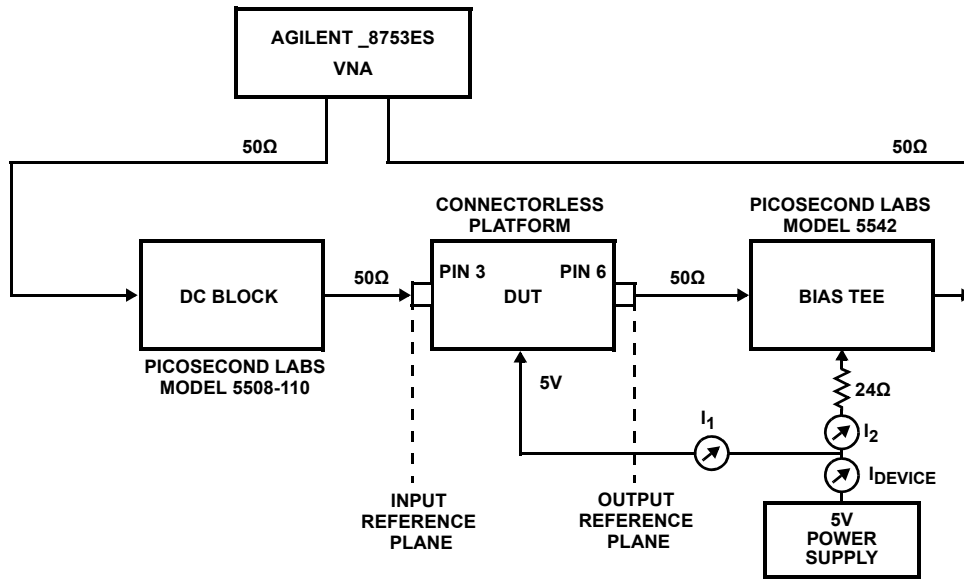

FIGURE 2. DEVICE TEST SETUP

Typical Performance Curves 50Ω environment

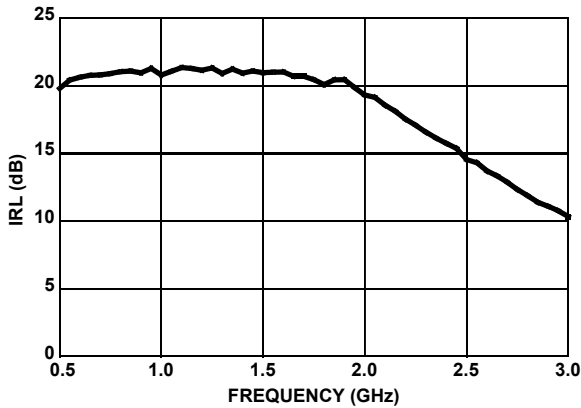

FIGURE 3. INPUT RETURN LOSS vs FREQUENCY

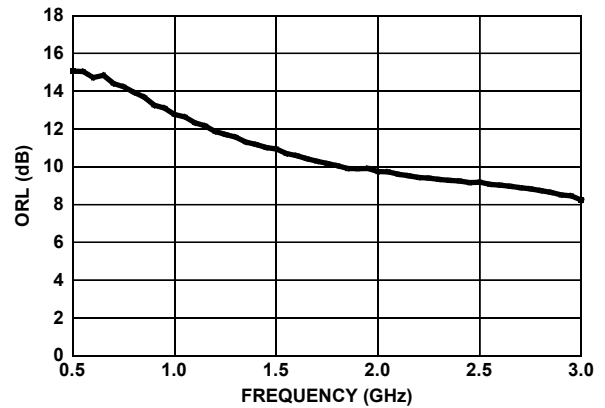

FIGURE 4. OUTPUT RETURN LOSS vs FREQUENCY

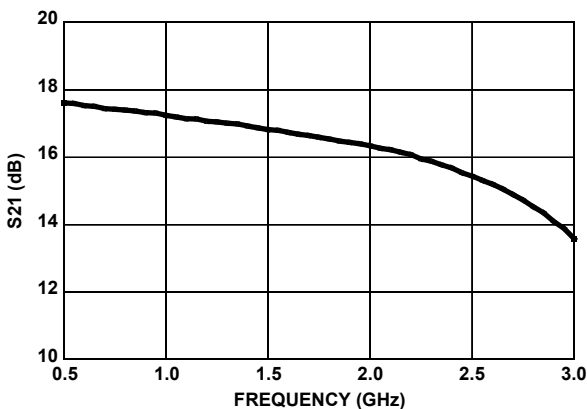

FIGURE 5. |S21| vs FREQUENCY

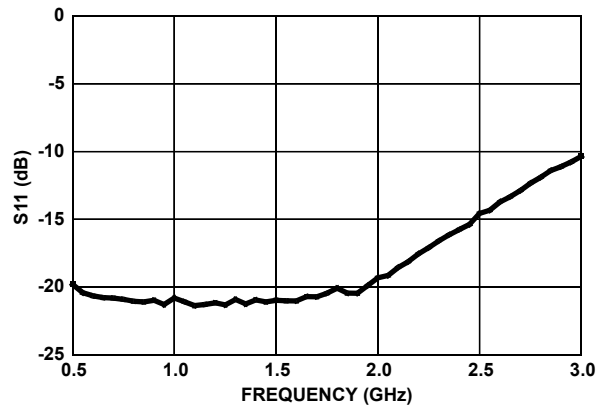

FIGURE 6. |S11| vs FREQUENCY

Typical Performance Curves 50Ω environment (Continued)

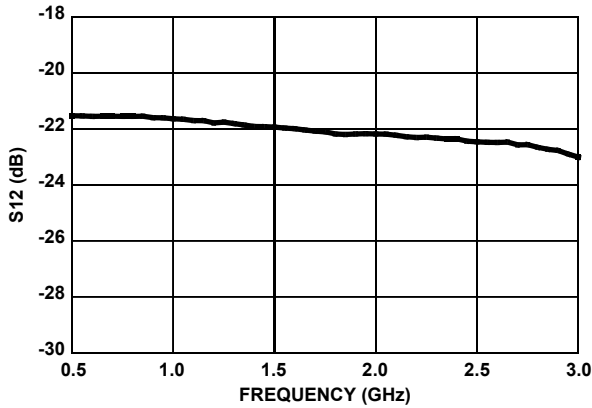

FIGURE 7. |S12| vs FREQUENCY

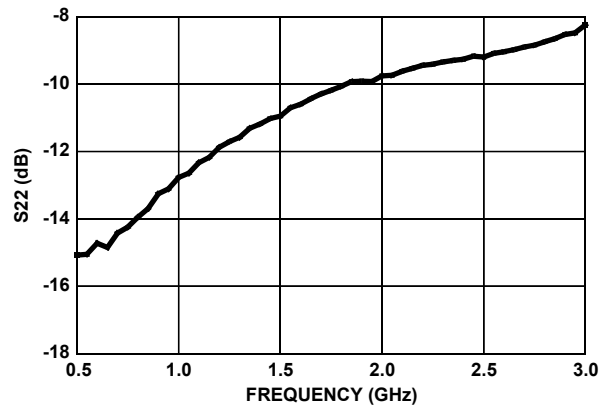

FIGURE 8. |S22| vs FREQUENCY

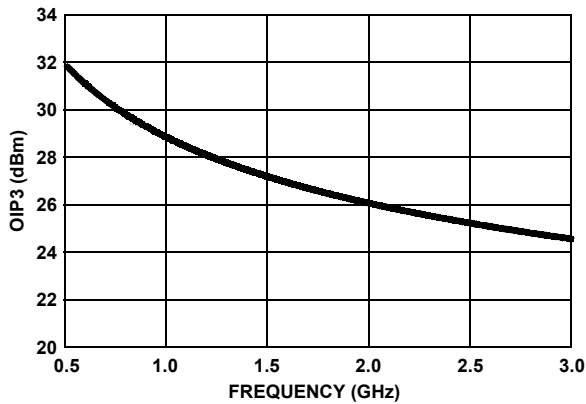

FIGURE 9. OIP3 vs FREQUENCY

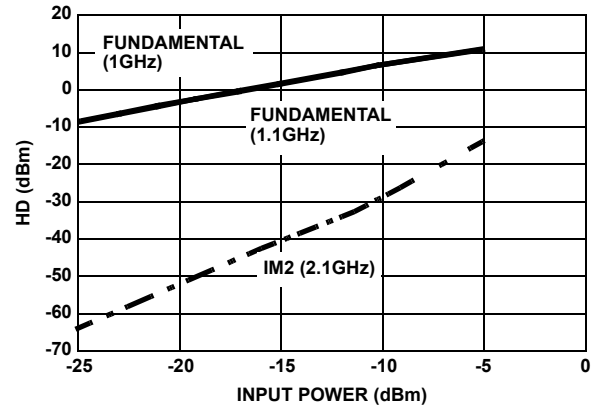

FIGURE 10. IM2 vs INPUT POWER

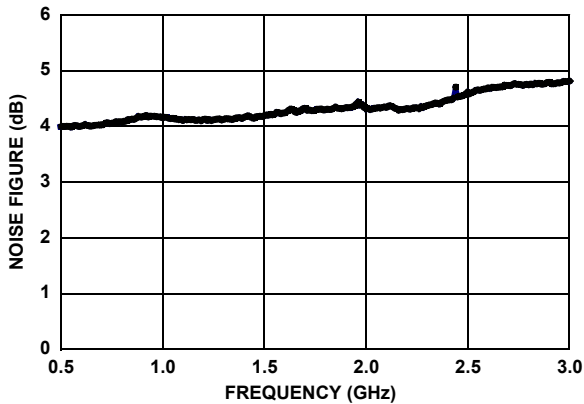

FIGURE 11. NOISE FIGURE vs FREQUENCY

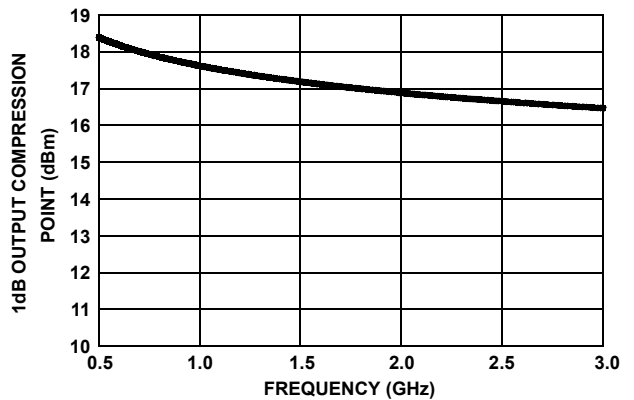

FIGURE 12. P1dB vs FREQUENCY

Typical Performance Curves 50Ω environment (Continued)

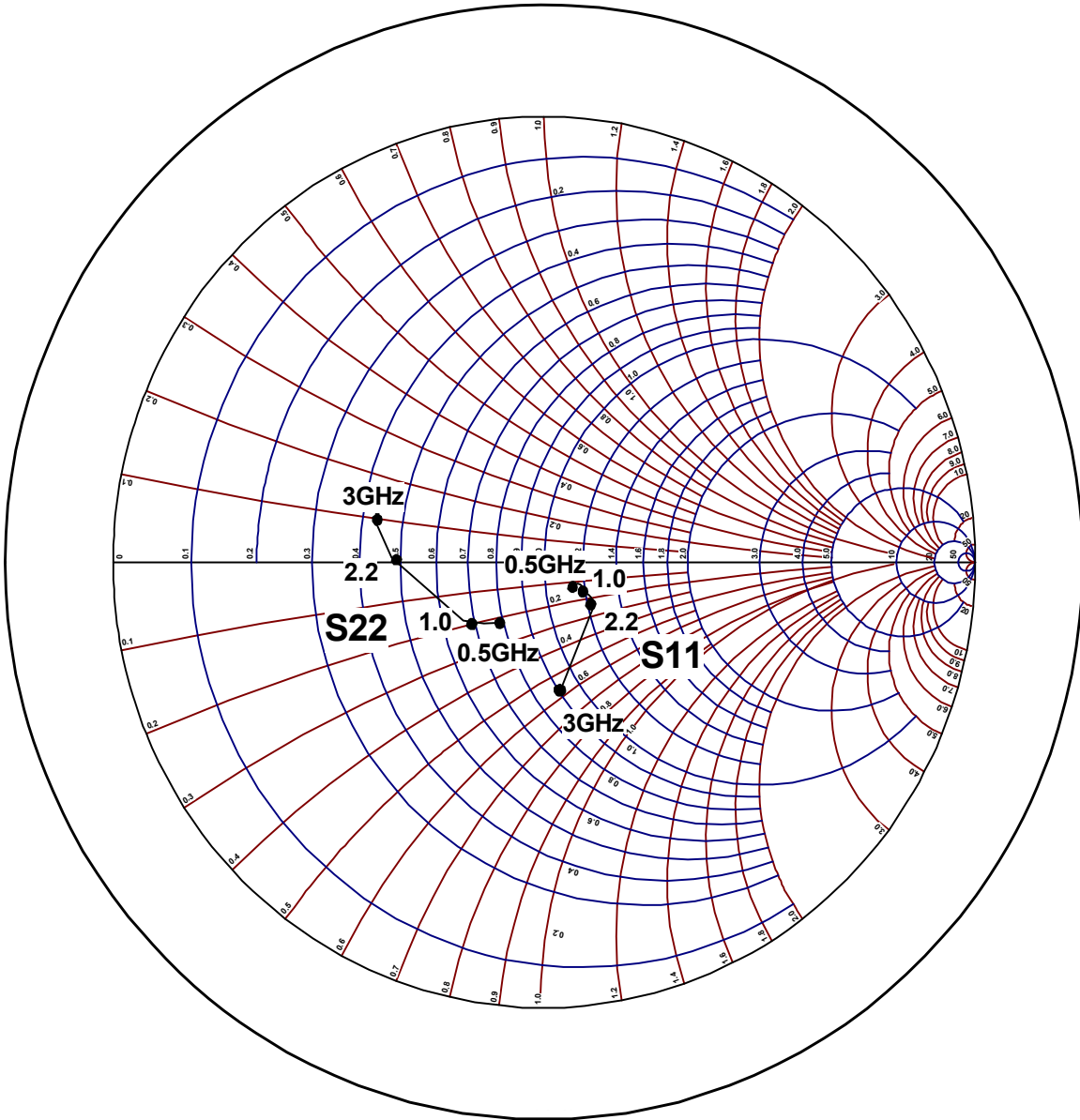

FIGURE 13. S11 AND S22 vs FREQUENCY

Revision History

The revision history provided is for informational purposes only and is believed to be accurate, but not warranted. Please visit our website to make sure you have the latest revision.

DATE	REVISION	CHANGE
Jul 20, 2017	FN6259.1	<p>-Removed mention of obsolete part ISL55013.</p> <p>Changes on page 1:</p> <p>-Updated Ordering Information table</p> <p>-Added Notes 1 and 3. Added Related Literature and Table of Differences.</p> <p>Changes on page 2:</p> <p>-Updated θ_{JA} from: 200 to θ_{JA} 255 and added θ_{JC} 195. Added corresponding Notes 5 and 6.</p> <p>-Moved Storage Temperature and Operating Junction Temperature from Abs Max to Thermal Information section.</p> <p>-Added Recommended Operating Conditions section and moved Ambient Operating Temperature to this section from Abs Max.</p> <p>-Added Revision History and About Intersil sections.</p> <p>Changed POD on page 7 from P6.049A to P6.049B.</p>

About Intersil

Intersil Corporation is a leading provider of innovative power management and precision analog solutions. The company's products address some of the largest markets within the industrial and infrastructure, mobile computing, and high-end consumer markets.

For the most updated datasheet, application notes, related documentation, and related parts, see the respective product information page found at www.intersil.com.

For a listing of definitions and abbreviations of common terms used in our documents, visit: www.intersil.com/glossary.

You may report errors or suggestions for improving this datasheet by visiting www.intersil.com/ask.

Reliability reports are also available from our website at www.intersil.com/support.

© Copyright Intersil Americas LLC 2017. All Rights Reserved.

All trademarks and registered trademarks are the property of their respective owners.

For additional products, see www.intersil.com/en/products.html

Intersil products are manufactured, assembled and tested utilizing ISO9001 quality systems as noted in the quality certifications found at www.intersil.com/en/support/qualandreliability.html

Intersil products are sold by description only. Intersil may modify the circuit design and/or specifications of products at any time without notice, provided that such modification does not, in Intersil's sole judgment, affect the form, fit or function of the product. Accordingly, the reader is cautioned to verify that datasheets are current before placing orders. Information furnished by Intersil is believed to be accurate and reliable. However, no responsibility is assumed by Intersil or its subsidiaries for its use; nor for any infringements of patents or other rights of third parties which may result from its use. No license is granted by implication or otherwise under any patent or patent rights of Intersil or its subsidiaries.

For information regarding Intersil Corporation and its products, see www.intersil.com

Small Outline Transistor Plastic Packages (SC70-6)

P6.049B

6 LEAD SMALL OUTLINE TRANSISTOR PLASTIC PACKAGE

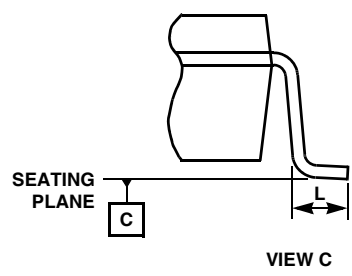
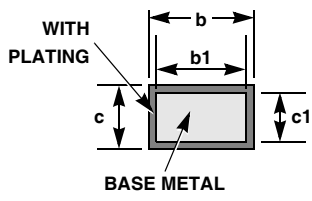
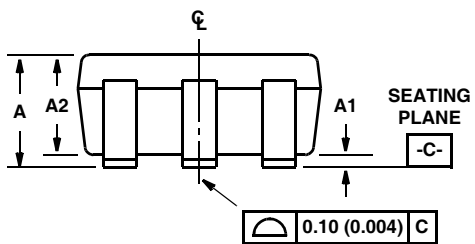
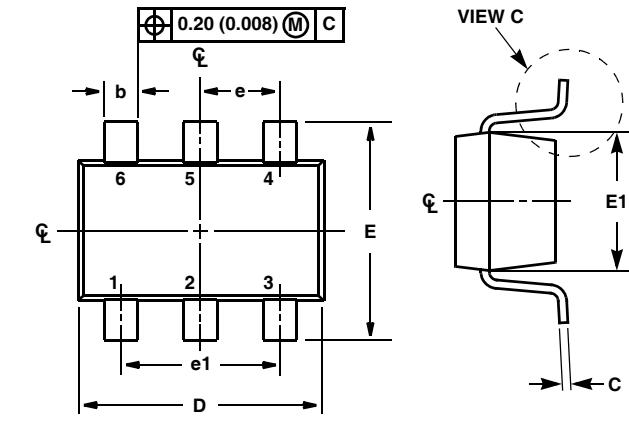

SYMBOL	MILLIMETERS		NOTES
	MIN	MAX	
A	0.80	1.00	-
A1	0.000	0.09	-
A2	0.80	0.91	-
b	0.15	0.30	-
b1	0.15	0.25	-
c	0.08	0.25	6
c1	0.10	0.15	6
D	1.85	2.25	3
E	2.30 BSC		-
E1	1.15	1.35	3
e	0.65 Ref		-
e1	1.30 Ref		-
L	0.21	0.44	4
N	6		5

Rev. 0 4/07

NOTES:

1. Dimensioning and tolerance per ASME Y14.5M-1994.
2. Package conforms to EIAJ SC70 and JEDEC MO203AB.
3. Dimensions D and E1 are exclusive of mold flash, protrusions, or gate burrs.
4. Footlength L measured at reference to gauge plane.
5. "N" is the number of terminal positions.
6. These Dimensions apply to the flat section of the lead between 0.08mm and 0.15mm from the lead tip.

For the most recent package outline drawing, see [P6.049B](#).